Item ID Number: 00091

Author Odum, Howard T.

Corporate Author Environmental Engineering Sciences, University of Florida, Gainesville, Florida; and Department of Biology, Center for Regional Environmental Problems, California State University, San Diego, California

Report/Article Title The Effects of Herbicides in South Vietnam: Part B, Working Papers, February 1974: Models of Herbicide, Mangroves, and War in Vietnam

Journal/Book Title

Year 1974

Month/Day February

Color []

Number of Images 305

Description Notes Subcontract No. BA23-72-28 December, 1973; Subcontract Report #5 Auxiliary Field Work Supported Under contract AT (04-3) - 807

C

79-779 031

THE EFFECTS OF HERBICIDES IN SOUTH VIETNAM
PART B. WORKING PAPERS: MODELS OF HERBICIDE
MANGROVES, AND WAR IN VIETNAM

NATIONAL ACADEMY OF SCIENCES-NATIONAL RESEARCH COUNCIL

FEBRUARY 1974

DISTRIBUTED BY:

NTIS
National Technical Information Service
U. S. DEPARTMENT OF COMMERCE

AD-779031

THE EFFECTS OF HERBICIDES IN SOUTH VIETNAM

PART B: WORKING PAPERS

FEBRUARY 1974

MODELS OF HERBICIDE, MANGROVES, AND WAR IN VIETNAM

HOWARD T. ODUM, MAURICE SELL, MARK BROWN, JAMES ZUCCHETTO,
CHARLES SWALLONS, JOAN BROWDER, T. AHLSTROM, AND L. PETERSON

NATIONAL ACADEMY OF SCIENCES - NATIONAL RESEARCH COUNCIL

WASHINGTON, D.D. 20418

Reproduced by
NATIONAL TECHNICAL
INFORMATION SERVICE
U S Department of Commerce
Springfield VA 22151

DISTRIBUTION STATEMENT A

Approved for public release;
Distribution Unlimited

D D C
RECEIVED
MAY 29 1974
D

305

MODELS OF HERBICIDE, MANGROVES, AND WAR IN VIETNAM

Final Report to National Research Council

Subcontract No. BA23-72-28

December, 1973

**Howard T. Odum, Maurice Sell, Mark Brown, James Zucchetto,
Charles Swallows, Joan Browder, T. Ahlstrom, and L. Peterson**

**Environmental Engineering Sciences
University of Florida
Gainesville 32601**

with Subcontract Report (#5) by

Philip C. Miller, James Ehrlinger, Barry Hynum, and Wayne Stoner

**Department of Biology, Center for Regional Environmental Problems,
California State University, San Diego, California 92115
with Auxiliary Field Work Supported Under AEC Contract AT (04-3) - 807**

Contents

1. Abstract
2. Introduction and Project Narrative
3. Model of Mangrove Productivity, Herbicide Spraying, Wood Cutting and Seedling Availability in the Rung Sat Zone of South Vietnam - M. Sell
4. Nutrient Models and Perspective on Mangrove Recovery in Rung Sat - J. Browder, T. Ahlstrom, and M. Sell
5. Digital Simulation of Potential Reforestation Problems in the Rung Sat Delta, Viet Nam - P. Miller, J. R. Ehrlinger, B. Hynum, and W. Stoner
6. Ordering and Disordering in South Vietnam by Energy Calculation - M. Brown
7. Simplified Simulation Model of Vietnam and the Impact of Herbicides - J. Zucchetto
8. A Simplified Simulation of the Impact of Herbicide and War on Productivity in Vietnam - C. Swallows
9. Effect of Aerial Application of Herbicides On a Mangrove Community in Southwest Florida - M. Sell
10. Effects of Herbicides on Ecosystems
11. Mangrove System Analysis - Appendix A - A. Lugo, M. Sell, and S. Snedaker

ABSTRACT

This is a final report of a contract between the Systems Ecology group of Environmental Engineering Sciences and the National Research Council for developing data models and simulation of herbicide, mangroves, and the relative role of these in the overall energy system of Viet Nam at war. Work started with a special conference on mangroves and models in June, 1972 from which a work plan evolved for models of recovery of mangroves of the Rung Sat district and a visit by H. T. Odum to Vung Tau. Simulations of the Rung Sat system showed serious delays in mangrove reforestation possible from seed shortages and shortage of seed trees due to high levels of wood cutting and extensive defoliation. Data on seedlings and other parameters from Viet Nam were supplemented with data from south Florida, where H. Tass conducted a herbicide spray test on Marco Island. Models of nutrient balance showed that loss of wood and leaves due to spraying removes a large fraction of available phosphorus but not a large fraction of available nitrogen. However, annual river flows in the Rung Sat situation bring in enough phosphorus for regrowth so that nutrient limitations do not seem to be limiting reforestation.

Under a subcontract extending thermal studies done in Florida, modeling initiative of the systems ecology group at San Diego, California showed high surface mud temperatures and dessication potentially inhibitory in much of the deforested mangrove area. Poor survival of planted seedlings in unshaded mud in Viet Nam suggest possible importance of these factors.

Simulations of two simplified models of Viet Nam as a whole suggest a pulse of overall war disruption followed by a stimulated recovery, the energy loss during a 20-year period being about 1X. Perspective from comparing energy flows showed an impact of herbicide as 2% of the energy budget of Viet Nam in years of spraying, a greater effect than the rest of the war's disruption.

Thus models and measurements were used to estimate relative factor magnitudes and times of recovery and to show perspective of the herbicide spray in the overall pattern of Viet Nam.

INTRODUCTION AND PROJECT NARRATIVE

Systems modelling and energy perspectives evaluations were needed by the National Research Council Committee for the Evaluation of Herbicide in Viet Nam for several purposes and a contract was arranged for the work to be done for these purposes:

1. Since modelling and simulation is regarded also as a research planning tool, our contract activity was also directed at clarifying questions, scanning knowledge and concepts among specialists concerned with mangroves and war models for the general input to the main committee. Thus, as contracted, a mangrove modelling conference was held in June, 1972 from which a number of special questions and needs were raised concerning planting of mangrove seedlings further testing of the sensitivity of mangrove communities and their roles following herbicide action. The results of the conference discussions, the additional literature search, the field data and the suggestions derived from planning models were fed back to the various deliberations of the main committee.

In the work with models a language of energy symbols was used. See Fig. 1. These are used to express differential equations. See also Odum, 1971. For example, the qualitative model in Fig. 2 was drawn to summarize committee discussions of important factors at a Puerto Rico meeting.

2. In the early examination of the questions about herbicide action, a special problem was identified in the mangrove districts as represented by the Rung Sat south of Saigon (Fig. 3). Here, the ground was remaining almost bare and vegetation did not seem to be coming back very rapidly. The committee arranged for various measurements to be made to verify the rate of recovery and test various hypotheses for the slow recovery. Among the possible limitations to

Figure 1

SOME SYMBOLS USED IN ENERGY CIRCUIT DIAGRAMS*

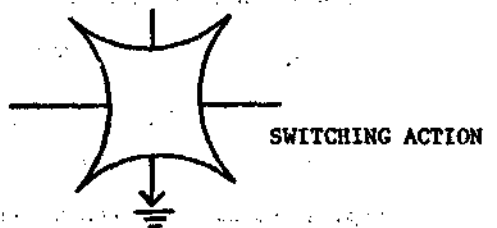
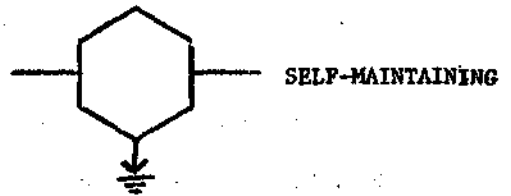
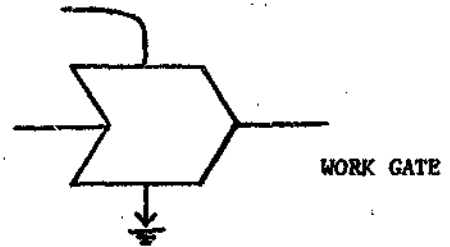
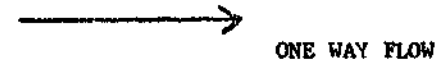
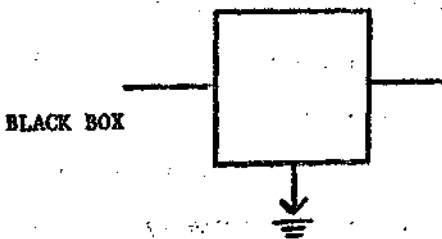
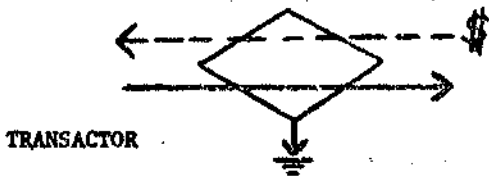
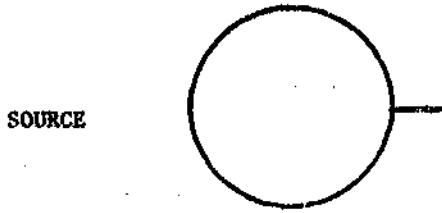
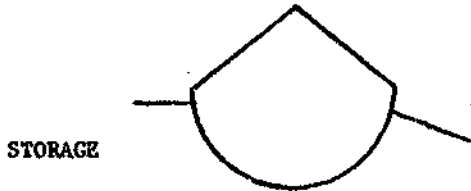

*More details may be shown within each symbol

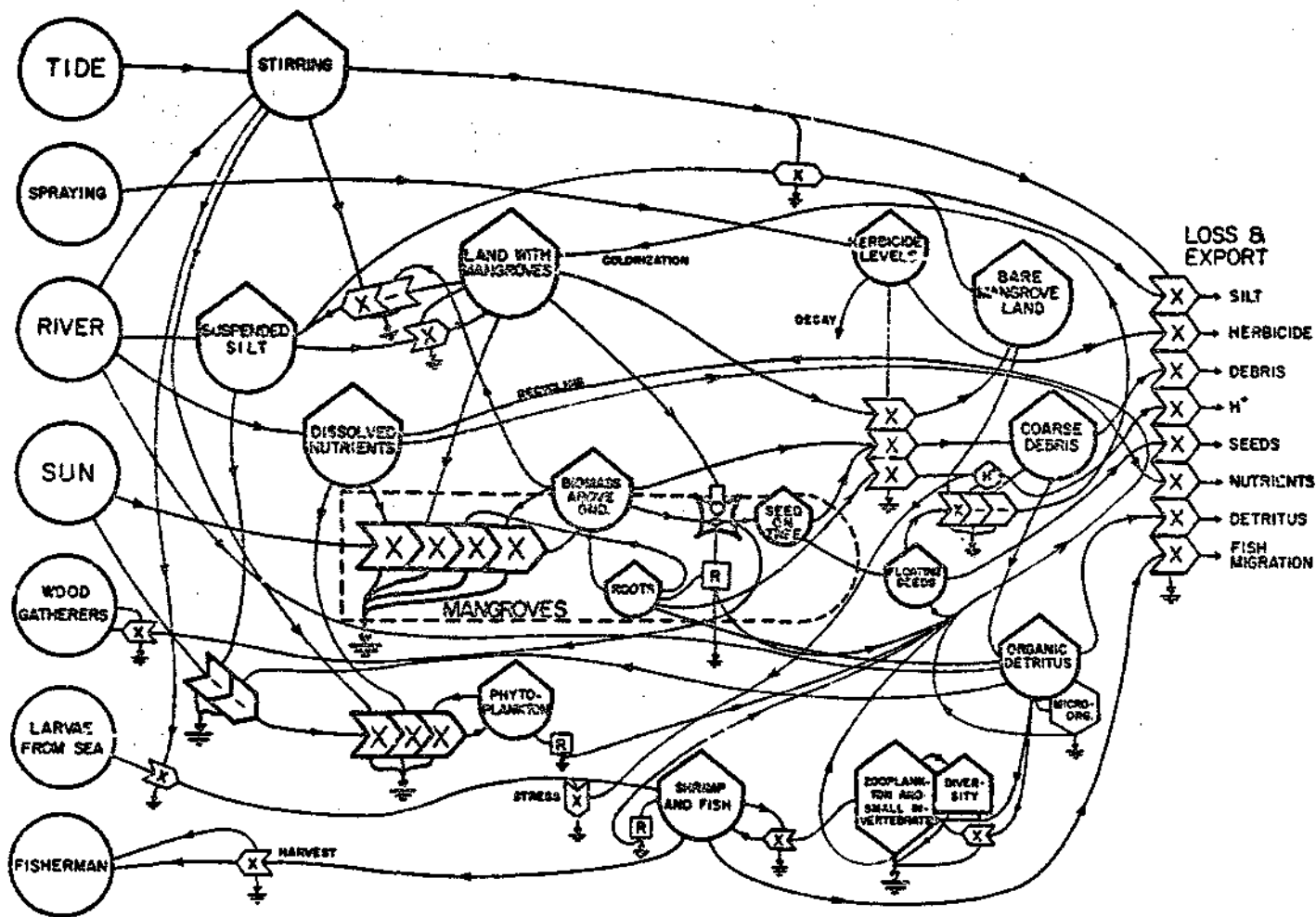

Figure 2

MODEL OF HERBICIDES IN MANGROVES IN VIETNAM

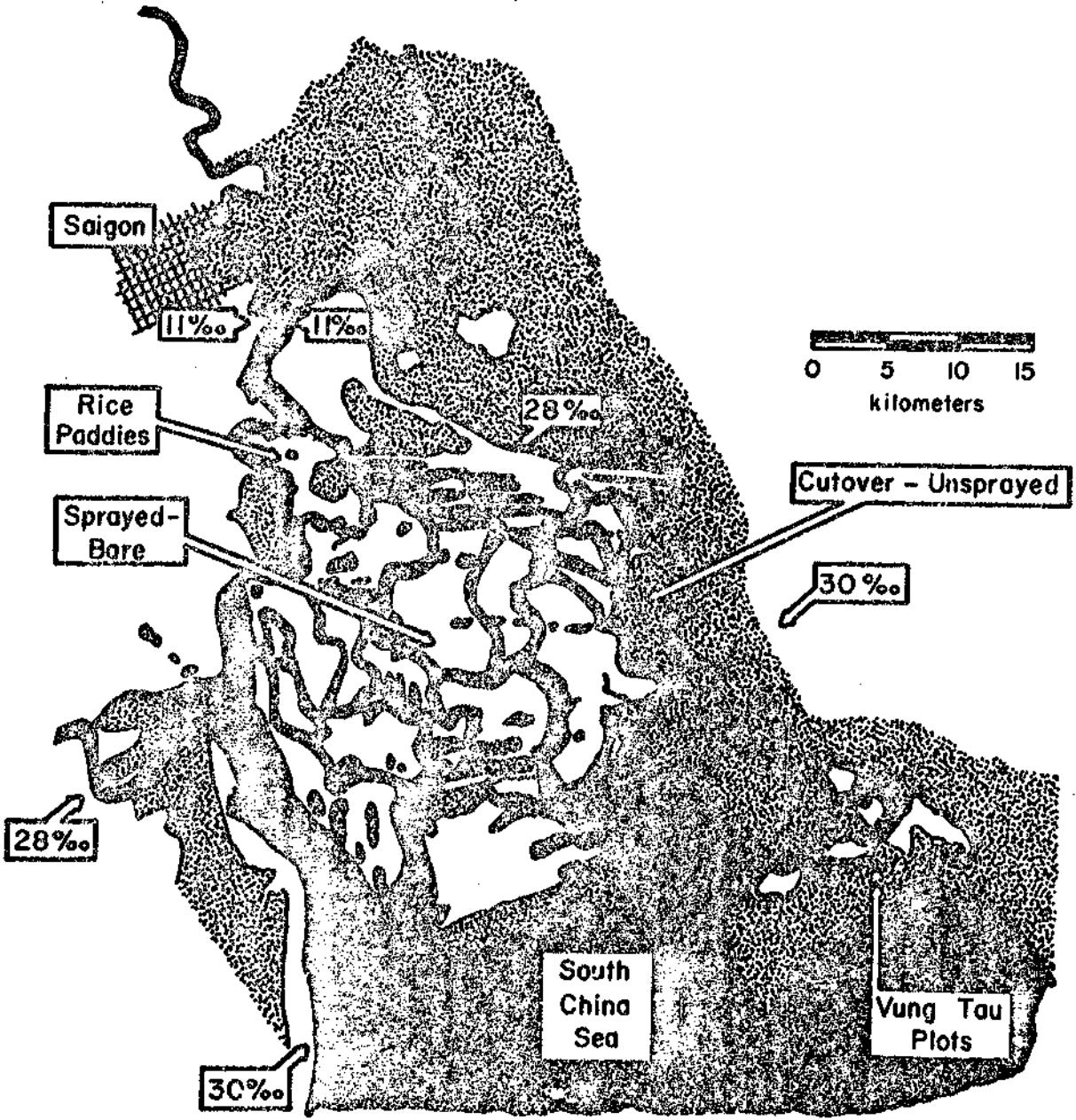

Figure 3

regrowth were microclimate, adequacy of seed source from remaining trees in the district, and adequacy of nutrients for plant growth. These are quantitative questions for which models may show perspective and simulations of the models show the ultimate consequences for various alternative factors. In the work of this contract mangrove models were developed and simulated with special attention to seed source, nutrients, and wood cutting of potential seed trees. Some field measurements were made in Viet Nam and in Florida to get data for the model. Sections 3, 4, and 5 concern these objectives.

3. Initial examination of the extent of herbicide action raised the question of the relative importance of country-wide herbicide actions to the normal processes and economy of the whole country and the relative importance of herbicide among other disruptive aspects of war such as bombs, military actions, plowing, guerilla activity, displacement of people, etc. If main relationships could be shown in a systems model, and if the correct orders of magnitude of energy flow could be assigned to these pathways, then these numbers would provide quantitative estimates of the relative role of herbicide action at the time of action. If approximate computer simulations were also done showing the time of disruption and recovery, these quantitative estimates could be extended to show the overall cumulative effects. The cumulative effect could be considered with and without financial stimulation to the energy recovery processes. The general effect of herbicide in defoliating upland vegetation and stimulating various recovery growths was to be considered in this way. Also a model of the whole country's response to war disruption was to be considered with an order-disorder-simulation in which the role of herbicide could be isolated. Sections 6, 7, and 8 concern these objectives.

4. Measurements were made by project personnel to get some numbers needed for models, to utilize comparative situations in Florida, and on one trip to Vung Tau in Viet Nam. Measurements were made of a herbicide treated mangrove experiment on Marco Island arranged by Howard Teas and these results are given in Section 3. Other data are included here in Table 1 - 3 on seedlings and forest floor characteristics. Phosphorus data in waters are given in Section 9.

5. A brief summary of the perspectives developed by the models, simulations, and model-based comparative calculations was prepared and worked over by subcommittees and then the general committee with the result given in Section 10. This was intended for the Part A to go to Congress. Unfortunately this was deleted by a second review committee who had never seen the detailed Part B.

Table 1

New Seedlings at Vung Tau in Cleared Plot; Transect 100m x 2m
W. Drew, 1972

Transect	Species	Number of Seedlings
1	<u>Avicennia</u> sp.	12
	<u>Ceriops</u> sp.	545
	<u>Rhizophora</u> sp.	23
	Others	29
2	<u>Avicennia</u> sp.	0
	<u>Ceriops</u> sp.	408
	<u>Rhizophora</u> sp.	56
	Others	58
3	<u>Avicennia</u> sp.	6
	<u>Ceriops</u> sp.	121
	<u>Rhizophora</u> sp.	63
	Others	1
4	<u>Avicennia</u> sp.	35
	<u>Ceriops</u> sp.	77
	<u>Rhizophora</u> sp.	98

Table 2

Counts of 0.5 m² Quadrats in Vung Tau Spray Sites, March 1972
(H. T. Odum, M. Newton, Neptune, Goss, A. Lang, & others)

Raw Data Quadrat	No. of Yellow & Green newly Fallen Leaves	No. of Black and Brown Leaves (Older)	Live Seedlings (In last Year)	Crabs Seen	Snails seen on Grnd. or Upper 6" of Stems	No. of Crab Holes Est.	Black Mangroves Pneumat- ophores
1	6	6	0	2	0	7	15
2	7	11	0	0	0	4	100
3	6	5	0	1	1	11	0
4	3	5	0	1	5	31	2
5	5	16	0	2	4	15	0
6	11	48	0	2	1	29	0
7	2	3	1	0	1	12	0
8	0	31	3	1	4	22	0
9	4	31	4	4	5	14	0
10	2	17	2	0	1	23	0
11	7	14	4	0	10	21	0
12	6	24	0	0	5	20	1
13	3	27	0	1	0	21	0
14	8	14	11	1	3	23	22
15	7	17	1	3	1	17	31
16	2	12	6	0	0	25	16
17	7	27	1	0	2	10	16
18	9	9	0	0	3	21	13
19	4	13	0	3	2	28	4
20	7	30	7	1	6	18	13
21	6	28	0	0	1	32	27
22	3	11	0	0	4	19	6
23	3	18	0	0	0	33	0
24	2	11	0	1	0	23	0
25	2	13	0	0	1	27	4
26	3	28	1	0	0	36	10
27	4	20	0	0	0	29	33
28	4	16	0	0	1	30	0
29	2	11	0	4	1	33	0
30	3	32	2	2	1	19	0
31	2	27	1	0	4	17	0
32	1	22	0	0	2	26	39
34	4	22	2	1	3	37	0
35	2	27	1	0	0	34	0
36	3	8	2	1	0	24	0
37	4	11	0	0	0	24	0
38	4	14	0	1	4	35	0
39	5	30	10	-	-	-	0
40	4	15	1	0	0	25	0
41	5	21	5	0	4	26	0
42	2	32	3	0	2	9	0
43	5	11	2	0	1	25	0
44	0	11	5	0	0	34	0

TABLE 3

Data on Seedlings Sampled from Rookery Bay on July 13, 1972

	Seedling Lengths, centimeters	Dry weight of Seedlings, grams
#1	27.6	9.1
#2	31.7	12.6
#3	24.4	7.0
#4	21.3	4.8
#5	25.6	7.7
#6	26.1	11.6

Seedling Counts of Rhizophora Mangle Along the Perimeter of Rookery Bay

Number of Seedlings m^{-2}	y_i^2	Overhang, feet	y_i^2
y_i	y_i^2	y_i	y_i^2
102	10,404	6	36
74	5,476	7	49
90	8,100	8	64
98	9,604	8	64
80	6,400	7	49
50	2,500	10	100
6	36	10	100
3	9	5	25
52	2,704	2.5	6.25
4	16	8	64
0	0	10	100
0	0	7	49
32	1,024	7	49
14	196	12	144
38	1,444	15	225
12	144	8	64
4	16	9	81
4	16	8	64
8	64	20	400
0	0	20	400
0	0	15	225
0	0	20	400
22	484	12	144
18	324	20	400
14	196		
0	0		
12	144		
0	0		
12	144		
34	1,156		
$y_1 = 783$	$y_1^2 = 50,601$	$y_1 = 252.5$	$y_1^2 = 3,302$

$y = 10.52 \text{ feet} = 3.2 \text{ meters}$
 $(y_1)^2 = 63,756$
 STD DEV = 6.4

$y = 26.1 \text{ m}^{-2}$
 STD DEV = 32.25 m^{-2}

Mangrove-Modelling Conference in Gainesville, June 1972
and Acknowledgements of Collaboration

The mangrove modelling workshop conference was held June 19-21 in Gainesville with travel funds (no honoraria) from the contract. Several of the participants were paid by their home organizations. Invitations went to those who were doing mangrove modelling or who were doing experiments or making measurements of key parameters needed in modelling such as reproduction, seedling germination, herbicide action, etc. We tried to draw representatives from each on-going mangrove research activity we knew about.

Each person attending took a half hour to input various data, results, ideas, questions bearing on the problems of herbicide and mangrove with the others participating in vigorous, probing discussion. In some ways this was like the main committee discussions except that in this group focus was on mangroves by people who were mangrove specialists.

Unfortunately, the marvelous reworking of ideas and concepts did not adequately feed back into the main committee as well as hoped because at the last moment Drs. Lang and Ross had to cancel. However, Teas and associates were there and Colley sent a representative. William Odum had been in on the original Moselson AAAS deliberations and was most helpful in integrating the mangrove-nutrition concepts. Gerald Walsh had potted mangroves under herbicide treatment in Pensacola (Gulf Breeze) and had special knowledge of mangrove plant physiology to draw from. Later he sent an extensive mangrove bibliography, which he forwarded to the committee office. Gilberto Cintrón of the Puerto Rico state conservation organization brought much knowledge of mangrove responses to disturbance and report of some spraying in Puerto Rico. One of the most active mangrove research projects is that of the Puerto Rico Nuclear Center in

relation to proposed nuclear plants and this work was discussed by Seppo Kolehminen (see below). Howard Teas and Joan Browder (later joining our contract work) from the Miami group discussed their seedling work and took the lead among the conference group in organizing a proposal to the main committee for a Florida test experiment to verify sensitivities and generate a focus for this group to augment the work of the main committee.

The conference in effect organized itself into a branch activity with a plan to the committee that would allow them to enlist some of their own organization's support in a common interest activity. Unfortunately, we failed to get enough enthusiasm from the main committee to do this as planned although after some delay in initial spraying was authorized, with Dr. Teas (rather than the conference group) providing most of the cost. In Section 9 are results of our measurements on the Marco Island plot which along with the main effort of Teas help established the sensitivity of American mangroves to "Agent Orange".

Linda Lefler contributed a review of mangrove physiology which she had done for Dr. Colley. Phil Miller flew in from Alaska and the discussions oriented him to the needs so that he could organize his work as our subcontractor for simulation work in San Diego done by James Ehrlinger. In this work Miller's work in simulating Florida mangroves on a Power Corporation project made his team ready to consider the microclimate limitations in sophistication on relatively small funds. W. Ziemann attended with W. Cdua and has since on his own done mangrove modelling receiving intellectual stimulus from the conference. It may be desirable for the committee to invite him to contribute whatever results and insights may have come from this. E. Kuenzler of NSF and E. Heald

could not come and several others of Miami Marine laboratory were not invited because we did not know they were involved. Armando de la Cruz at Mississippi State had worked in Philippines and gave us input later. J. Lincer was in Florida (Cape Haze) but we didn't know it then.

One of the most pertinent projects was the Fakahatchee slough project of S. Snedeker and A. Lugo of University of Florida on structure and function of mangroves in South Florida under support of Dept. of Interior. Progress report on this (written and oral) was made available giving critical numbers on biomass and seedlings. Later M. Sell did a special simulation on hurricane effects on mangroves with Lugo and Snedeker and this is appended as an appendix since it was partly an outcome of the conference communication. The surge of destruction by hurricanes is somewhat like that of herbicide, with great thickets of dead wood remaining and much kill that is not yet explained (broken stems? sedimented pneumatophores? stripped leaves?). The difference is that there was a scattering of Seed trees and there were no peasant wood cutters in south Florida and the wood has been standing for 10 years gradually decomposing as new growth comes from surviving trees. Dr. R. Goodrich of the Central and South Florida Flood Control District, West Palm Beach reported on his seedling restoration experiments on spoil islands in south Florida. One of his main points was that seedlings need to be planted in water depths and wave energy situations that are the normally suitable ones rather than general broadcasting of seedlings. Both Teas and Goodrich found low mortality rates with arial broadcasting of seedlings. Seedlings need not be weighted, for they will turn their new roots earthward in growth and do not have to be stuck into the mud. The consumption of roots of red mangroves in South Florida was described. Some regard it as possibly an adaptive regulator of horizontal extent of mangroves. Questions were

raised about nitrogen fixation in mangrove muds and Teas proposed work by them on this. Both Teas and Goodrich felt that the topography (or immediate environment) of the place the seedlings landed was the most important factor in seedling survival. Mangrove could grow where there was an accruing shore line (low energy), and available moisture (elevation). Contributing to the discussions and plans were many staff and students of the Environmental Engineering at the University of Florida.

J. Ewel aided the work in many ways especially in his plans and discussions at the first meeting of the herbicide committee in Washington. He proposed the use of the Holderidge approach to the uplands--later the subject of Bethel's proposal. Frank Nordlie participated from Zoology. Joan Browder supplied an 8-page review: "The Role of Birds in Mangroves" with 10 references and special reference to Cattle Egrets and this was forwarded to F. Golley for the animal write-up. Knipling attended from the Department of Agriculture providing maps and liaison with the work by Weatherspoon.

In the year that followed the conference, varied mangrove studies continued among those who attended the conference. Gerald Walsh published a note on herbicide studies on seedlings. Stimulated by the conference, J. Zieman and W. E. Odum (University of Virginia) have separately and on other funds developed some mangrove models to be reported at forthcoming scientific meetings. In the year that followed the conference, under Department of Interior funds related to the Fakahatchee strand in south Florida, S. Snedaker, A. Lugo, L. Burns and others made extensive measurements and some further modelling of the Florida mangrove swamps.

Following one of the herbicide conference meetings, H. T. Odum and P. Zinke of University of California visited the Marco Island herbicide site, collecting samples that were analysed along with Viet Nam samples by Zinke.

Included were some samples from the Snedaker-Lugo project sent to him at that time. In July of 1973 another Mangrove conference was held under auspices of the Conservation Foundation with Department of Interior funds at St. Petersburg coordinated by S. Snedaker. This conference was not definitely related to the herbicide work but parts of those at the other conference continued their research communication concerned with mangrove health and reforestation.

The following note was received from Puerto Rico participants:

ENVIRONMENTAL CHANGES AND RESEEDING OF A
KILLED MANGROVE AREA IN PUERTO RICO*

by G. Cintron** and S. Kolehmainen

In Puerto Rico there is a mangrove area, a few acres in size, that was killed by human activities, probably with a herbicide. This area is on the north coast of the island in the estuary of Rio Grande River. The mangroves have been dead over a year, and consequently, similar factors as in the Rung Sat area in Viet Nam have been affecting the sediments for an extended period. Therefore, it is felt that this area in Puerto Rico can be used to study the possible changes in the environmental conditions of water and sediments that could have happened in Rung Sat. A healthy mangrove area may be used as a control area.

The herbicide sprayed areas of mangroves have been barren for two to seven years. During this time the soil and the sediments have been exposed to sunlight, tides and rainfall. This means that the oxidation rate of organic matter must have increased due to the higher temperature, lessened input of organic matter and increased flushing rates of tidal and runoff water. When the foliage of mangroves were destroyed, the increase in the light intensity increased greatly. This, in turn, probably increased the production of benthic algae.

ORDER-DISORDER, MANGROVES, HERBICIDE, AND WAR

Ecological Modelling for Evaluating Disruption and Recovery

Large scale systems of man and nature such as forests, mangrove districts, agricultural country sides and urban areas have regular and normal process of construction, replacement, and reconstruction that tend to maintain ecosystems, human settlements, trees, soils, leafy matter, houses, streets, riverbeds, wildlife, social organization, etc. Working against these constructive processes are the natural tendencies for all structures and information to deteriorate with time as required by the second law of thermodynamics. In addition there are frictional and accidental losses that occur as part of constructive efforts and that form special disruptive processes such as earthquakes, hurricane, and war. The action of herbicide is a special disordering action.

To gain perspective on the importance of a disruptive process, one may estimate the magnitudes of direct and indirect energy involved to find what percentage its effects have been of the total energy budget of the whole system. One may compare herbicide action in energy measures with that of the whole system but with the aid of a model to consider main actions, interdependencies, feedbacks, self regulatory actions, times of action, and time of recovery of the system to former state. Systems methods relate parts to wholes and thus are helpful for impact studies. Here, we use four systems methods to gain perspective on the relative action of herbicide in relation to the war disruption as a whole and the role herbicide played in the general process of South Viet Nam as a whole, 1965 and after. The four methods used were the following:

1. Systems were diagrammed to show interactions believed important.
2. Energy flows were estimated for comparison in diagrams and tables to evaluate importance of the pathways.

3. Computer models were simulated to show consequences in time that disruptions produced in models. The simulations were used to test whether concepts for the manner of action of disruptions such as herbicide produce the patterns observed in the real situation.
4. Models were tested to generate forecasts, determine what future actions might be considered, and test the consequences of proposed measures.

Models and simulations were made on two scales of size as follows:

1. The Rung Sat mangrove district, the largest mangrove area defoliated, was studied with emphasis on biomass, productivity, land coverage, and reproduction of the mangroves. The models included disruption and recovery, factors of herbicide, seeding, cutting, nutrient, and mud temperature.
2. An overall view of Viet Nam was modelled to determine the effect of herbicide on the maintenance of organized structure. Evaluations and simulations included disruption by war and herbicide, the recovery feedback stimulation from the disruption, the energies and monies of order and disorder from nature, from communist sources, and from the U.S.

Steady States and the Balance of Ordering and Disordering

Any system that sustains continuous life in the long run must develop a balance of its ordering and disordering processes. We visualize these as circular relationships as in Fig. 4. Such circular systems tend to return to a balance after disruption. A system in such a balanced state is said to be in steady state. Surviving systems develop an ability to repair and accelerate restoration and recovery when disrupted by recycling materials and energy from its storages combining these with new potential energies to stimulate reconstruction of the disrupted zone. We are all familiar with these processes in a forest where new trees accelerate growth to fill a spot where a tree fell. Fertilizer nutrients from fallen and disrupted trees are released and recycled by the animals, micro-organisms, and root actions, stimulating regrowth. Pathways of supply of energy resource of sun, rain, and geological substrate are free to be harnessed again.

Similar processes stimulate recovery on the larger scale of whole countries. Parts and fragments of the disordered state stimulate regrowth provided there is available abundant energy sources or sources of money to purchase the energy resources. For example, disrupted land, displaced people, disordered materials and released nutrients tend to stimulate reconstruction activity.

Summarizing the concept of self-maintaining systems we find there is a symbiotic balance between ordering and disordering process in the normal system with cycles of disordered materials back to reuse in new construction. When there is a surge of disruption, there is a surge of stimulation by land, people, and materials in symbiotic action that accelerates the reconstruction somewhat later (if there is an energy source). Any ultimate judgment of the effect of a process must consider the short term, and long term effects.

Some actions of war are short pulses that have immediate surges to disorder followed by resurges to the reordering process. Where actions of war or other disturbances are chronic and continuous, the effect of the disruption being more continuous causes a more continuous drain from the resources so that a new steady state balance is achieved, one with more disorder on the average. We can call this a stressed steady state. In some ways the protracted period of wars in Viet Nam has been a stressed steady state, although there have been surges within it with intensive periods of herbicide actions, bombs, military actions, etc.

Given in the systems diagram in Fig. 4a is the simple idea of the constructive actions contributing to structure of man and nature over the countryside, balancing the destructive actions of nature and man. Notice the pathway by which increases in disordered areas and components stimulate the regrowth. Herbicide is one of the special disruptive stresses (Fig. 4b).

The systems diagrams of pathways of action and storage are also pictorial

Fig. 1. Cycle of Order and Disorder

(a) Concept

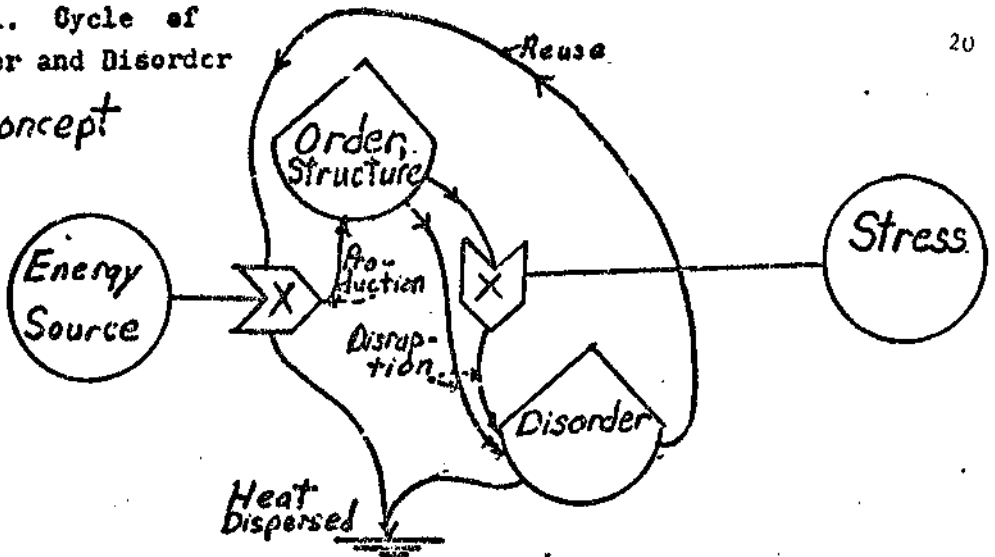

(b) Viet Nam

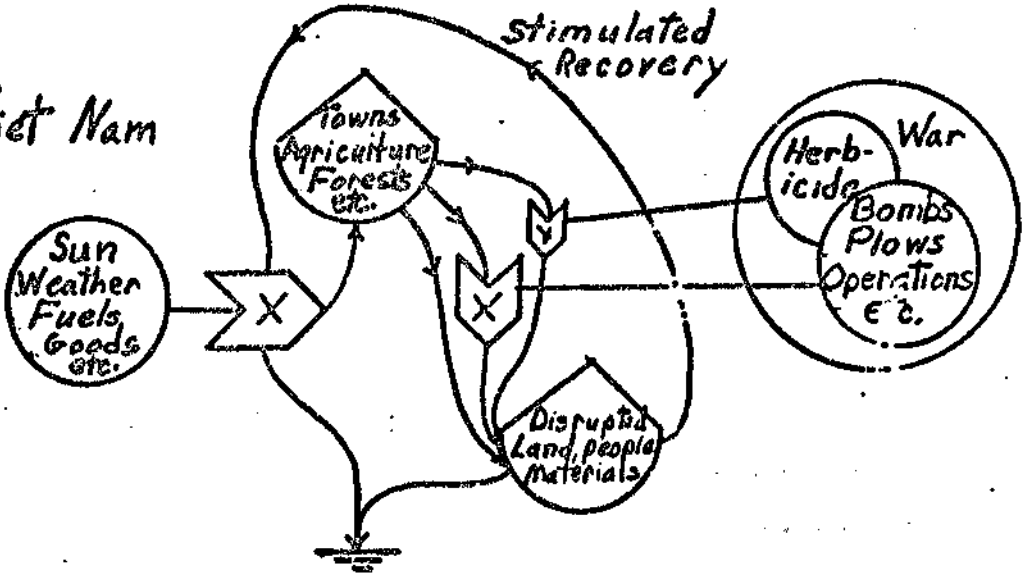

(c) Mathematics

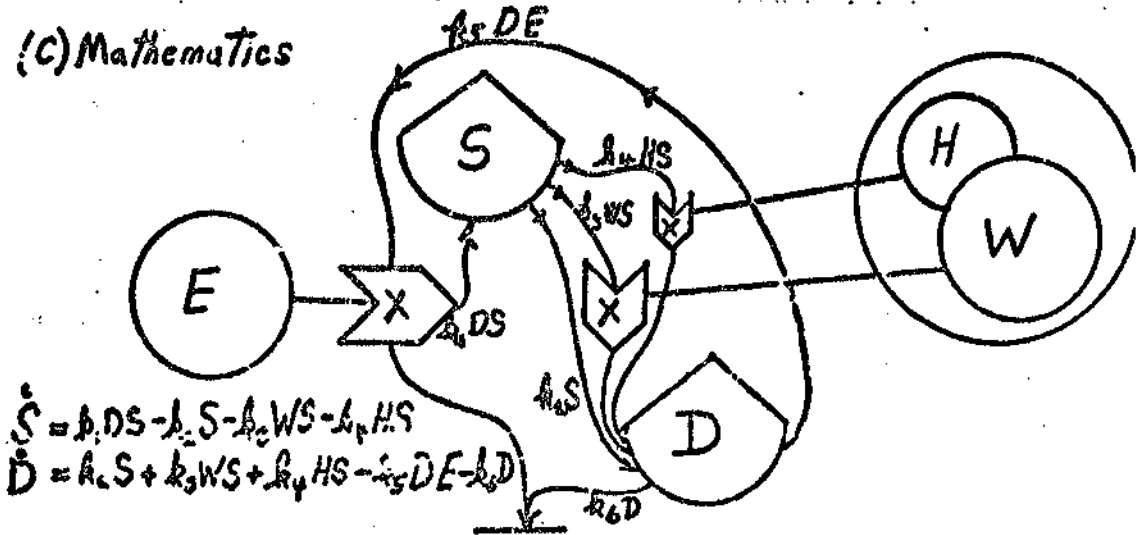

$$\dot{S} = k_1 DS - k_2 S - k_3 WS - k_4 HS$$

$$\dot{D} = k_5 S + k_6 WS + k_7 HS - k_8 DE - k_9 D$$

ways of representing mathematical equations that are another way of indicating an ecological model. For example, the equations that go with Fig. 4b are shown in Fig. 4c to help the readers understand the connection between the diagrams and mathematical statements. Each mathematical term refers to one pathway and the several equations together summarize the systems diagram. For each pathway, there is coefficient (k) which indicates how much flow there is in that pathway per unit of driving action coming from upstream storage unit or units.

In computer simulation, the mathematical equations are allowed to interact together and continuously so that the various inflows, interactions, stresses, etc. take place with the complexity shown in the diagrams and as a result, graphs are plotted that show the rise and fall of various properties of the system with time for comparison with those observed in the real world or as a prediction of possible future action.

The systems diagrams show the various kinds of important storages (tank symbol, Fig. 1) of a system (such as structure, disordered parts) and the pathway lines show where one flows into another or where one interaction acts on another in a stimulatory control action (workgate, Fig. 1d). Many control actions at workgates are amplifying, multiplicative (indicated by pointed block with multiplier sign X , example, Fig. 1). The ultimate sources of actions in the system are the energy sources outside such as the sun's energy or the source of support to armies or the fuel energies brought in by tanker (Circles, Fig. 1c).

The diagrams may also be used to show relative magnitudes of actions and storages by writing in the numbers for storage in the tanks or numbers for flows on the pathways. (See, for example, Section 3, Fig. 3. In that model data are used to evaluate coefficients of the mathematical equations and analog and digital computer simulations are given. For others, we use

descriptive energy diagrams to show perspectives on the role of herbicide in mangroves and in the war and Vietnam as a whole. More details on symbols and procedures are given in a recent book (Odum, 1971, Environment, Power, and Society, John Wiley).

Analog Simulation of Order-Disorder Model

Given in Fig. 4d is the result of a simulation of the order-disorder model which verifies the general stability of the provision for the symbiotic balance and recycle between order and disordering tendencies. In the first graph the levels of order and disorder are immediately established, these being somewhat different from the initial conditions first established. Thus Q_1 rises to a level as Q_2 disorder falls to a lower level.

In the second simulation a disordering stress is applied that pumps order into disorder, a relatively easy process since it goes in the direction of the normal degradation that ultimately accompanies any storage of order. While this disordering stress is operating, the levels of order and disorder shift to a new leveling that is equally stable. Turning up the disordering action pulls order down so that it is in short supply and the rate of disordering is diminished for lack of further structure to disorder. Disorder becomes so abundant that it stimulates rapid recycling recovery as long as there is a regular unlimited energy source to be tapped. Diminishing order beyond its point of scarcity becomes difficult. With removal of the special stress, the system returns to its original levels of order and disorder.

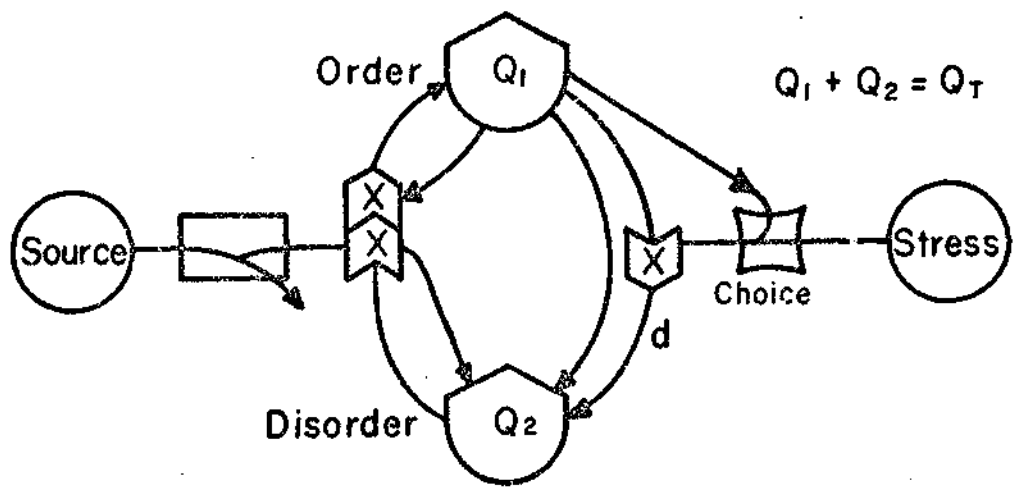

Without Stress

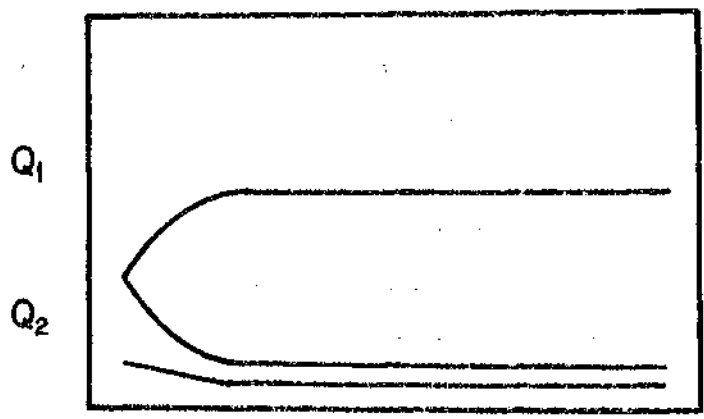

With Stress

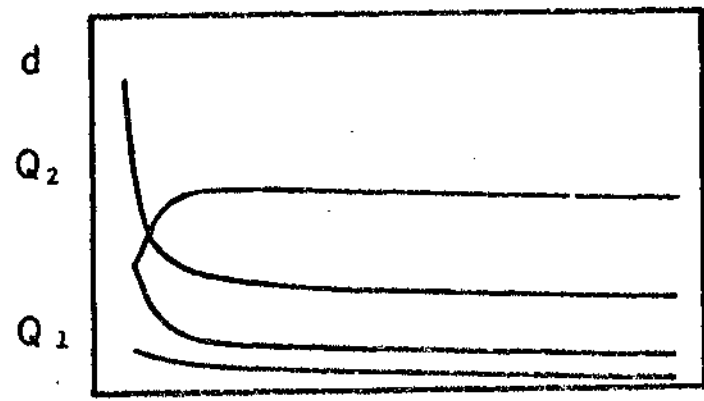

Figure 4d

Models of War and Stress

Because we use simplified war models in relating herbicide to overall energy budget, we give here some background on war models.

We have not made an exhaustive review of political modeling or those with war, but those earlier efforts many help set our Viet Nam simulations in perspective.

Through the aid of Gary Murfin we located a simulation of the Viet Nam conflict by J. S. Milstein and W. C. Mitchell (1968) and one by John Voevodsky (1968).

Milsum (1968) building on Richardson's armament model (1960) has the competition between nations as summarized in our diagramming of their equations. Since these models fail to put in an energy constraint and do not have the environmental interaction, they may not be very real or pertinent.

Odum (1971) has two models of war interaction that include energies and losses with distance with both offensive and defensive war (Figures 5 and 6).

Saaty (1972) proposed a model which M. Sell diagrammed and put on analog simulation as given in Figures 7 and 8. It has the feature of each controlling the other's energy input and one pathway of inhibition. None of these have the environmental impact.

Figure 5 WAR Models (Odum, 1971)

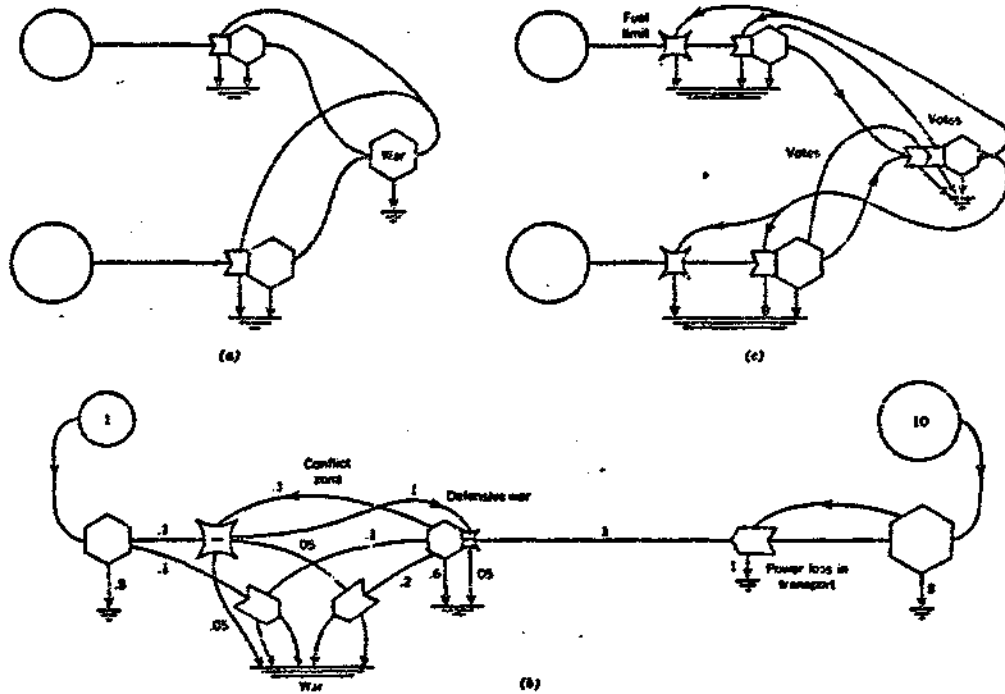

Regulatory organization systems which provide coexistence. (a) Summarizing diagram for war as a consumer drawing more power from the larger unit. (b) Details of war system of power regulation with conflict zone closer to smaller unit. (c) A governmental organizational system with votes proportional to power but power flows regulated to equalize standards of living and limit growth while preventing competition.

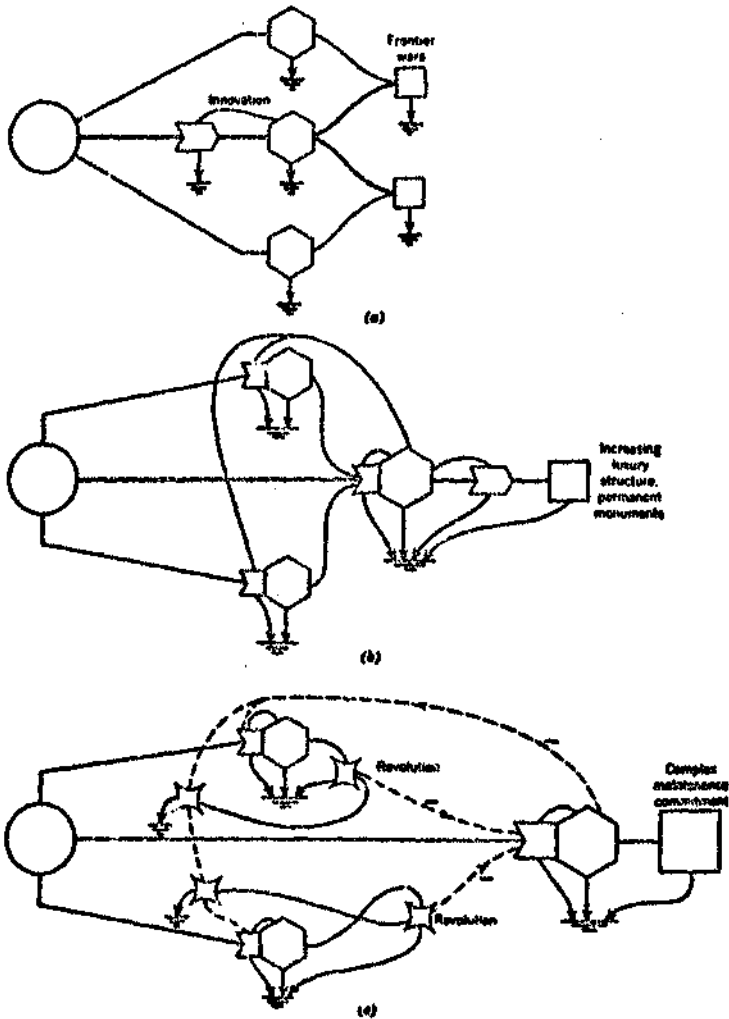

Energy diagrams representing three stages of history suggested by theory of Toynbee: (a) period of excess power; (b) period of constant power; (c) period of eroded power. Dashed lines indicate pathways which are lost.

Figure 6 War Models (Odum 1971)

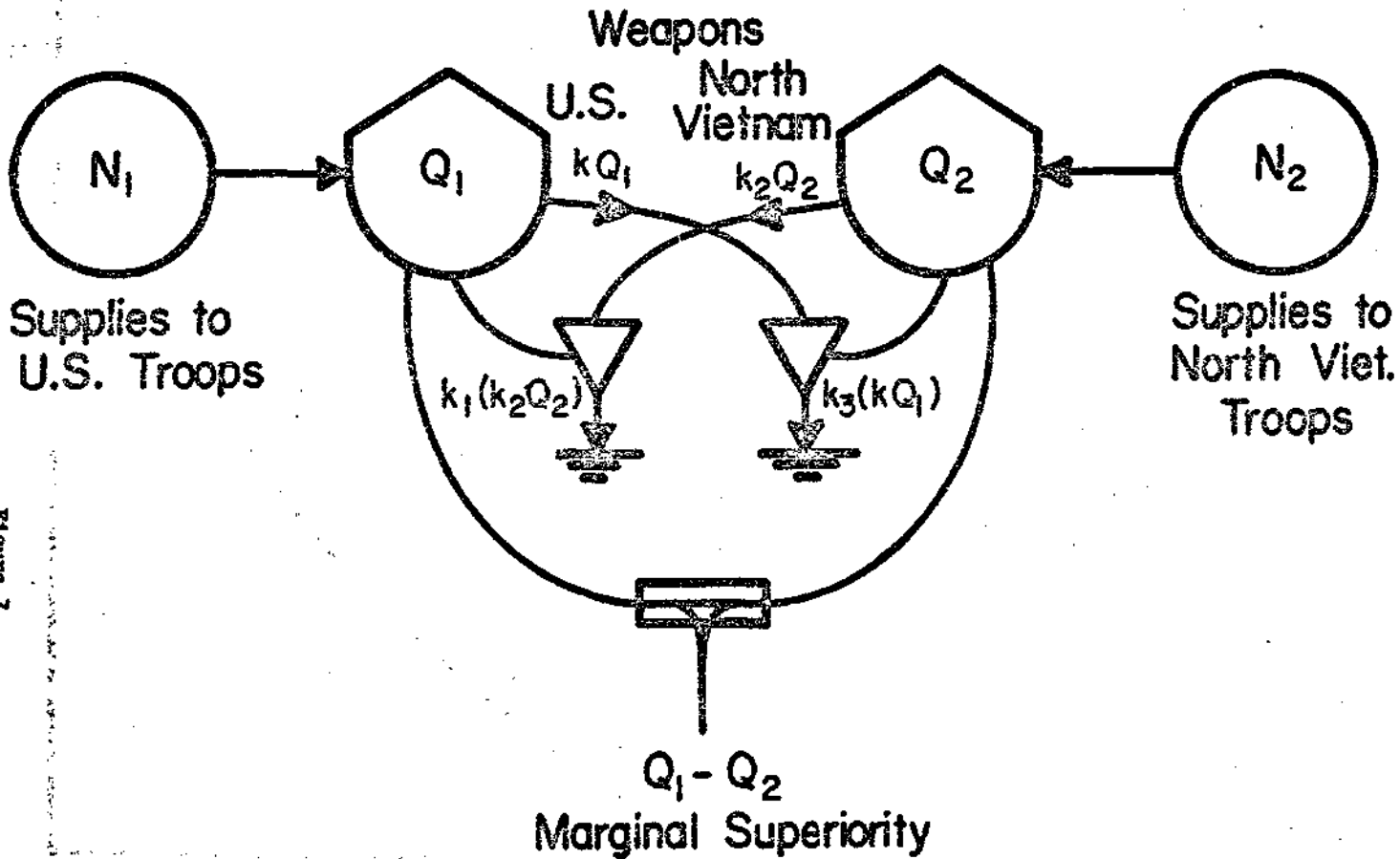

Figure 7

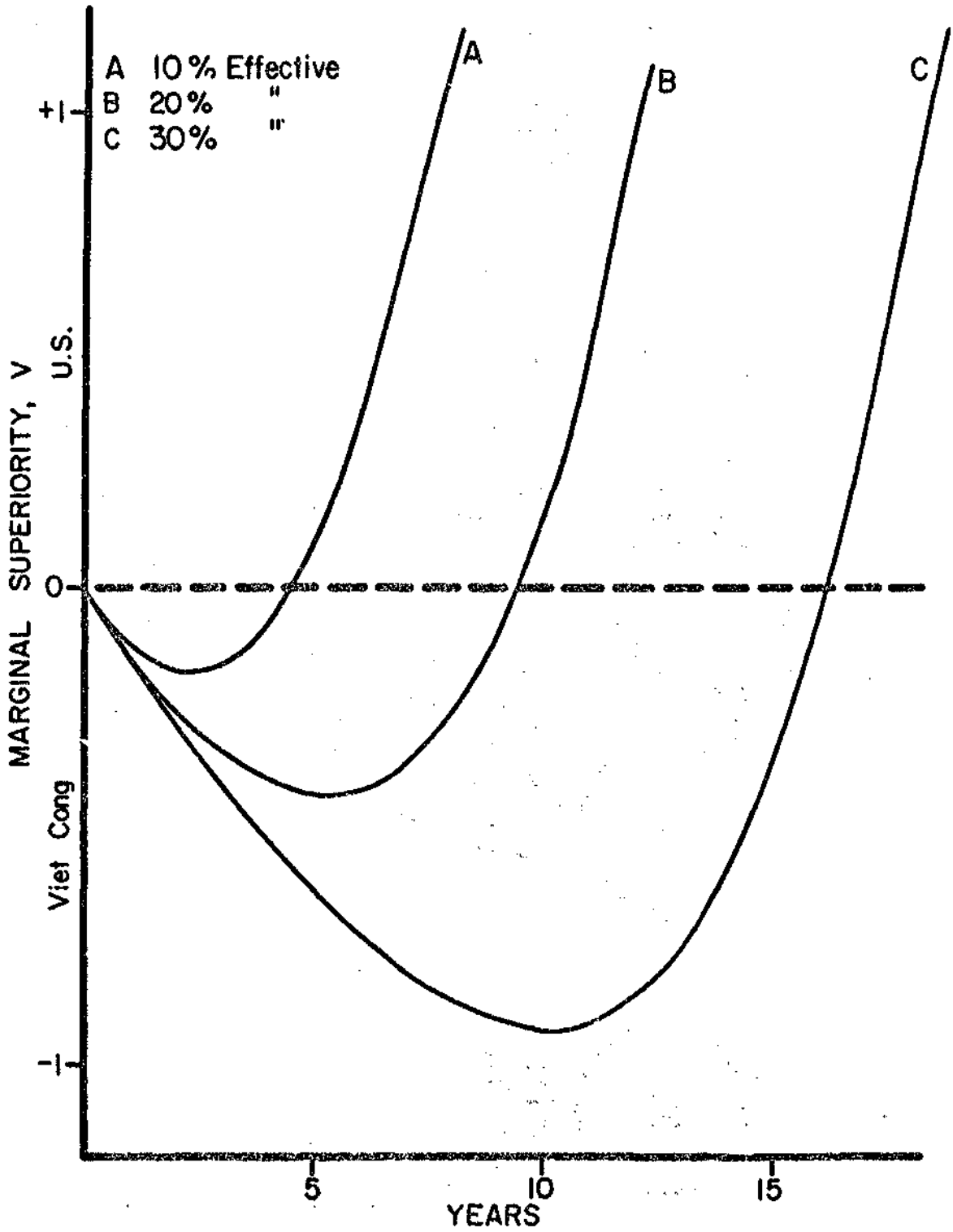

Figure 8.

Milstein and Mitchell tested the models for the stimulation of one sides warring activity by the other with such parameters as troops killed, indices of negotiation initiatives, indices of confidence, etc. and economic support. Good fit was obtained to the intensity of war as it varied month to month in terms of the interplay of military decisions. The model did not have an energy constraint and may have succeeded at its predictions because neither side was really energy limited except through its own decisions as to what resources to commit, based on decisions of the other environmental impact was not involved.

Christine Paddock working in our group last year (unpublished manuscript) simulated the course of oscillating war and peace in the primitive tribe based on 4 criteria of decision related to resources, especially pig crop. The simulation was quite like that qualitatively documented by Rappaport (1971).

Voevodsky (1968) has a model for war as dependent on some exponential declining storage whose time constant and initial conditions of resource ultimately determine the end of the war. This single decay tank is a little like the pigs for the ancestors pig accumulation theory.

Stress Amplifier War Interaction
Maurice Sell

In addition to the models of war and stress developed by Zucchetto and Swallows and Brown for this report to the committee studying the effects of herbicide on South Vietnam, other models have also appeared in the literature. One such model was discussed briefly by Saaty (1972) as an example of game theory.

Saaty considers three variables in his discussion: the United States supply of vital weapons, Q_1 , the supply of weapons for North Vietnam, Q_2 , and the accumulated marginal superiority of either of the two warring nations, V . Each nation according to Saaty has a choice as to the fraction devoted to depleting the reserves of the enemy. That nation able to accumulate resources would be the victor.

In Saaty's model, the accumulation or loss of U.S. weapons with time depends on the rate at which weapons are obtained from outside sources, N_1 and the rate of depletion by North Vietnamese forces, $k_1 k_2 Q_2$. In equation form this becomes

$$\dot{Q}_1 = N_1 - k_1 k_2 Q_2 \quad (1)$$

$$0 \leq k_2 \leq 1$$

where k_1 is a measure of North Vietnam's effectiveness against the United States and $k_2 Q_2$ represents the weapons used by North Vietnam for the purpose of attrition. A similar equation for the accumulation or loss of weapons by North Vietnam is

$$\dot{Q}_2 = N_2 - k_3 k_4 Q_1 \quad (2)$$

$$0 \leq k_4 \leq 1$$

One of the two nations in conflict may ultimately be more successful than the other and will accumulate marginal superiority according to the equation

$$\dot{V} = (1 - k_2)Q_2 - (1 - k_4)Q_1 \quad (3)$$

where $1 - k_2$ and $1 - k_4$ are the fractions of North Vietnamese and U.S. forces, attacking each other.

Saaty then proceeds to determine optimal strategies for each side and concludes that as the war ends both sides are spending all their resources attacking each other rather than trying to deplete the reserves of the other nation. If it is assumed that the North Vietnamese are less effective than the U.S. in depleting reserves, then Saaty concludes that North Vietnam switches to full attack some time before the end of the war and this equals the reciprocal of the effectiveness of North Vietnam. In other words the less effective North Vietnam is with attrition, the faster they switch to full attack.

Since Saaty presented no data or curves to support this model, a simplified model was drawn using the equations developed by Saaty. This model is shown as Figure 7. In this simulation that follows no data were used so that the results are entirely qualitative. Also, the model does not include conditions for switching more reserves to attack or attrition, whichever is needed. Intelligence reports would also have an effect on the fraction used for attack and attrition of the enemy.

Figure 8 shows the accumulation of marginal superiority as it varies with time for the following conditions:

1. North Vietnam is at 80% full strength and 50% of this goes to attrition of U.S. resources with 50% effectiveness.
2. The United States is at 50% full strength and 50% of this goes to attrition of North Vietnam's resources with varying rates of effectiveness. Supply rates are the same for each nation.

In Curve A the North Vietnamese are only 10% effective in depleting U.S. resources and develop very little superiority. Within 5 years the U.S. begins to develop superiority and continues to increase its superiority. At 25% effectiveness the U.S. begins to become superior after about 9 years and at 30% effectiveness it takes about 16 years. A curve not shown indicates that if the North Vietnamese are 50% effective, they maintain superiority. As one side begins to lose the war, it seems that the rate of supply of resources would be increased. This was not considered here and is indeed a shortcoming of the model. However, this paper was not intended to fully detail the Vietnam war but only to indicate trends. As mentioned previously, a vital element missing is the adjustment one or both conflicting nations would make to keep the other from becoming superior militarily.

References

1. Milstein, J.S. and W.C. Mitchell, "Dynamics of the Vietnam Conflict: A Quantitative Analysis and Predictive Computer Simulation," Papers, Peace Research Society(International), 10 pp. 163-213 (1968)
2. Milsum, J.H., Positive Feedback: A General Systems Approach to Positive/Negative Feedback and Mutual Causality, Pergamon Press 1968
3. Rappaport, R.A., "The Flow of Energy in an Agricultural Society," Scientific American, 224, No. 3, 116-133 (1971)
4. Richardson, L.F., Arms and Insecurity Stevens and Sons, London 1960
5. Saaty, T.L., "Operations Research: Some Contributions to Mathematics," Science 178, 1061-1070 (1972)
6. Voevodsky, J., "Quantitative Behavior of Warring Nations"(Source unknown) 1968

3. Model of Mangrove Productivity, Herbicide Spraying,
Wood Cutting and Seedling Availability in the Rung
Sat Zone of South Vietnam

Maurice G. Sell, Jr.

Probably the most important, economically, of all the mangrove species found in the Rung Sat are those belonging to the genus Rhizophora. The species, Rhizophora mucronata, is very prevalent in the Rung Sat and has economic value as charcoal (Van Cuong, 1964). Since this species comprises about 75% of the mangroves, the data compiled for the simulations relate exclusively to Rhizophora spp. For the purpose of orientation a map of the Rung Sat is shown in Figure 1.

An important concept used in simulating the mangrove community of the Rung Sat was that of being able to omit many of the detailed occurrences in the mangroves. For example, the process of photosynthesis produces organic matter used by the mangroves for growth and metabolic processes. The actual process of photosynthesis includes many steps or chemical reactions that eventually result in the production of organic matter. This detail was not needed in this model since the primary concern of this study involved events on a larger scale. This technique of lumping is probably valid whenever the overall result of some process is desired rather than the intricate details.

A simplified model of the mangrove forest in the Rung Sat is shown in Figure 2 using the symbols previously described in Fig. 2, Section 1. This model has several parameters operating on the mangrove forest as outside forcing functions (circular symbols). The state variables (tank-shaped symbols) are those variables whose levels were thought to be important in this model. Each line represents a pathway that connects state variables with each other or with one or more of the outside forcing functions.

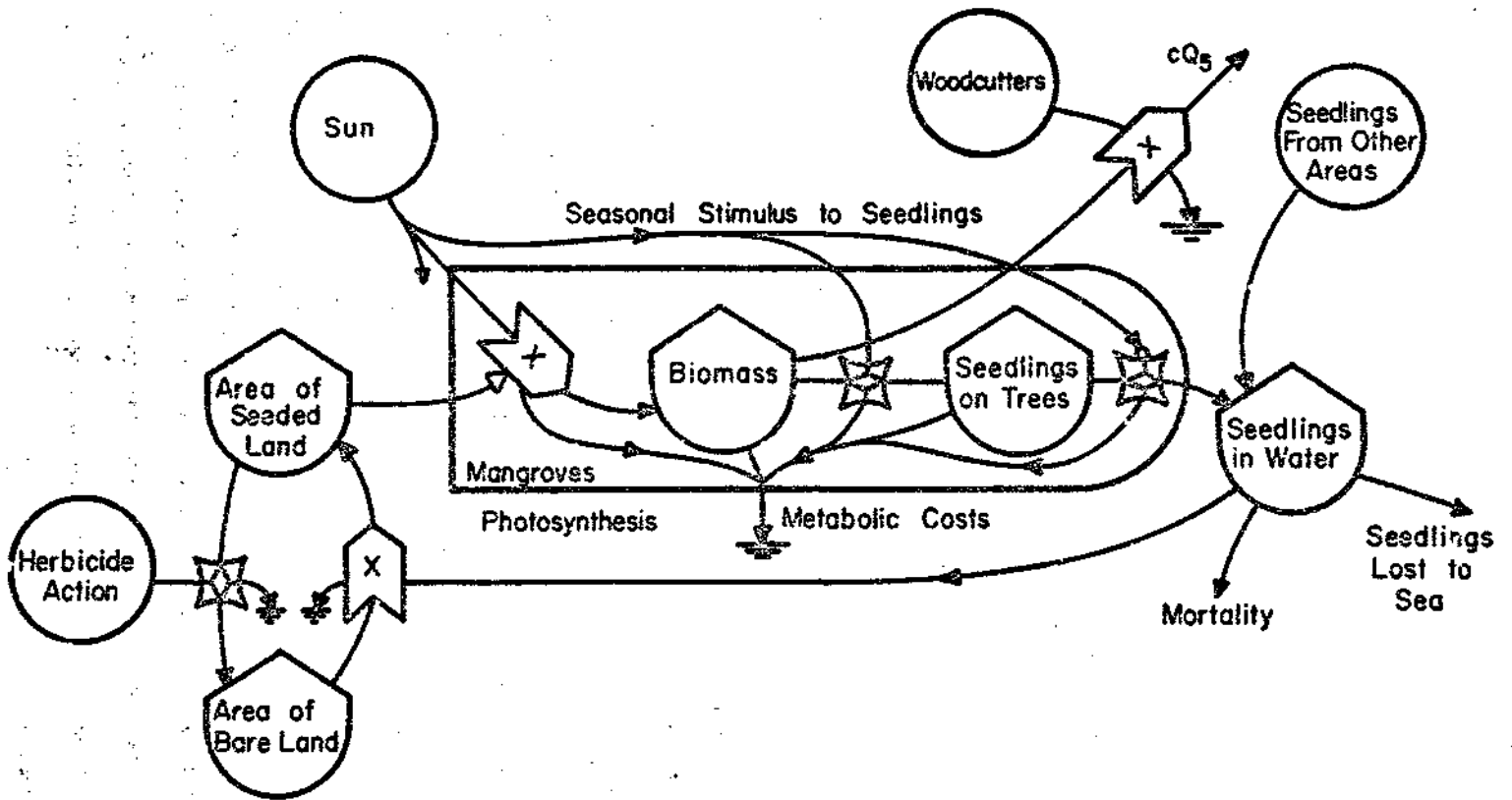
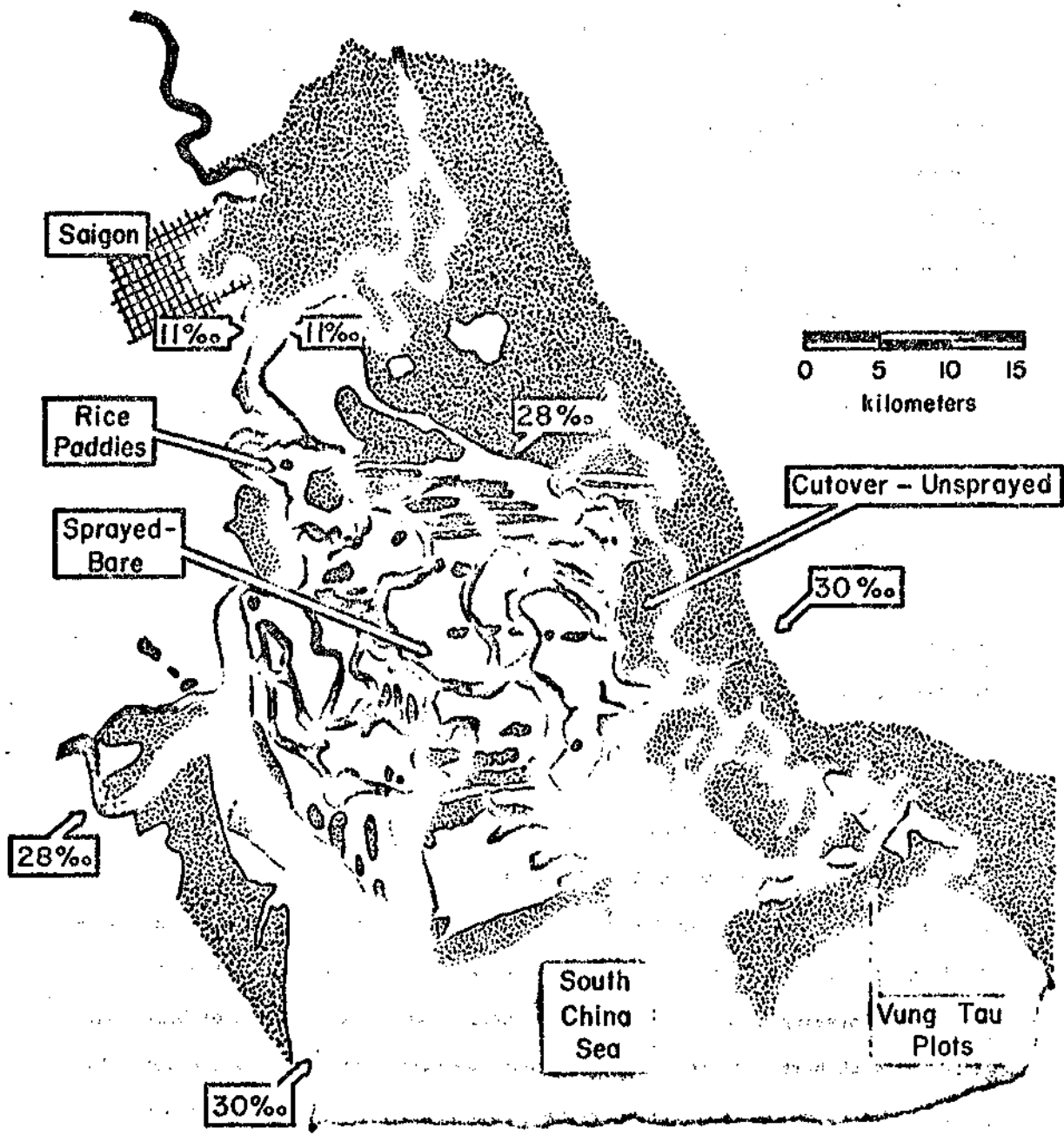

Figure 2



The sun is shown as a forcing function that interacts with the amount of land covered by the mangrove trees. In this model the amount of solar energy available to the mangroves is taken as 50% of the incoming solar energy. The flow from the sun-land interaction is going to be called gross photosynthesis. In reality the value of this pathway probably lies somewhere between the upper value of gross photosynthesis and the lower value of net photosynthesis. Since net photosynthesis carries a different meaning for each individual, let it suffice to say that the pathway is slightly less than gross photosynthesis. This pathway of organic matter flows into mangrove biomass and increases as more land is covered by mangroves. The organic matter produced through the sun-land interaction is used by the mangroves for growth and metabolic activities. Woodcutters are very important in their influence on the mangrove forest. They are shown cutting wood at a rate proportional to the level of mangrove biomass. The production of seedlings is shown as a seasonal occurrence. In May of each year the mature mangrove trees begin to use some of the organic matter to grow seedlings which continue to grow until about October when seedlings begin to fall from the trees. The fall of seedlings was assumed to occur during a period of sixty days (Gill and Tomlinson, 1971). The number of seedlings hanging from mangrove trees was included as a state variable. When these seedlings drop from the trees, many of them remain beneath the parent tree, but actual numbers were not available. This should depend on the effectiveness of tidal flushing. Some of the seedlings are carried by tidal or river currents to other areas. These seedlings are shown as a state variable labelled seedlings in the water. Some of these seedlings may eventually colonize an area devoid of mangroves. This colonization is shown as an interaction between seedlings in the water and bare land to give land that is covered by mangroves. In the Republic of Vietnam extensive spraying with herbicide has brought about vast areas of bare land. Spraying with herbicide is shown as an outside stress draining land covered by mangroves to eventually cause bare land resulting from death of the mangroves.

through spraying and removal of the trees by the woodcutters. A pathway has also been included that represents the planting of mangroves by man if this is a desired course for Vietnam to follow.

Figure 3 shows the values used for the state variables and pathways in the model. These numbers represent the total size of the variables or flows in the Rung Sat. The numbers for the simulations were obtained primarily from mangrove research studies in Puerto Rico or Florida. Solar radiation data and land and water areas were obtained for the Rung Sat.

Data Used in Model Calibration

Solar Radiation

Data for solar radiation at Saigon for the period January 1964 through October 1967 were used to derive a curve that approximates the data. The data were supplied by the United States Department of Commerce, Weather Bureau. Values are given in Table 1 in units of $\text{kcal m}^{-2} \text{ day}^{-1}$ on a monthly averaged basis. These values are also plotted in Figure 4 where it can be seen that the curve is approximately sinusoidal. For the simulation a sine wave was used.

Level of Mangrove Biomass

Biomass values were unavailable for the mangrove forests in South Vietnam so a value was chosen from the literature for mangrove forests of similar stature. The biomass of mangroves in Puerto Rico was measured by Golley *et al* (1962) as 5000 grams per square meter (1000 grams per square meter is equivalent to 4.5 tons per acre) in leaves and wood. This was used as the initial condition value for mangrove biomass in the Rung Sat model. Rates of gross photosynthesis and respiration were also from the Puerto Rico study. Cutting rate was estimated as 3% of the mangrove trees per year.

Figure 3

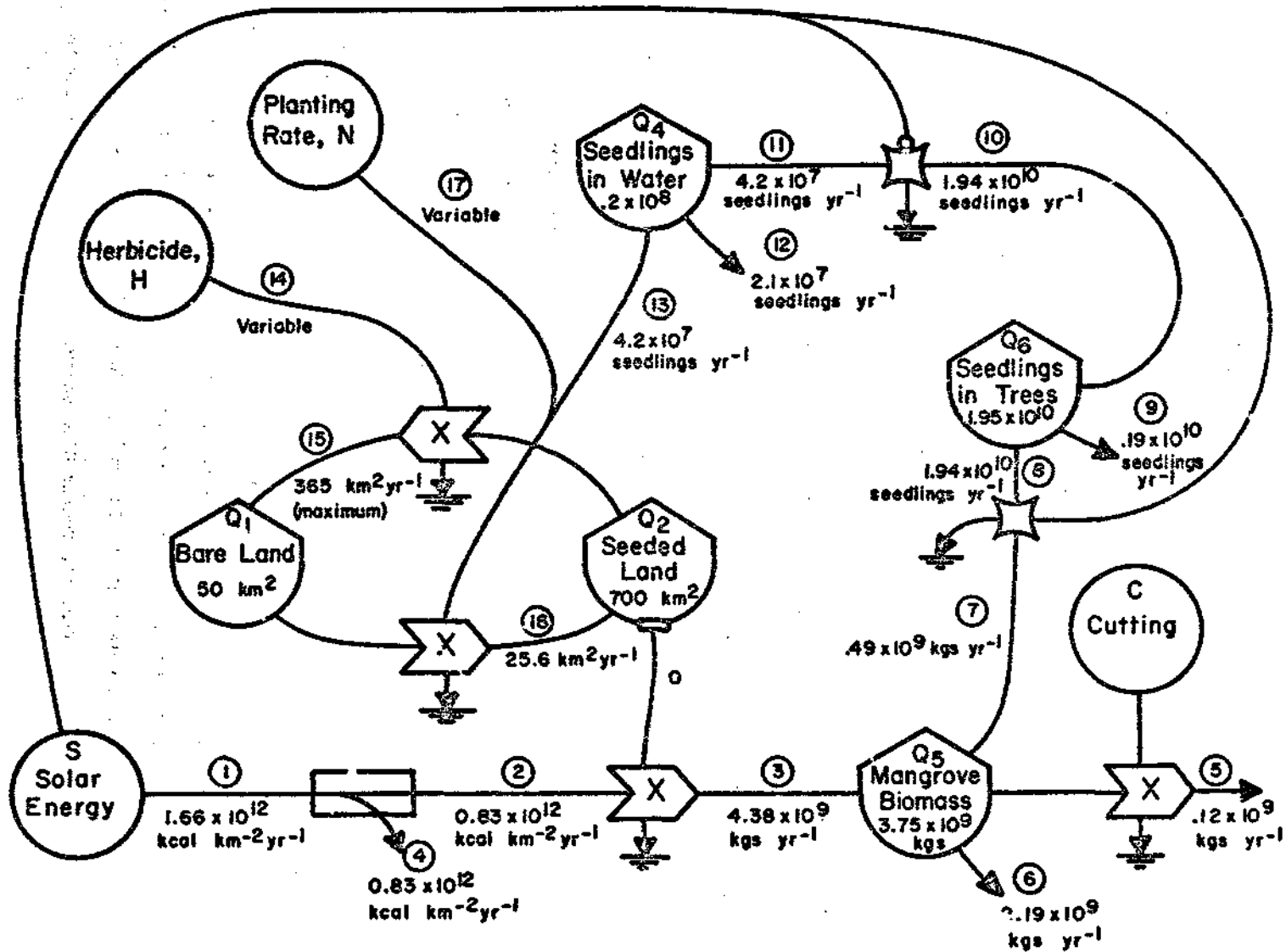

TABLE 1

Monthly Solar Radiation Data for Saigon From January 1964 to October
1967 (Units of kcal m⁻² day⁻¹)

<u>Month</u>	<u>Solar Radiation</u> (kcal m ⁻² day ⁻¹)
January	3500
February	4220
March	4560
April	4380
May	3680
June	3910
July	3860
August	3690
September	3560
October	3350
November	3160
December	3160

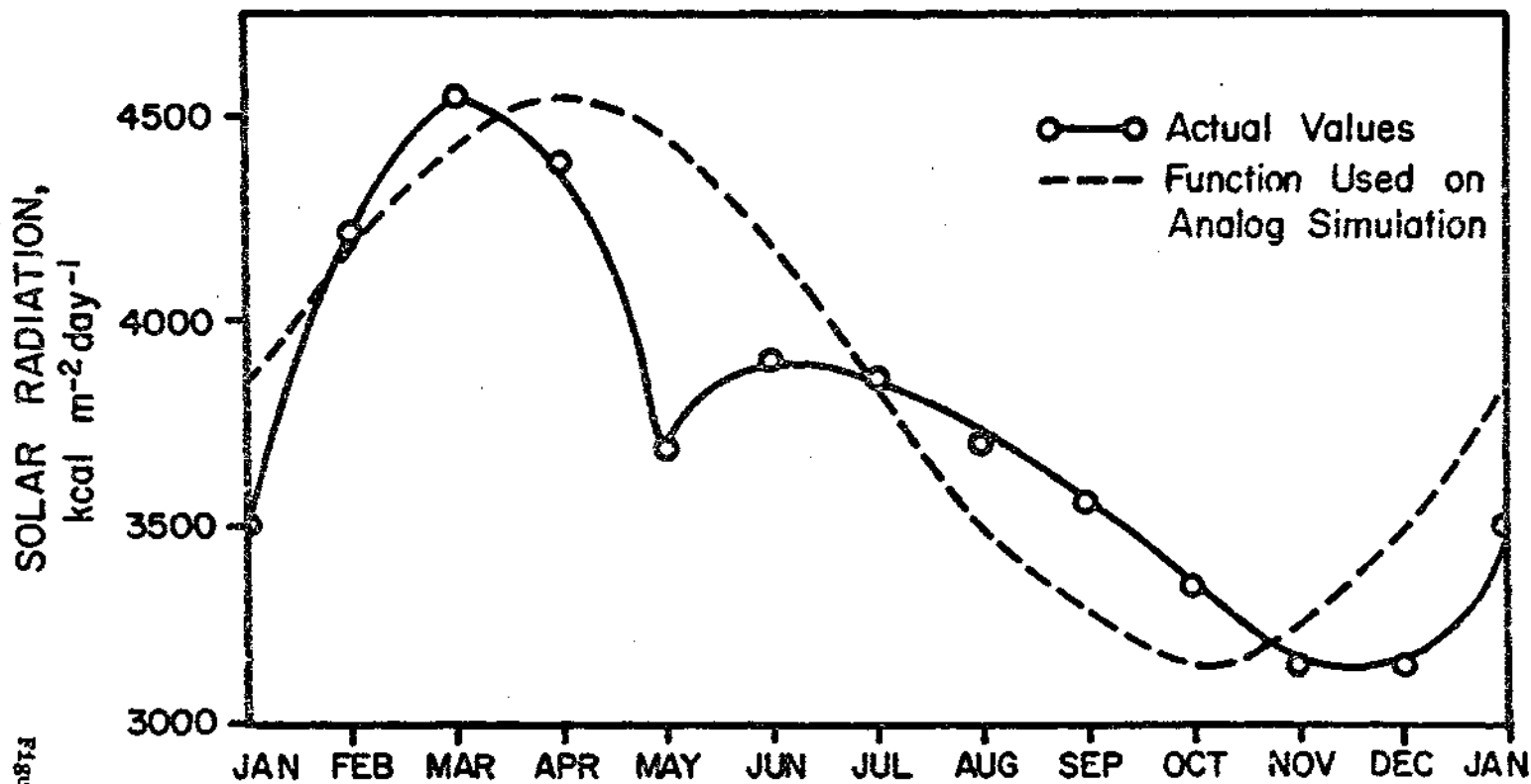

Figure 4

Seedlings in the trees

In an experiment in Florida Rhizophora mangle seedlings were found to weigh 12.6 grams (dry weight) for a seedling of length 31.7 centimeters. If the assumption is made that this seedling is six months old, then the yearly growth rate is 12.6 grams per seedling. A density of about 26 seedlings per square meter was counted in the trees in July 1972. Therefore, growth of seedlings is at least 327 grams per square meter per year. For this simulation a value of 660 grams per square meter per year was chosen.

Seedlings in the water

The number of seedlings falling from the trees into the water to be carried away by the tidal currents was calculated by estimating the amount of tree overhang above the water and determining the total length of waterways in Vietnam. The overhang was about three meters in Florida and the Rung Sat has about 500 km of waterways in the unsprayed area. The sprayed area also has another 500 km of waterways. Before spraying the number of seedlings that could be in water would therefore be about 1×10^8 seedlings. Seedling movement was calculated on the basis of a period of sixty days during which the seedlings fall from the trees into the water.

Bare land and land covered with live mangroves

The total area of the Rung Sat was already given previously as 750 km². If the woodcutters are assumed to have some influence on the amount of bare land, then the initial conditions should consider this. Therefore, bare land initially will occupy 50 km² of the Rung Sat and seeded land the remaining 700 km².

The above sections are a brief insight into what procedures were followed to obtain data for this simulation. As one can plainly see, much of the data has been only roughly approximated. Hopefully, more reliable field data will be obtained for the mangroves in the Rung Sat some time in the future. Initial

numerical values for the state variables and process variables are given in Figure 3 and Table 2.

In addition to describing the methods of getting the data, this methods section will also deal with the procedures that need to be followed for a computer simulation. The method used for this simulation involved describing each pathway by an equation that was a linear or nonlinear function of the variables and outside forcing functions discussed in an earlier part of this paper. When these functional relationships have been defined, the rate coefficients can be determined for the pathways. Equations are also written showing the time rate of change of a given state variable based on the inflows and outflows for that state variable. Also, for this simulation an analog computer was used and this meant that each time rate of change equation had to be scaled. These procedures will now be discussed.

Pathway equations

Figure 5 is another diagram of the model and is identical to Figure III-3 except that each pathway has been described by an equation. For example, the rate of gross photosynthesis is given as being equal to some rate coefficient, k_3 , times the land area covered with live mangroves, Q_2 , times available sunlight, Q_3 . In other words gross photosynthesis equals $k_3 Q_2 Q_3$. Similarly, one can determine the equations for the rest of the pathways.

Calculation of rate coefficients

Now that the pathway equations are known, one can begin to calculate the rate coefficients or k 's. To determine the value for a rate coefficient set the equation for a given pathway equal to the numerical value of the rate of flow for that pathway. Substitute for all the known values and solve for k , the rate coefficient. As an example, let's use the mangrove respiration pathway, $k_6 Q_5$:

TABLE 2

Descriptions and Quantification of Forcing Functions,
State Variables and Flow Processes Between State Variables

ITEM OF INTEREST	DESCRIPTION	VALUE
Forcing Functions		
S	Solar energy flux hitting the mangroves of the Rung Sat	Approximately sinusoidal (See Table 1 and Figure 1) units of $\text{kcal km}^{-2} \text{ day}^{-1}$ ($\text{kcal km}^{-2} \text{ yr}^{-1}$)
H	Herbicide application to mangroves of the Rung Sat by the U.S. Military	91,525 gal. (355,000 liters) in 1966 361,435 gal. (1,400,000 liters) in 1967 407,175 gal. (1,580,000 liters) in 1968 127,500 gal. (494,000 liters) in 1969 21,400 gal. (82,900 liters) in 1970
	Total	1,009,045 gal/3,911,900 liters ¹
N	External seedling source that may be needed to regenerate the mangroves. This may involve planting by some means (by hand, dropping from planes, etc.)	18×10^6 seedlings day^{-1} (540×10^6 seedlings mo^{-1}) would be the maximum value to give an instant mangrove forest in 50 days; figure based on Moquillon's (1944) recommendation of 50 days to plant seedlings at a density of 20,000 per hectare
C	Cutting effort of the South Vietnamese in harvesting mangroves for charcoal & other uses	Not actually determined but will be a value that would yield a harvest rate of $.36 \times 10^6$ kgs day^{-1} (Flow #5) 1.0×10^7 kgs mo^{-1} 12×10^7 kgs yr^{-1}
State Variables		
Q ₁	Mangrove land that has been converted to bare land by herbicide spraying	Maximum value would be the estimated total mangrove area of 750 km^2 . Estimated value was 524 km^2 broken down by years as follows: 65 km^2 1966 359 km^2 1967 100 km^2 1968

TABLE 2 (cont'd)

ITEM OF INTEREST	DESCRIPTION	VALUE
State Variables		
Q ₂	Land occupied by mangroves in the Rung Sat	750 km ² prior to spraying by U.S. Military possibly reduced to 226 km ² by 1968
Q ₄	Seedlings that are present in the water at any chosen period in time for the entire Rung Sat	Maximum value of seedlings 2×10^8 Average value of seedlings 1.0×10^8
Q ₅	Total biomass of the Rung Sat mangroves	Maximum value of 7.5×10^9 kgs (10,000 gms m ⁻²) Average value of 3.75×10^9 kgs (5,000 gms m ⁻²)
Q ₆	Seedlings that are present on the mangroves of the Rung Sat	Maximum value of seedlings 7.65×10^{10} Average value of seedlings 1.95×10^{10}
Process Variables		
1	Flow of solar energy flux	Annual variation can be approximated by a sine wave of maximum value 4550×10^6 kcal km ⁻² day ⁻¹ 1.66×10^{12} kcal km ⁻² yr ⁻¹ and minimum value 3150×10^6 kcal km ⁻² day ⁻¹ 1.15×10^{11} kcal km ⁻² yr ⁻¹
2	Flow of solar energy flux into multiplier interaction with seeded land	Annual variation also approximated by a sine wave of maximum values 50% of flow #1 units of kcal km ⁻² day ⁻¹ (kcal km ⁻² yr ⁻¹)
3	Flow into mangrove biomass compartment in terms of gross production	12×10^6 kgs day ⁻¹ 4380×10^6 kgs yr ⁻¹
4	Harvest rate of woodcutters to use mangrove wood for making charcoal and other uses	$.36 \times 10^6$ kgs day ⁻¹ 120×10^6 kgs yr ⁻¹
5	Respiration and other losses (litter fall, etc) in mangrove biomass	12×10^6 kgs day ⁻¹ 4380×10^6 kgs yr ⁻¹

TABLE 2 (cont'd)

ITEM OF INTEREST	DESCRIPTION	VALUE
Process Variables		
6	Rate of mangrove biomass going into seedling production	2.7×10^6 kgs day ⁻¹ 490×10^6 kgs yr ⁻¹
7	Rate at which seedlings appear on mangroves	1.08×10^8 seedlings day ⁻¹ 1.94×10^{10} seedlings yr ⁻¹ for a month period from April - October each year
8	Loss rate of seedlings to disease, meteorological conditions, predators	Assume 10% of flow 7 or $.108 \times 10^8$ seedlings/day ⁻¹ $.194 \times 10^{10}$ seedling/yr ⁻¹
9	Rate at which seedlings fall from the mangroves (in Oct. and Nov. mostly)	3.25×10^8 seedlings day ⁻¹ ; 1.94×10^{10} seedlings/yr ⁻¹ over a two month period each year
10	Rate at which seedlings make it into the water for colonization of other areas	0.7×10^6 seedlings/day ⁻¹ ; 4.2×10^7 seedlings/yr ⁻¹ over the two month interval mentioned for Flow 9
11	Loss rate of seedlings that are in the water	0.35×10^6 seedlings/day ⁻¹ 4.2×10^7 seedlings/yr ⁻¹
12	Rate of seedlings colonizing bare land for conversion to mangrove land	0.7×10^6 seedlings/day ⁻¹ 4.2×10^7 seedlings/yr ⁻¹
13	Rate of application of herbicide by military over the Rung Sat	355,000 liters 1966; 1,400,000 liters 1967; 1,580,000 liters 1968; 494,000 liters 1969; 82,900 liters 1970
14	Rate of conversion of Mangrove land into bare land as a result of spraying	(65 liters/yr ⁻¹) 1966; (359 liters/yr ⁻¹) 1967 (100 liters/yr ⁻¹) 1968
15	Rate of conversion of bare land to mangrove land thru natural regeneration	$25.6 \text{ km}^2/\text{yr}^{-1}$
16	Planting rate	Variable

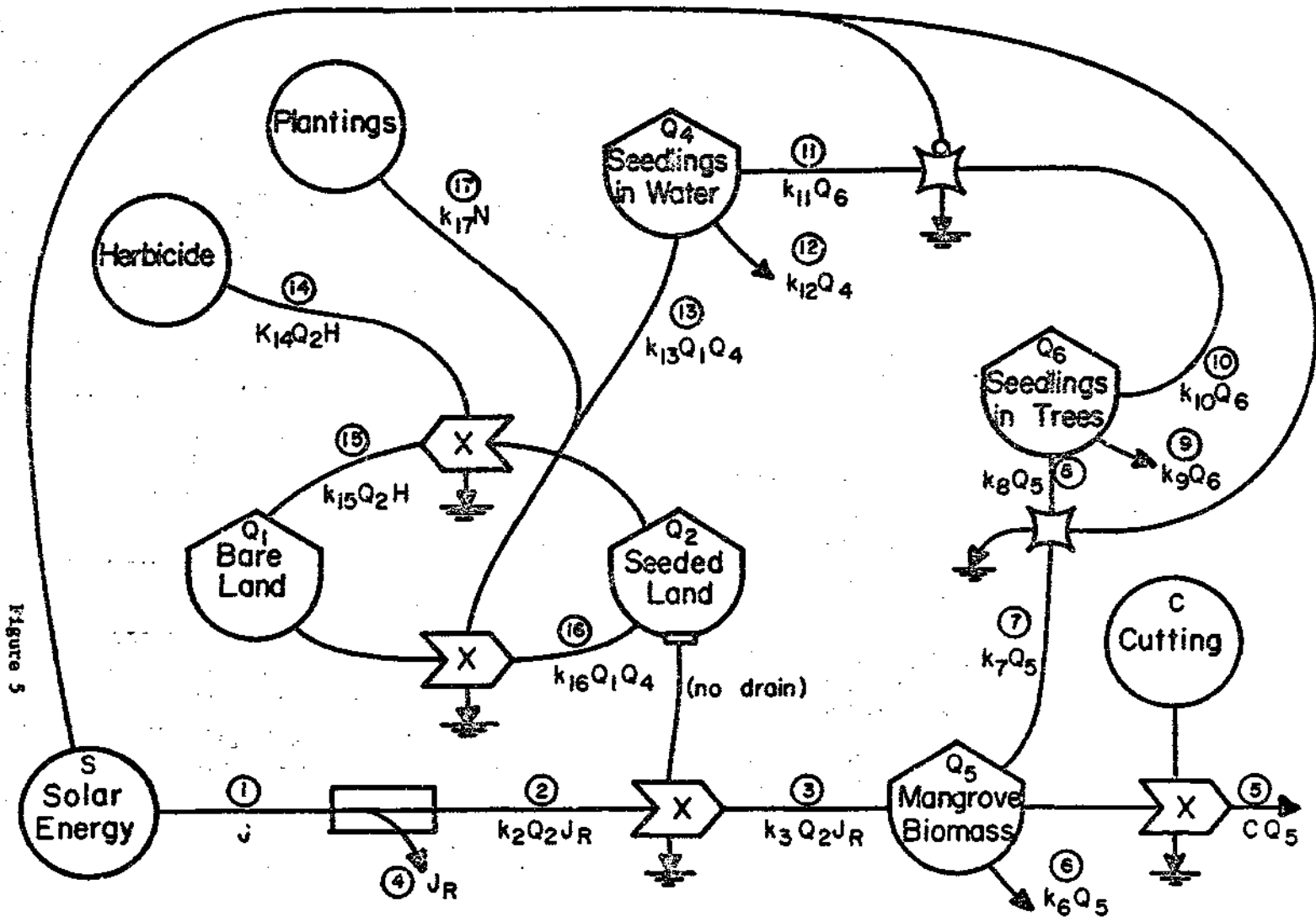

Figure 5

$$k_6 Q_5 = 2.19 \times 10^9 \text{ kg year}^{-1} \quad (1)$$

$$k_6 = \frac{2.19 \times 10^9}{3.75 \times 10^9} = 0.585 \text{ year}^{-1}$$

Calculations for the rate coefficients are shown in Table 3. Values for all of the rate coefficients are given in Table 4.

Differential equation writing

For each state variable of interest a differential equation can be written. All this says is that the time rate of change of variable is equal to all the input rates minus all the output rates for the state variable in question. Let's look at the level of mangrove biomass as an example. The rate of change of mangrove biomass, dQ_5/dt , is equal to the incoming rate of biomass production, $k_3 Q_2 J_R$, minus the amounts lost through plant respiration, $k_6 Q_5$, through woodcutting, $c Q_5$, and through some amount needed for growth of seedlings, $k_7 Q_5$. In equation form this becomes

$$\frac{dQ_5}{dt} = k_3 Q_2 J_R - k_6 Q_5 - c Q_5 - k_7 Q_5 = Q_5 \quad (2)$$

The differential equations for all the state variables are given in Table 5.

Scaling equations for analog computer use

Because the decision was made to run the simulation on an analog computer, it was necessary to scale all of the differential equations describing the state variables. Scaling is required because analog computers have built into them a maximum voltage output constraint. Exceeding this value may yield erroneous results. For scaling, each state variable is assigned some maximum level that

TABLE 3

CALCULATION OF RATE COEFFICIENTS FOR THE
PATHWAYS THAT OCCUR IN THE MANGROVE MODEL (FIGURE III-3)

Flow #2 - Incoming Flux of Sunlight, $k_2Q_2J_R$

$$k_2Q_2J_R = .83 \times 10^{12} \text{ kcal m}^{-2} \text{ yr}^{-1}$$

$$k_2 = \frac{.83 \times 10^{12}}{.83 \times 10^{14}(700)}$$

$$k_2 = 1.43 \times 10^{-3} \text{ km}^{-2}$$

Flow #3 - Gross photosynthesis for mangroves, $k_3Q_2Q_3$

$$k_3Q_2Q_3 = 4.38 \times 10^9 \text{ kg yr}^{-1}$$

$$k_3 = \frac{4.38 \times 10^9}{.83 \times 10^{12}(700)}$$

$$k_3 = 7.54 \times 10^{-6} \text{ kcal}^{-1}$$

Flow #4 - Rate at which woodcutters are cutting wood, cQ_5

$$cQ_5 = .12 \times 10^9 \text{ kg yr}^{-1}$$

$$c = \frac{.12 \times 10^9}{3.75 \times 10^9}$$

$$c = 3.06 \times 10^{-2} \text{ yr}^{-1}$$

Flow #5 - Respiration of mangroves, k_6Q_5

$$k_6Q_5 = 2.19 \times 10^9 \text{ kg yr}^{-1}$$

$$k_6 = \frac{2.19 \times 10^9}{3.75 \times 10^9}$$

$$k_6 = .585 \text{ yr}^{-1}$$

Flow #6 - Rate at which biomass is translocated to seedlings, l_7Q_5

$$l_7Q_5 = .491 \times 10^9 \text{ kg yr}^{-1}$$

$$l_7 = \frac{.491 \times 10^9}{3.75 \times 10^9}$$

$$l_7 = 1.311 \times 10^{-1} \text{ yr}^{-1}$$

Flow #7 - Rate at which seedlings are produced, Q_5

$$k_8 Q_5 = 1.94 \times 10^{10}$$

$$k_8 = \frac{1.94 \times 10^{10}}{3.75 \times 10^9}$$

$$k_8 = 5.17 \text{ seedlings } kg^{-1} \text{ yr}^{-1}$$

Flow #8 - Rate at which seedlings go into the water to colonize new areas, $k_9 Q_6$

$$k_9 Q_6 = 3.94 \times 10^9 \text{ seedlings yr}^{-1}$$

$$k_9 = \frac{3.94 \times 10^9}{1.95 \times 10^{10}}$$

$$k_9 = 2.02 \times 10^{-1} \text{ yr}^{-1}$$

Flow #9 - Rate at which seedlings remain beneath the parent trees, $k_{10} Q_6$

$$k_{10} Q_6 = 1.95 \times 10^{10} \text{ seedlings yr}^{-1}$$

$$k_{10} = \frac{1.95 \times 10^{10}}{1.95 \times 10^{10}}$$

$$k_{10} = 1.0 \text{ yr}^{-1}$$

Flow #10 - Rate at which seedlings are available to actually colonize new areas,

$$k_{11} Q_6$$

$$k_{11} Q_6 = 42 \times 10^6 \text{ seedlings yr}^{-1}$$

$$k_{11} = \frac{42 \times 10^6}{1.95 \times 10^{10}}$$

$$k_{11} = 2.15 \times 10^{-3} \text{ yr}^{-1}$$

Flow #11 - Rate of loss of seedlings that are in the water, $k_{12} Q_4$

$$k_{12} Q_4 = 2.1 \times 10^7 \text{ seedlings yr}^{-1}$$

$$k_{12} = \frac{2.1 \times 10^7}{.2 \times 10^8}$$

$$k_{12} = 1.05 \text{ yr}^{-1}$$

Flow #12 - Rate at which seedlings colonize new areas, $k_{13} Q_1 Q_4$

$$k_{13} Q_1 Q_4 = 42 \times 10^6 \text{ seedlings yr}^{-1}$$

$$k_{13} = \frac{42 \times 10^6}{(50)(.2 \times 10^8)}$$

$$k_{13} = 4.2 \times 10^{-2} \text{ yr}^{-1}$$

Flow #13 - Rate of conversion of seeded land to bare land (maximum value), $k_{15}Q_2H$

$$k_{15}Q_2H = 365 \text{ km}^2 \text{ yr}^{-1}$$

$$k_{15} = \frac{365}{(1.095 \times 10^6)(700)}$$

$$k_{15} = 4.8 \times 10^{-7} \text{ liters}^{-1} \text{ yr}^{-1}$$

Flow #14 - Rate of conversion of bare land to seeded land, $k_{16}Q_1Q_4$

$$k_{16}Q_1Q_4 = 25.6 \text{ km}^2 \text{ yr}^{-1}$$

$$k_{16} = \frac{25.6}{(50)(.2 \times 10^9)}$$

$$k_{16} = 2.56 \times 10^{-8} \text{ seedlings}^{-1} \text{ yr}^{-1}$$

Flow #15 - Variable Planting Rate

TABLE 4

Values Used for Rate Coefficients in
Mangrove Model of South Vietnam

Flow Number (1)	Coefficient	Coefficient Value
1	-----	
2	k_2	$1.43 \times 10^{-3} \text{ km}^{-2}$
3	k_3	$7.54 \times 10^{-6} \text{ kg kcal}^{-1}$
4	c	$3.06 \times 10^{-2} \text{ yr}^{-1}$
5	k_6	$5.85 \times 10^{-1} \text{ yr}^{-1}$
6	k_7	$1.311 \times 10^{-1} \text{ yr}^{-1}$
7	k_8	$5.17 \text{ seedlings kg}^{-1} \text{ yr}^{-1}$
8	k_9	$2.02 \times 10^{-1} \text{ yr}^{-1}$
9	k_{10}	1.0 yr^{-1}
10	k_{11}	$2.15 \times 10^{-3} \text{ yr}^{-1}$
11	k_{12}	1.05 yr^{-1}
12	k_{13}	$4.2 \times 10^{-2} \text{ km}^{-2} \text{ yr}^{-1}$
13	H	sine wave pulse
14	k_{15}	$4.8 \times 10^{-7} \text{ liters}^{-1}$
15	k_{16}	$2.56 \times 10^{-8} \text{ seedlings}^{-1} \text{ yr}^{-1}$
16	N	variable yr^{-1}

TABLE 5

Differential Equations that Describe the State Variables Appearing in the Model (Figure III-5)

1) Bare Land

$$\dot{Q}_1 = k_{15}Q_2H - k_{16}Q_1Q_4$$

2) Seeded Land

$$Q_2 = A - Q_1$$

where A is the total land area of the Rung Sat

3) Available Light

$$J_R = J - k_2J_RQ_2$$

4) Seedlings in the Water

$$\dot{Q}_4 = k_{11}Q_6 - k_{12}Q_4 - k_{13}Q_1Q_4$$

5) Mangrove Biomass

$$\dot{Q}_5 = k_3Q_2J_R - k_6Q_5 - k_7Q_5 - cQ_5$$

6) Seedlings in the trees

$$\dot{Q}_6 = k_8Q_5 - k_{10}Q_6 - k_9Q_6$$

is not expected to be exceeded. To illustrate, the initial value for mangrove biomass was chosen as 4.2×10^6 tons (3.75×10^9 kgs) for the entire Rung Sat and the maximum value was chosen to be twice that amount. Maximum values for the state variables are given in Table 2.

The following steps are involved in the scaling process:

- (1) Write the differential equation that describes the time rate of change of a state variable. As an example, mangrove biomass will be used.

$$\frac{dQ_5}{dt} = k_3 Q_2 J_R - k_6 Q_5 - c Q_5 - k_7 Q_5$$

- (2) Divide and multiply each variable on the right side of the equation by its maximum value. This gives the following result

$$\frac{dQ_5}{dt} = k_3 (750) \left[\frac{Q_2}{750} \right] 3.26 \times 10^{12} \left[\frac{J_R}{3.26 \times 10^{12}} \right] - k_6 (7.5 \times 10^9) \left[\frac{Q_5}{7.5 \times 10^9} \right] - k_7 (7.5 \times 10^9) \left[\frac{Q_5}{7.5 \times 10^9} \right] - c (7.5 \times 10^9) \left[\frac{Q_5}{7.5 \times 10^9} \right] \quad (3)$$

- (3) Divide both sides of the equation by the maximum value for the state variable on the left side of the equation to give

$$\frac{dQ_5/dt}{7.5 \times 10^9} = k_3 (3.26 \times 10^5) \left[\frac{Q_2}{750} \right] \left[\frac{J_R}{3.26 \times 10^{12}} \right] - k_6 \left[\frac{Q_5}{7.5 \times 10^9} \right] - k_7 \left[\frac{Q_5}{7.5 \times 10^9} \right] - c \left[\frac{Q_5}{7.5 \times 10^9} \right] \quad (4)$$

Equation (4) is the scaled equation that should be used for mangrove biomass.

All that needs to be done is to substitute the rate coefficient values into the equation. The numerical values that appear outside the brackets would be the pot settings for the analog diagram. All of the scaled equations are given in Table 6.

A diagram of the simulation model as it would appear in the language of analog computer symbols is shown in Figure 6. These symbols will not be explained here but any book on analog computers adequately explains the meaning of each symbol. Simulations were run on an Electronic Associates, Inc. analog computer, the EAI 680.

TABLE 6

Scaled Equations for Mangrove Model

1) Bare land

$$\frac{Q_1}{750} = 0.528 \left[\frac{Q_2}{750} \right] \left[\frac{H}{1.1 \times 10^6} \right] - 5.12 \left[\frac{Q_1}{750} \right] \left[\frac{Q_4}{2 \times 10^8} \right]$$

2) Land covered by mangroves

$$\frac{Q_2}{750} = 1 - \left[\frac{Q_1}{750} \right]$$

3) Seedlings in the water

$$\frac{Q_4}{2 \times 10^8} = 0.824 \left[\frac{Q_6}{7.65 \times 10^{10}} \right] - 1.05 \left[\frac{Q_4}{2 \times 10^8} \right] - 31.5 \left[\frac{Q_1}{750} \right] \left[\frac{Q_4}{2 \times 10^8} \right]$$

4) Mangrove biomass

$$\frac{Q_5}{7.5 \times 10^9} = 2.458 \left[\frac{J_R}{3.26 \times 10^{12}} \right] \left[\frac{Q_2}{750} \right] - 0.585 \left[\frac{Q_5}{7.5 \times 10^9} \right] - 0.1311$$

$$\left[\frac{Q_5}{7.5 \times 10^9} \right] - 0.0306 \left[\frac{Q_5}{7.5 \times 10^9} \right]$$

5) Seedlings hanging from trees

$$\frac{Q_6}{7.65 \times 10^{10}} = 0.507 \left[\frac{Q_5}{7.5 \times 10^9} \right] - 1.0 \left[\frac{Q_6}{7.65 \times 10^{10}} \right] - 0.202 \left[\frac{Q_6}{7.65 \times 10^{10}} \right]$$

6) Available Light

$$\frac{J_R}{3.26 \times 10^{12}} = \left[\frac{J}{3.26 \times 10^{12}} \right] - 1.072 \left[\frac{Q_2}{750} \right] \left[\frac{J_R}{3.26 \times 10^{12}} \right]$$

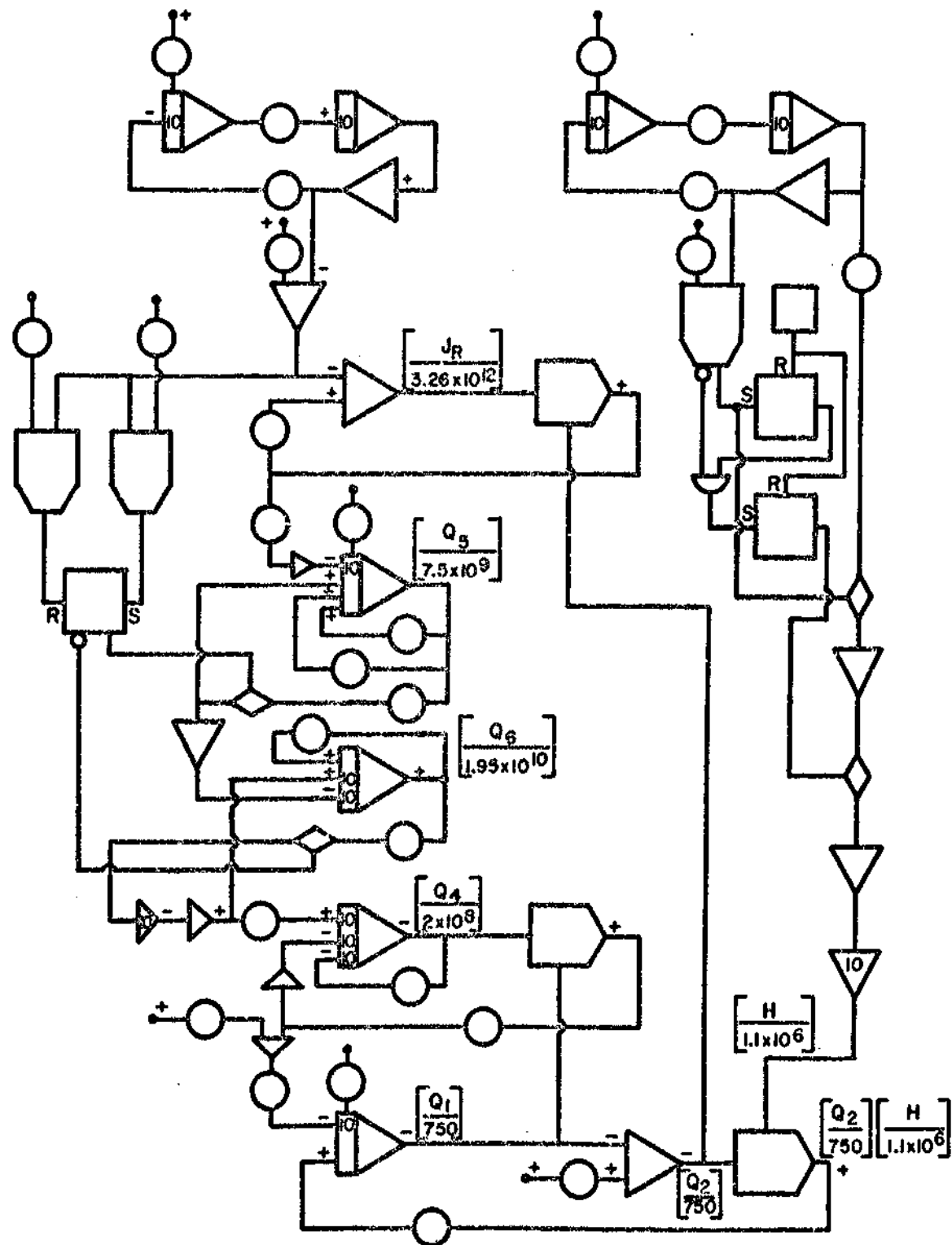

Figure 6

RESULTS

Several situations were simulated to assess the impact of selected pathways on the level of mangrove biomass. In most cases a family of curves will be shown in each figure. This was necessary because of the many approximations made to obtain data for the simulations. Another reason was the unavailability of data for the mangroves in the Rung Sat. By generating a family of curves for variables such as gross photosynthesis, woodcutting and herbicide spraying, the actual patterns followed by the Rung Sat mangroves may be included.

Steady-state conditions

What would the levels of mangrove biomass be if no spraying occurred and the woodcutters were cutting at the rate of 3% of the trees per year? Figure 7 shows the levels of mangrove biomass for several rates of gross photosynthesis. These rates were 3.5, 7, 14, and 19 grams of organic matter produced per square meter per day, respectively. To convert these values to pounds per acre, divide by 0.112. From an initial biomass of 5000 gms per m² steady state levels were reached in 8, 6, 10 and 12 years from the lowest to the highest rate of gross photosynthesis.

Figures 8a and 8b show the effect of woodcutting on mangrove biomass. In Figure 8a the rate of gross photosynthesis is 14 gms per m² per day. If no mangroves are cut, the mangroves attain a biomass level of 7200 gms per m². At cutting rates of 3%, 30%, 60%, and 300% of the trees, the steady state levels of biomass were 7000, 5000, 4000, and 1500 gms per m², respectively.

In Figure 8b the rate of gross photosynthesis was lowered to 7 gms per m² per day. In the absence of cutting, the mangroves would be able to attain a biomass of 4000 gms per m². Cutting rates of 3%, 30%, 60%, and 300%, would give mangrove biomass levels of 3800, 3000, 2200, and 900 gms per m², respectively, at steady state.

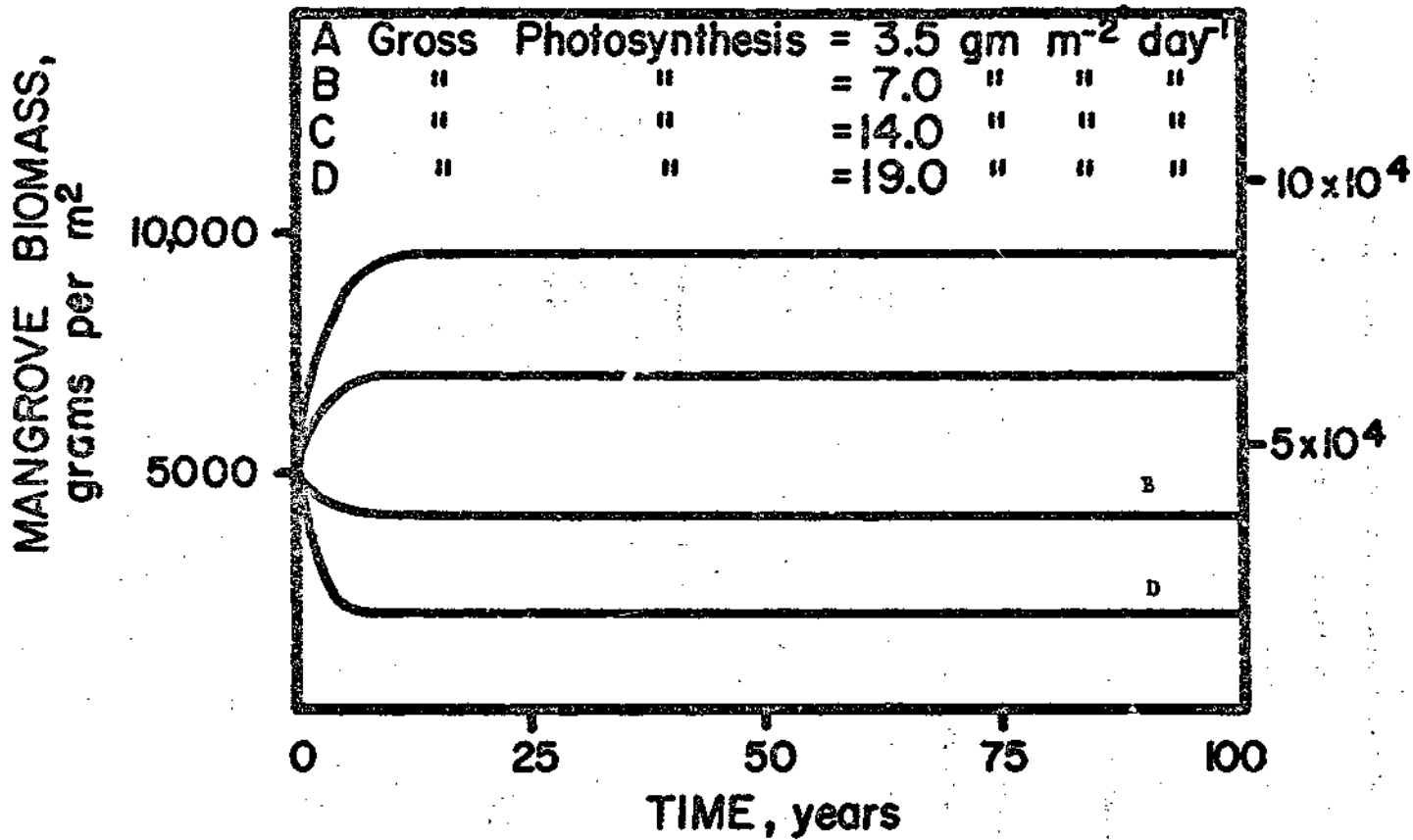

Figure 7

MANGROVE BIOMASS,
grams per m²

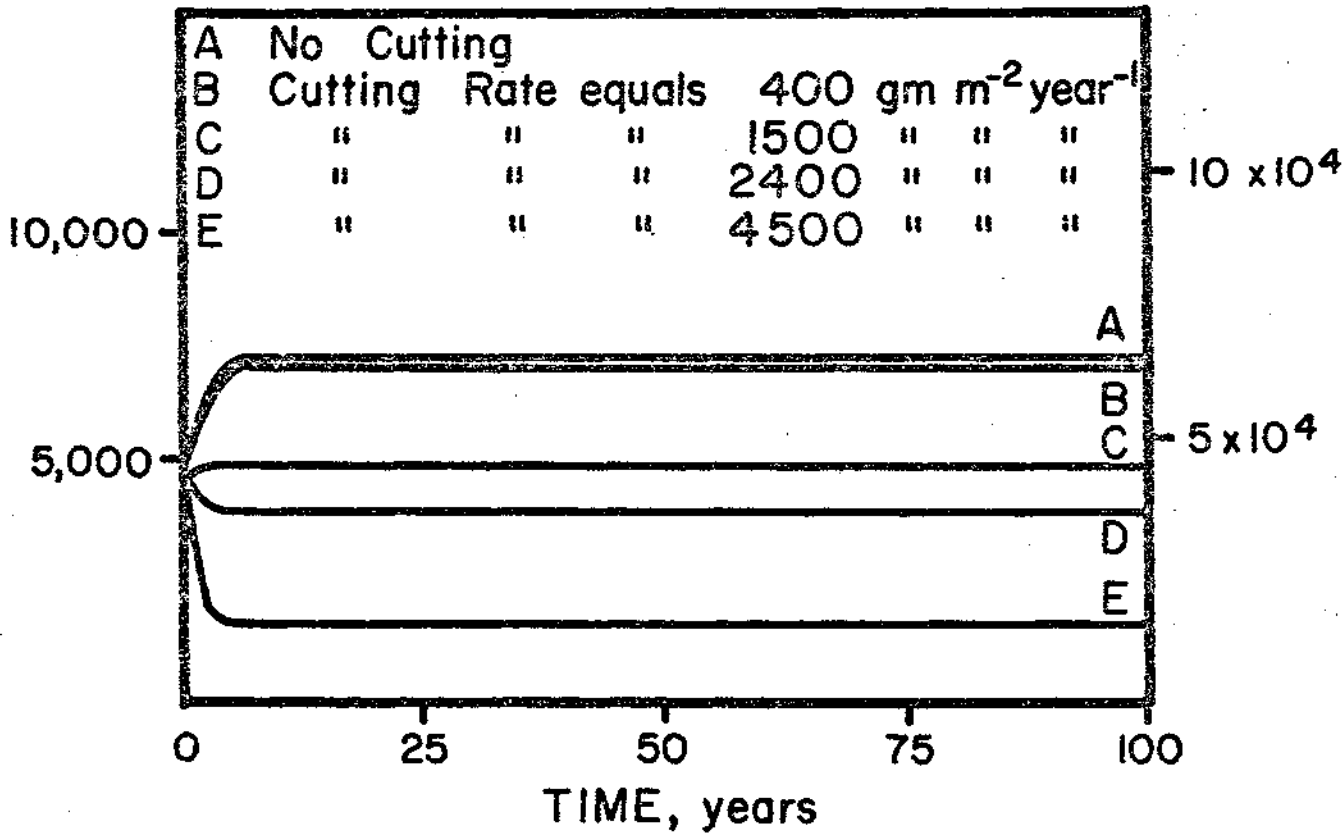
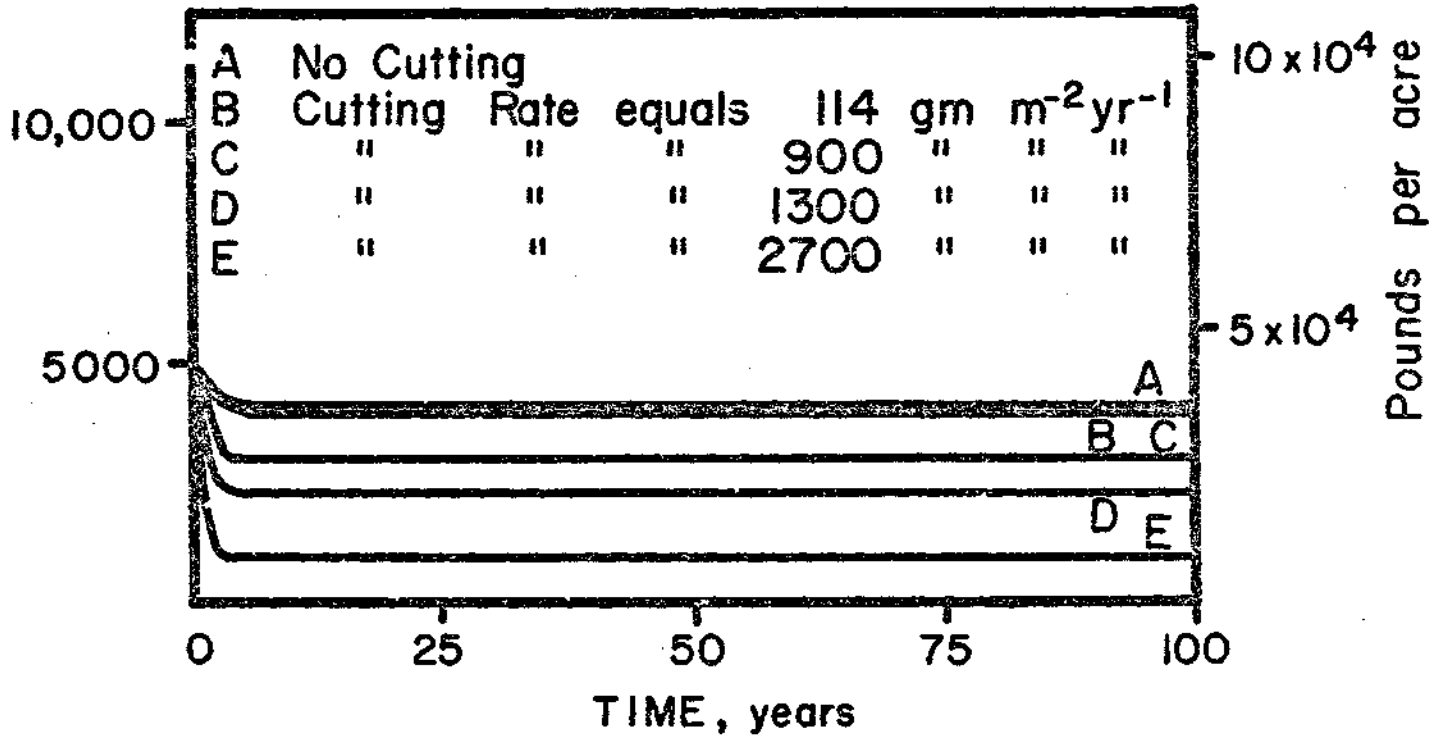

Figure 8a

Pounds per acre

Figure 8b

MANGROVE BIOMASS,
grams per m²



Herbicide intensity

In Figure 9 five intensities of herbicide spraying are shown occurring during a five year period. This is roughly the number of years widespread spraying occurred in the Republic of Vietnam (period from 1965 to 1970). The greatest level of spraying is represented by curve A which shows a maximum level of about 1.1 million liters sprayed for any one year. For the full five-year period this curve would give a total amount of herbicide sprayed of 3.5 million liters. For curve B the peak level was 0.55 million liters and the total was 1.66 million liters. Curves C, D, and E gave peak levels of 0.28, 0.14, and 0.05 million liters and total levels of 0.89, 0.45, and 0.16 million liters, respectively.

Effect of herbicide spraying

Figures 10a and 10b show the effect of herbicide spraying on mangrove land and mangrove biomass, respectively, when the rate of gross photosynthesis is only 3.5 gms per m^2 per day. In Figure 10a the land that the mangroves cover is reduced from 750 km^2 to 615, 410, 245, 140, or 25 km^2 at total herbicide dosages of 0.16, 0.45, 0.89, 1.66, or 3.5 million liters, respectively. To convert these values to acres multiply km^2 by 247. The times required for the land to be recolonized by mangroves would be 45, 65, 90, >100 and >>100 years at increasing rates of total herbicide dosage.

Figure 10b shows the effect of herbicide on mangrove biomass. At the five levels of total herbicide dosage of 0.16, 0.45, 0.89, 1.66 and 3.5 million liters, mangrove biomass was reduced to 2100, 1500, 1200, 700 and 200 gms per m^2 , respectively, from an initial steady state biomass level of 2000 gms per m^2 . The mangroves returned to the initial level of biomass in 10, 40, 60, 90, or >100 years depending on the total herbicide dosage applied during the five-year period. As spraying increased, so did the time for complete recolonization to initial steady state levels.

Figures 11a and 11b show the effect of herbicide on mangrove land and

Figure 6

HERBICIDE SPRAY,

liters

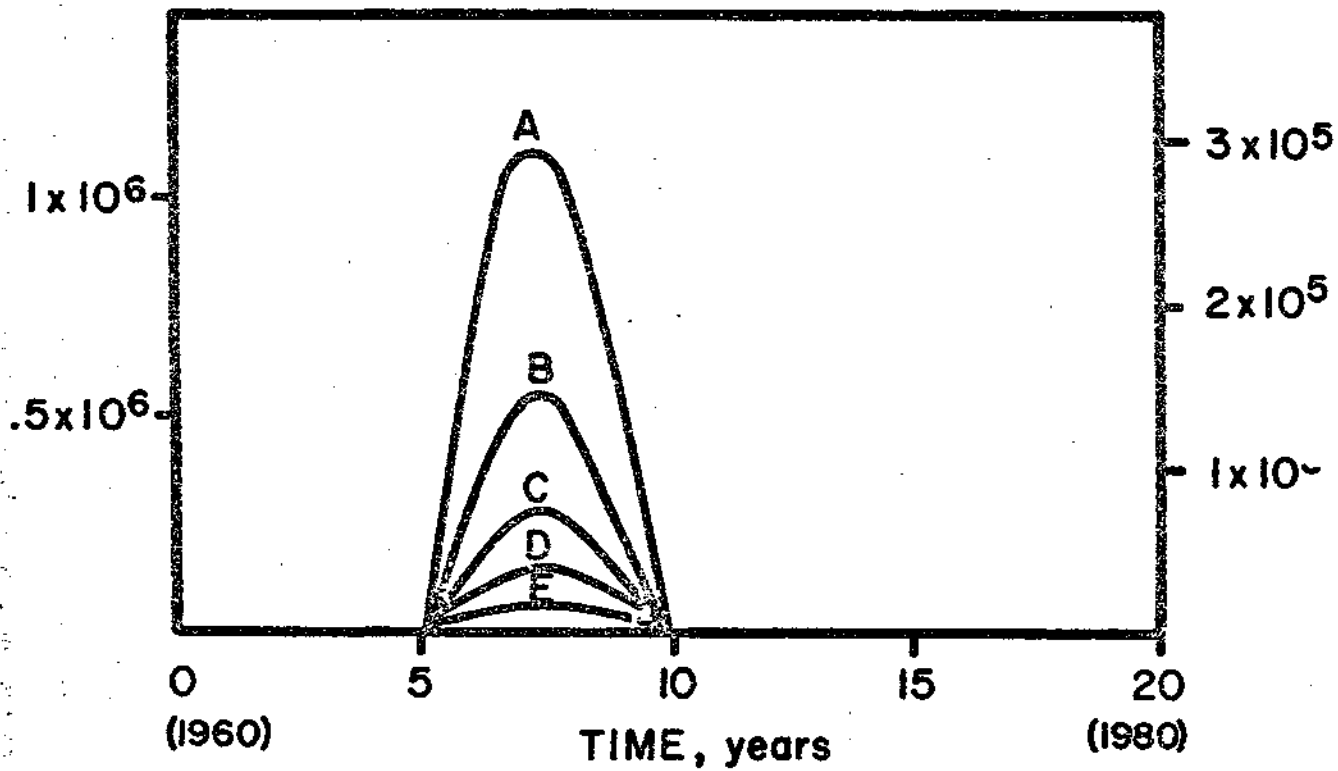

gallons

Figure 10a

LAND AREA COVERED BY MANGROVES, km²

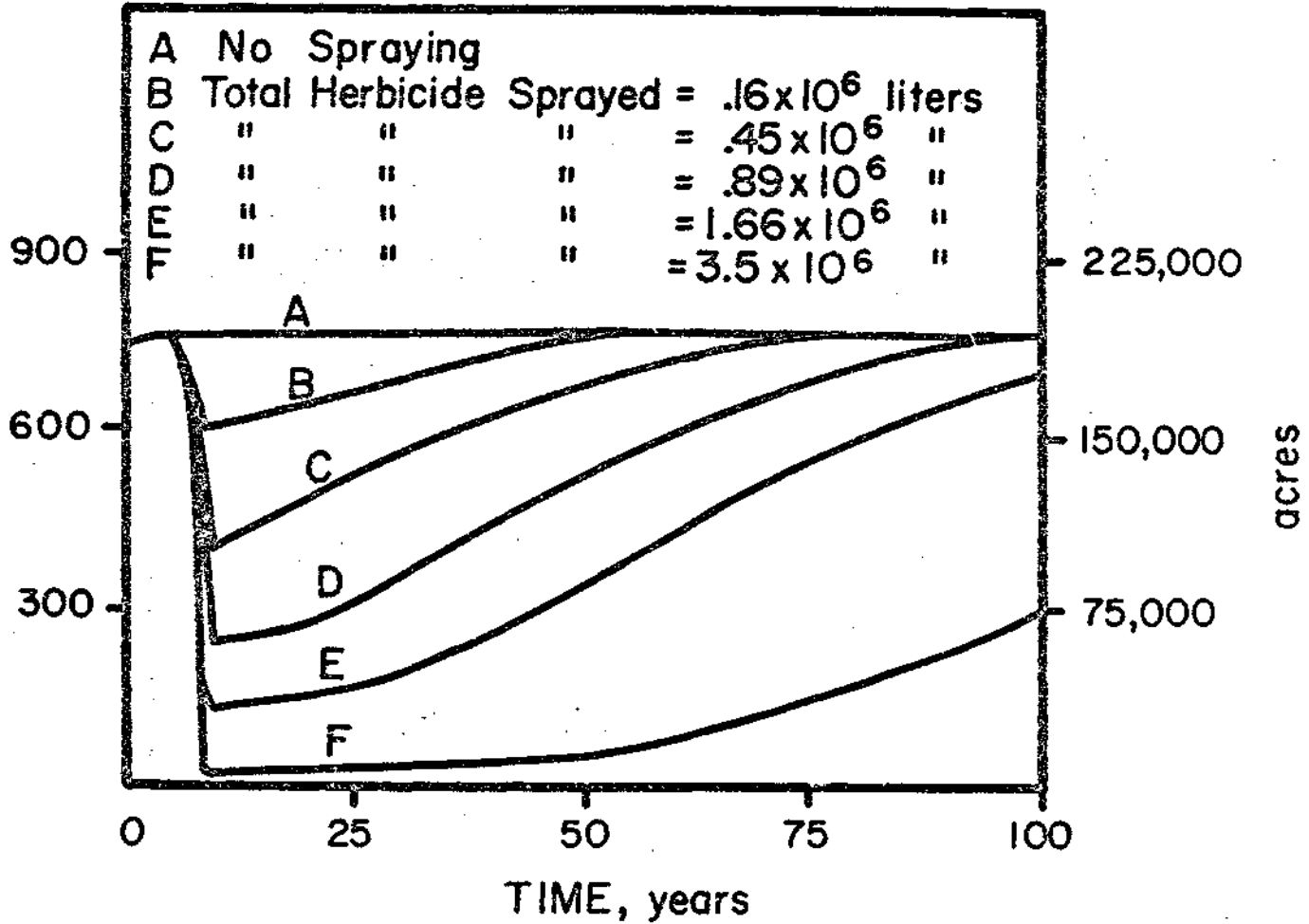

MANGROVE BIOMASS,
grams per m²

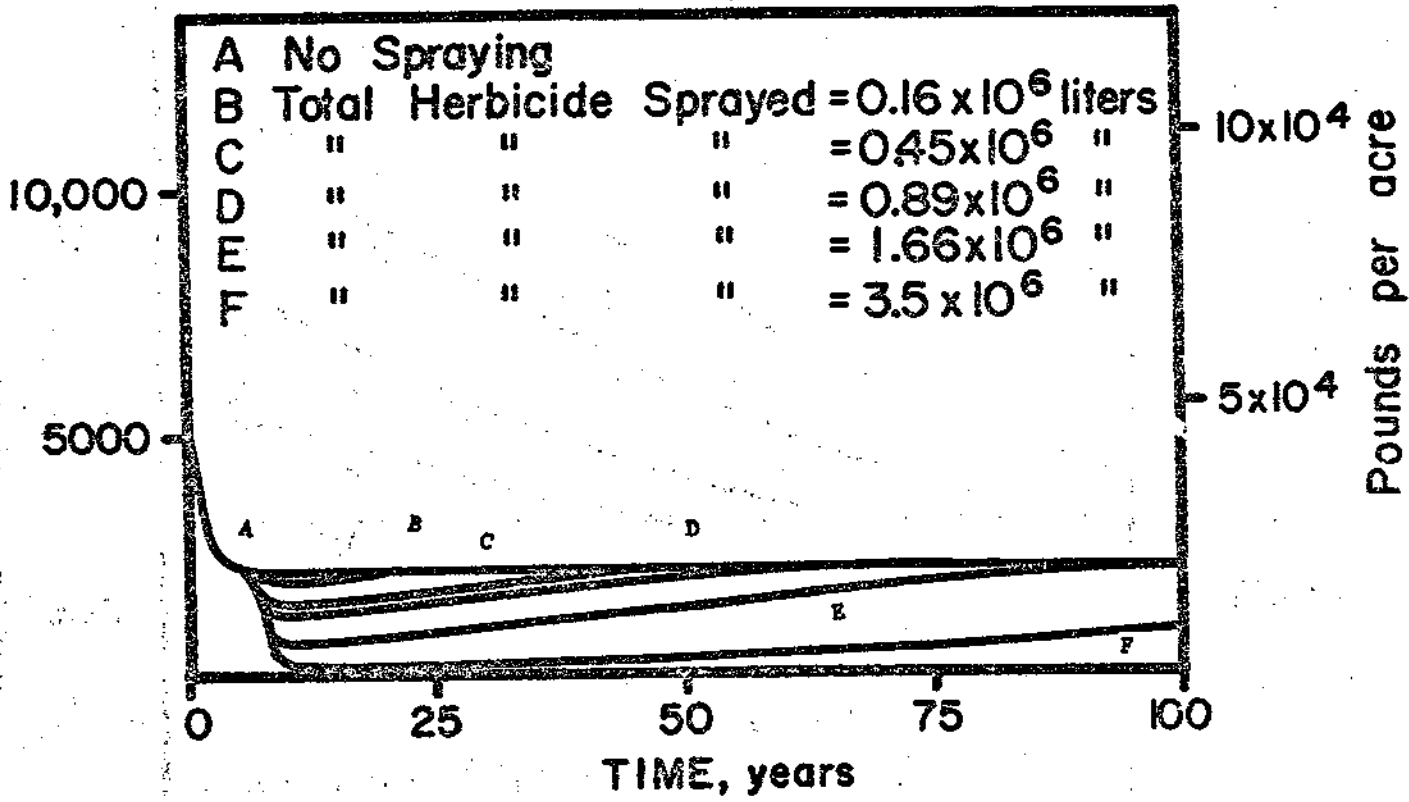

Figure 10b

LAND AREA COVERED
BY MANGROVES, km²

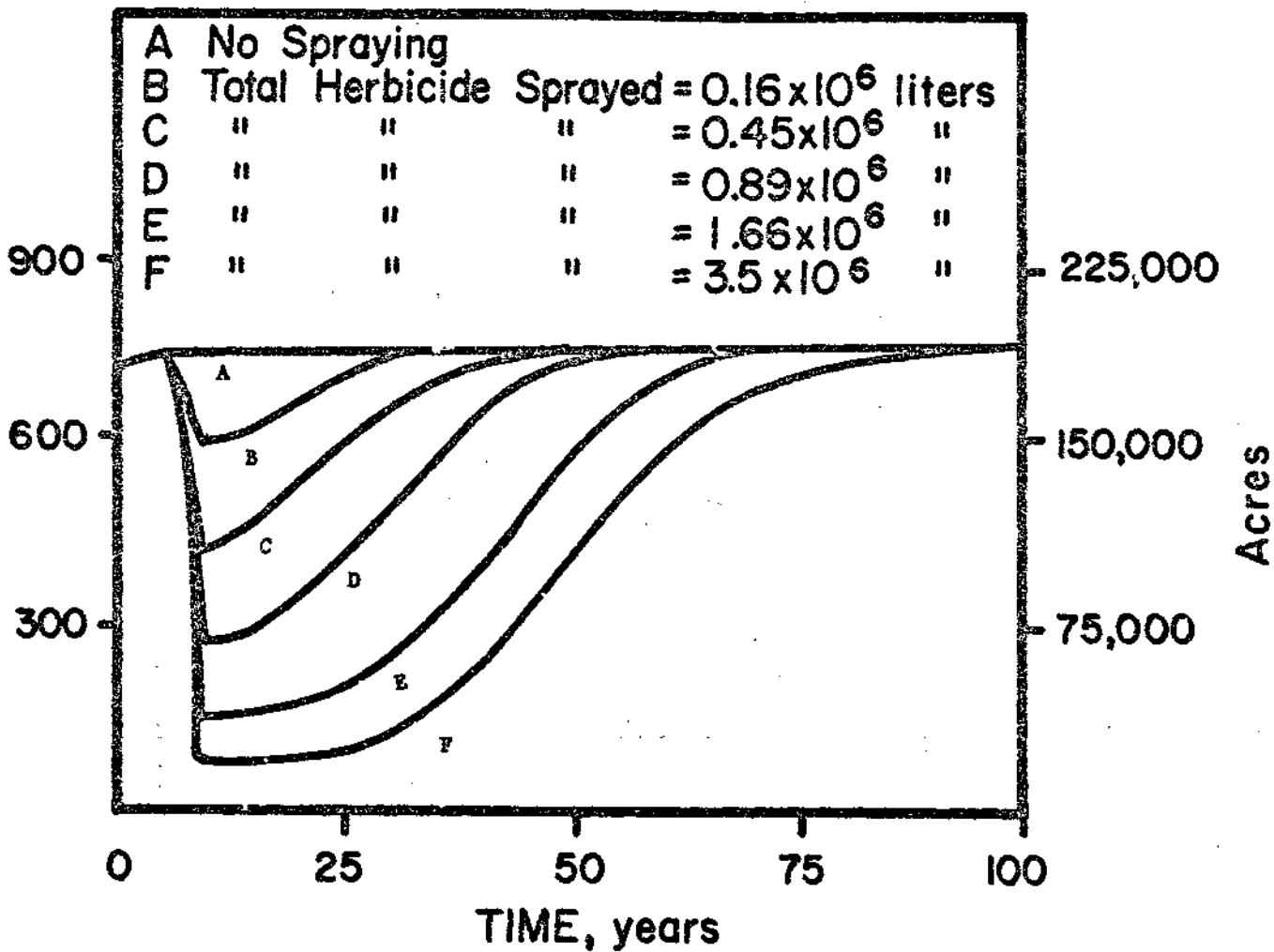
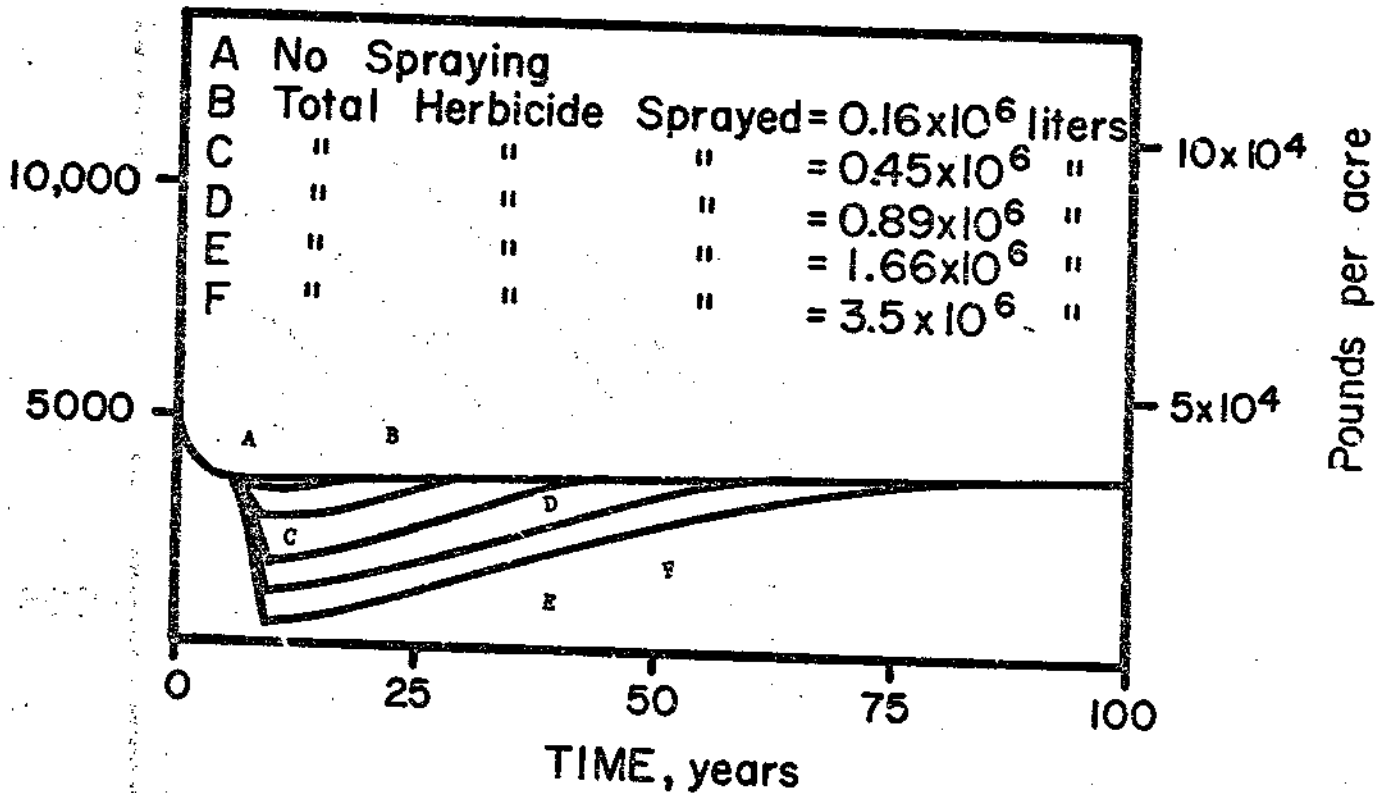

Figure 11a

Figure 11b

MANGROVE BIOMASS,
grams per m²



mangrove biomass when the rate of gross photosynthesis was 7 gms per m^2 per day. In Figure 11a the land covered with mangroves was reduced to 600, 430, 275, 150, or 75 km^2 at herbicide dosages of 0.16, 0.45, 0.89, 1.66 and 3.5 million liters. The times required for recolonization of the land were 20, 35, 50, 60, and 80 years as spraying increased from lowest to highest rate.

Figure 11b shows the effect of herbicide on mangrove biomass. From an initial steady state biomass of 3800 gms per m^2 the biomass level was reduced to 3400, 2800, 1800, 1200 and 500 gms per m^2 from the lowest to the highest amounts of herbicide dosage. The mangroves returned to the pre-spraying levels in 10, 20, 30, 50, or 75 years after spraying at the various levels of herbicide.

Figures 12a and 12b show the effect of herbicide on mangrove land and mangrove biomass when the rate of gross photosynthesis was 14 gms per m^2 per day. In Figure 12a the mangrove land area was reduced from 750 km^2 to 660, 470, 310, 160, or 80 km^2 at herbicide dosages of 0.16, 0.45, 0.89, 1.66 or 3.5 million liters sprayed over the five-year period. The times required for recolonization of the sprayed areas were 15, 25, 35, 45, or 60 years for increasing levels of herbicide.

In Figure 12b mangrove biomass was reduced from 7000 gms per m^2 to 6600, 5700, 4000, 2500, or 1100 gms per m^2 depending on the level of herbicide application. The mangroves returned to pre-spraying biomass level in 10, 20, 25, 30, or 40 years at the selected herbicide dosages.

Figures 13a and 13b show the effect of herbicide spraying and a 30% cutting rate on the mangrove land area and the mangrove biomass. In Figure 13a mangrove land area is reduced to 655, 510, 350, 220, or 55 km^2 at the five levels of herbicide application. The times required for recolonization were 15, 25, 35, 45, or 65 years.

In Figure 13b mangrove biomass is reduced from 5400 gms per m^2 to 4800, 4100, 2600, 1300, or 700 gms per m^2 at the five levels of herbicide application.

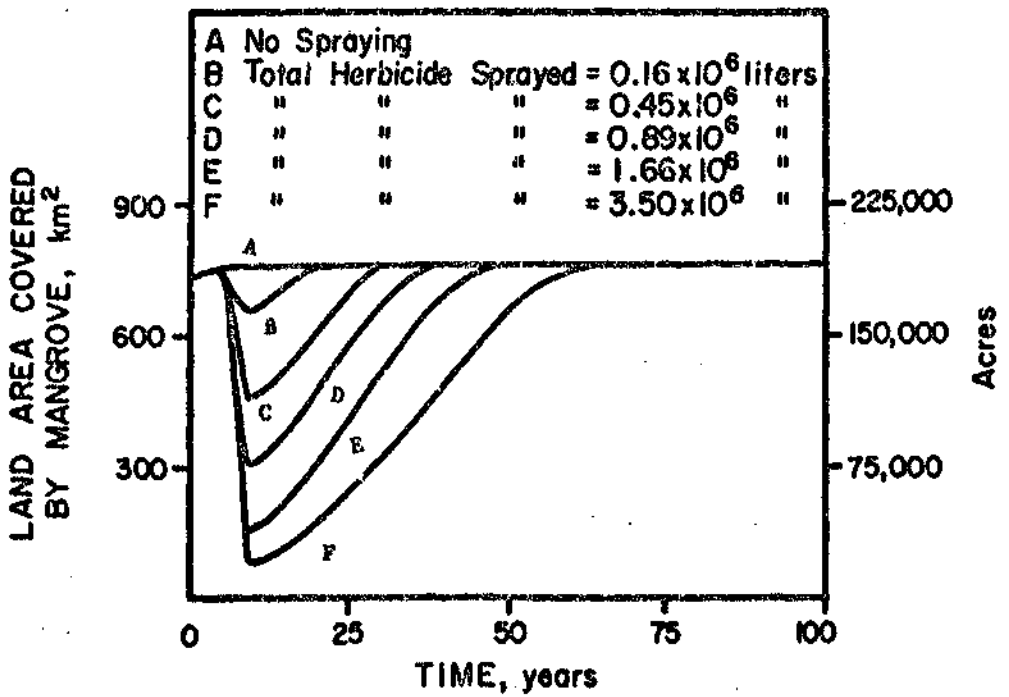
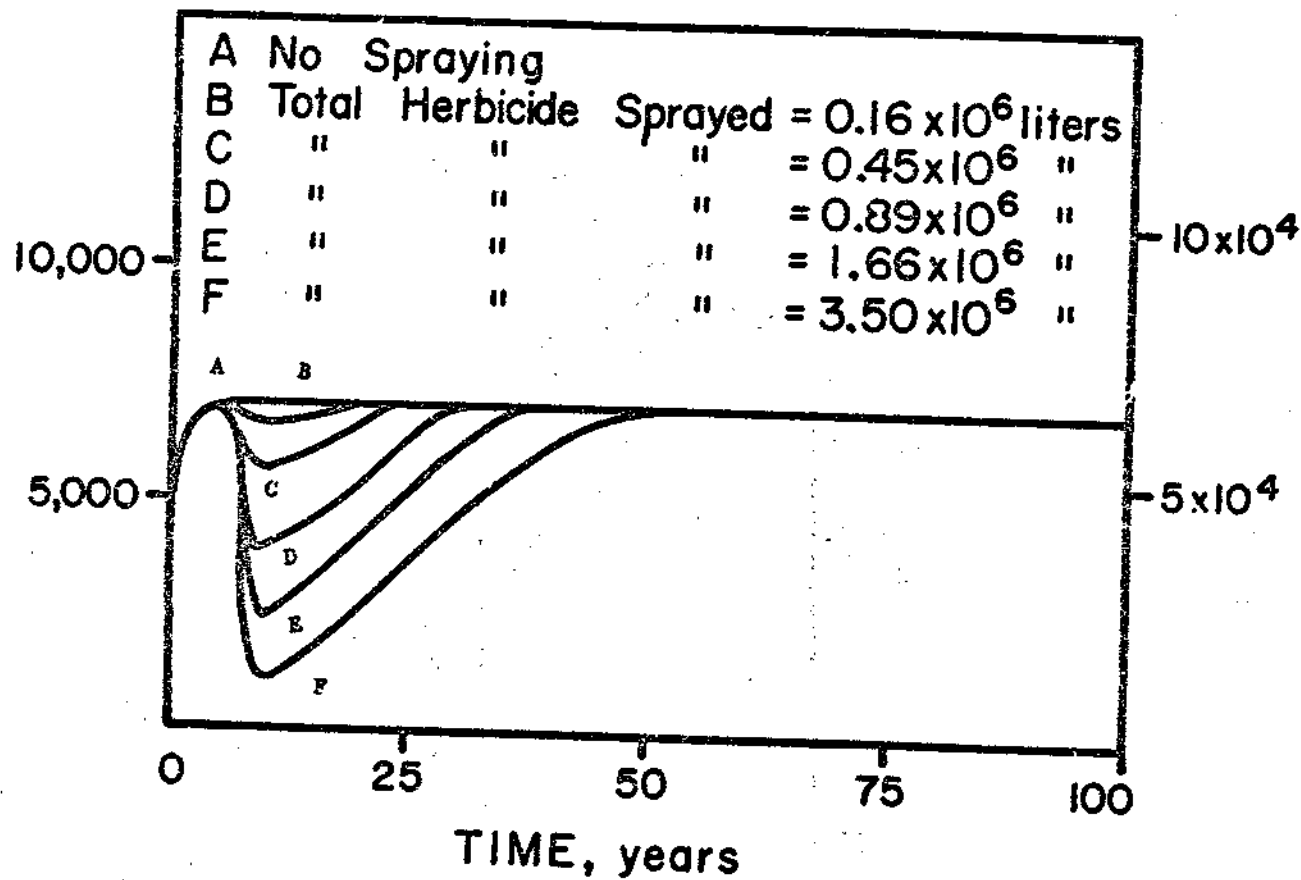

Figure 12a

MANGROVE BIOMASS,
grams per m²



Pounds per acre

Figure 12b

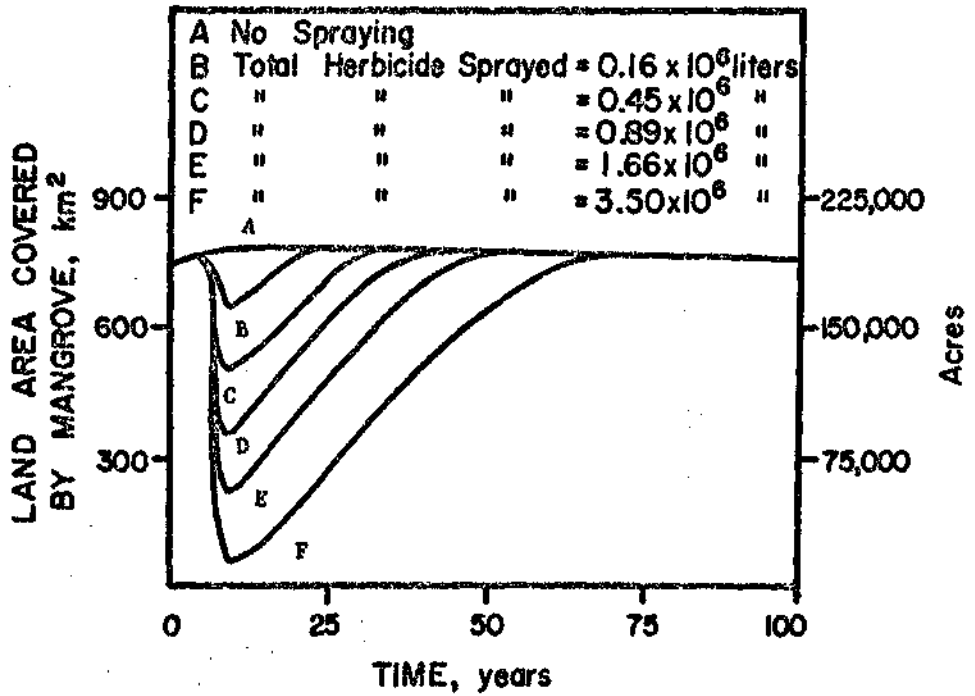
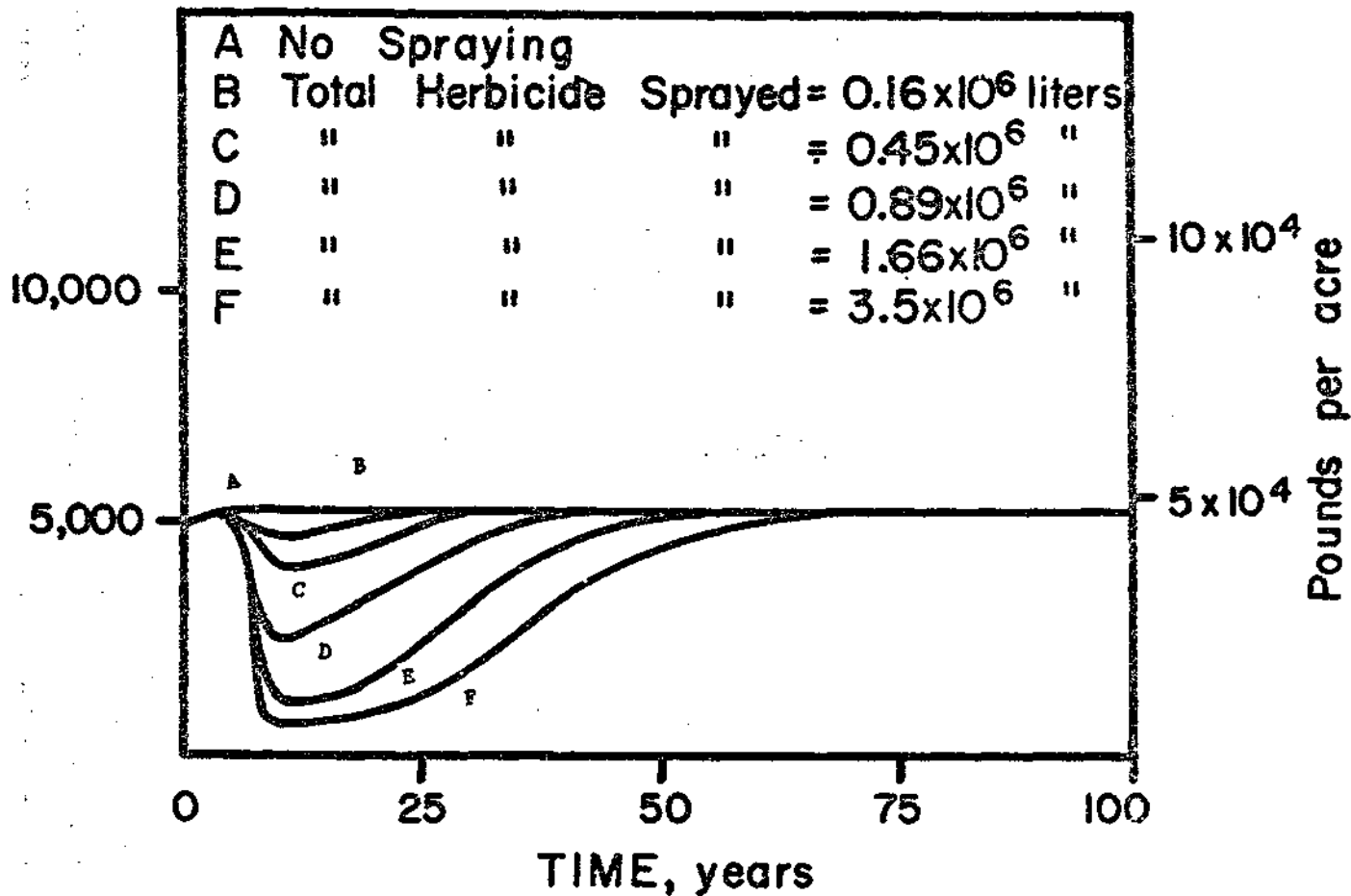

Figure 13a

MANGROVE BIOMASS,
grams per m²

Figure 13b



The times required for the mangroves to return to the prespraying biomass were 15, 25, 35, 50, or 60 years.

Figure 14 shows the effect of seedling availability on the rate of recolonization when the level of herbicide dosage was 3.5 million liters and the rate of gross photosynthesis was 14 gms per m^2 per day. The time required for recolonization by the mangroves was 40, 70, or 100 years for seedlings available all year, 6 or 3 months out of each year. As the availability of seedlings is decreased, then the time to reach a steady state level of mangrove biomass is increased.

Figures 15a, 15b, 15c show the effect of artificial planting of seedlings on the recolonization by mangroves. Each figure gives two planting rates of 15 to 75 seedlings per acre per year in addition to natural recolonization. In Figure 15a the rate of gross photosynthesis is 7 gms per m^2 per day and the cutting rate is 3% of the trees per year. Under these conditions and no additional planting by man, recolonization occurs in about 80 years. At a successful planting rate of 15 seedlings per acre the mangroves recolonize in 35 years and in 12 years at a successful planting rate of 75 seedlings per acre. Success in planting is 10% of the seedlings planted.

In Figure 15b the rate of gross photosynthesis is 14 gms per m^2 per day and cutting is 3% of the trees per year. These conditions and no additional planting by man result in recolonization by the mangroves in 40 years. At successful planting rates of 15 and 75 seedlings per acre per year, times for recolonization were 25 and 12 years.

In Figure 15c the rate of gross photosynthesis is 14 gms per day and the cutting rate has been increased to 30% of the trees per year. These conditions and no additional planting by man result in recolonization by the mangroves in 60 years. At successful planting rates of 15 and 75 seedlings per acre per year the times for recolonization were 30 and 12 years.

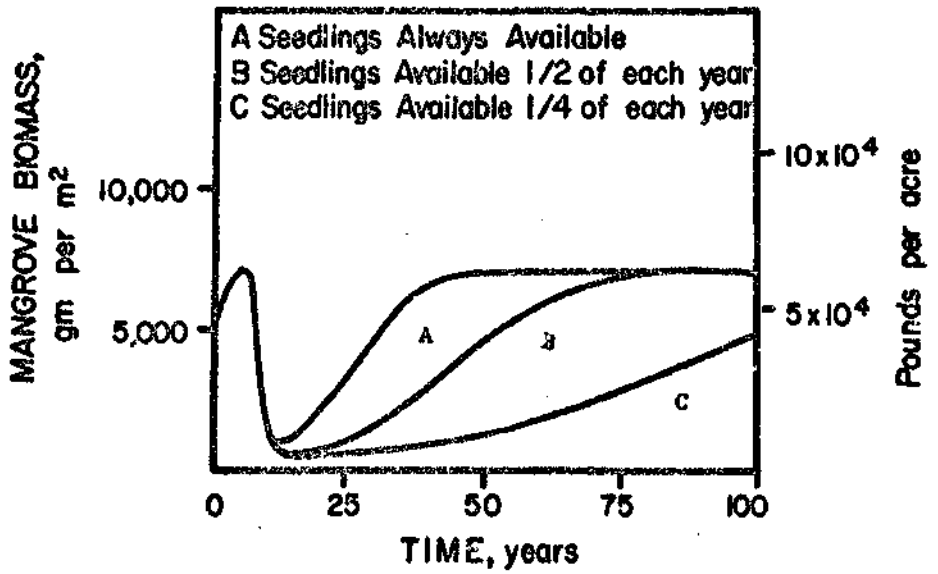

Figure 14

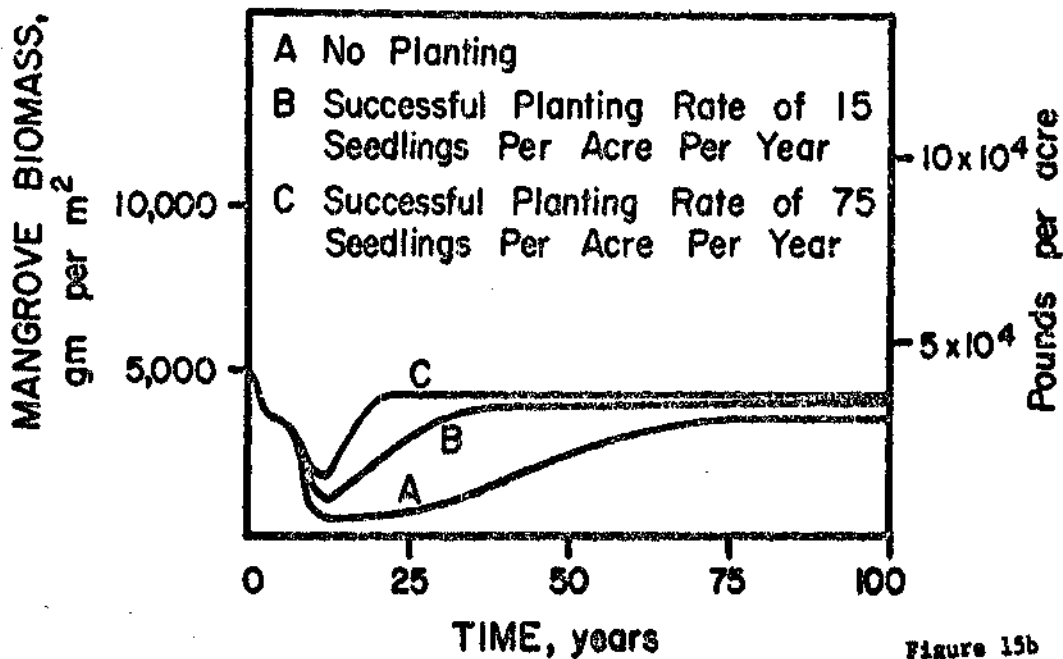

Figure 15b

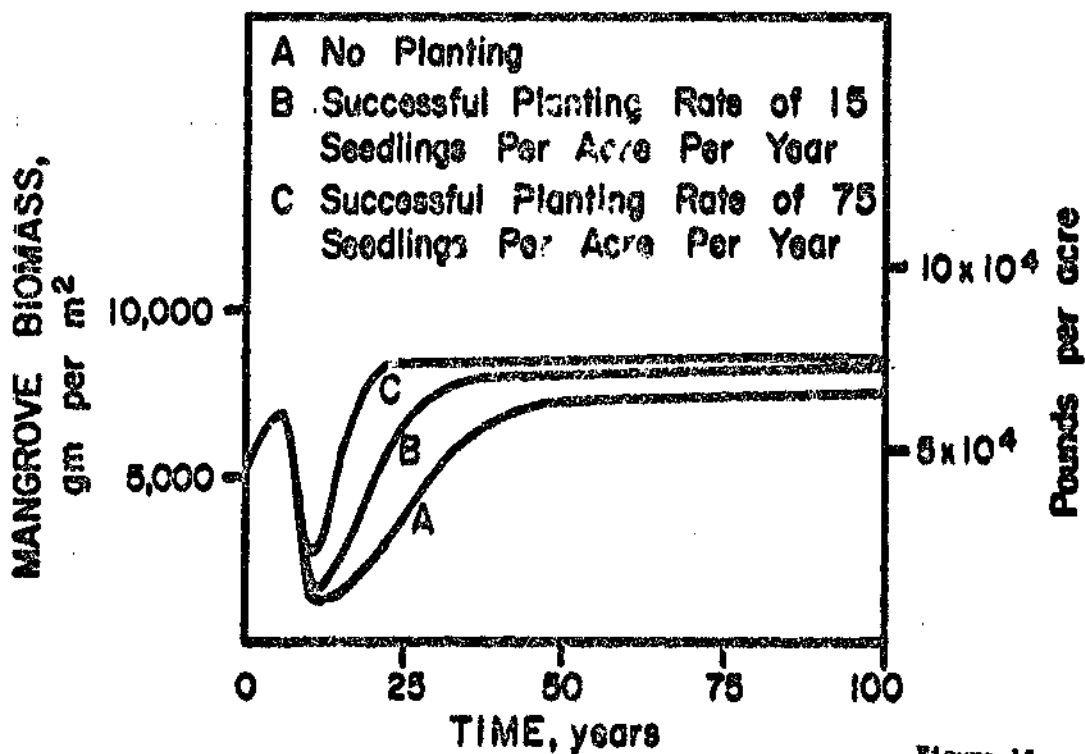

Figure 15a

MANGROVE BIOMASS,

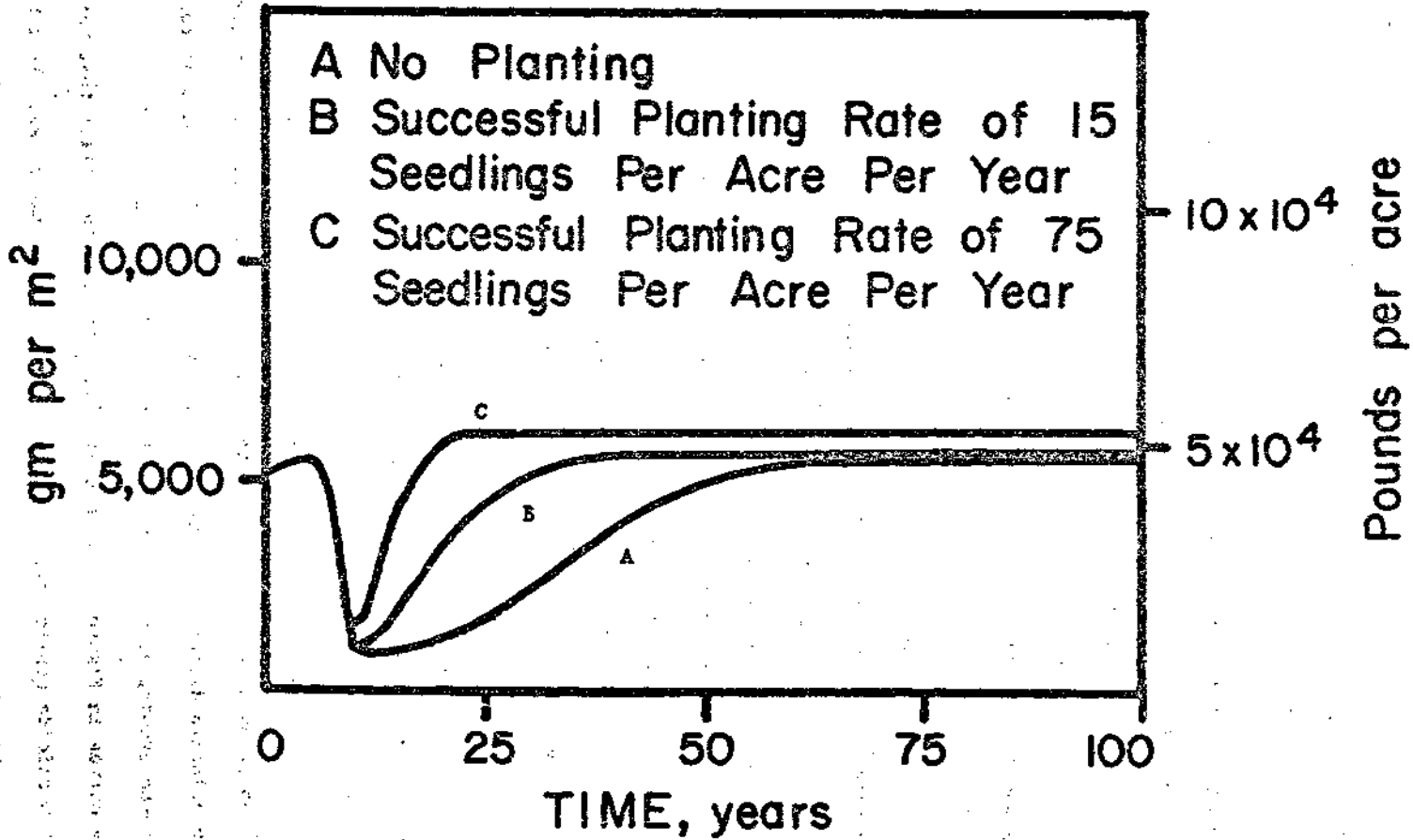

Figure 15c

DISCUSSION

An important factor that may influence the size of a mangrove forest is the availability of nutrients. In Figure 7 the several different rates of photosynthesis represent cases of different nutrient availability. The curves in this figure demonstrate that in conditions of plentiful nutrients the mangroves are healthy and form large trees. If nutrients are scarce, then the mangroves are low in biomass. This would tend to support observations that the largest mangroves tend to grow along the banks of tidal rivers where the currents constantly bring nutrients to the trees. The biomass values at steady state are relatively low compared to some values that have appeared in the literature. Colley (1968) reports a standing crop of 28,000 grams per square meter for mangroves in Panama and Lugo and Suedaker report biomass values ranging from 8700-13,400 grams per square meter for mangroves in Florida. For Thailand, Banijbatana (1957) reports yields for mangroves of 10,000 grams per square meter. Also, the value used in this simulation was 5000 grams per square meter from the study by Colley et al (1962) in Puerto Rico.

The low values may have also resulted from choosing a rate of respiration that was too high. If respiration is very high, then the rate of net production will be low. The effect of this is to give the low biomass values shown in Figure

7. The low biomass values could represent areas of mangroves in the Rung Sat such as those areas colonized by species of Carriops, a bush-type mangrove that can colonize disturbed areas. The higher biomass values would correspond to mangroves growing along the banks of the tidal channels.

The curves in Figure 9 were simulated to show the effect that varying rates of herbicide application may have on the Rung Sat mangroves. From Figures

10 - 13 this effect can be easily noted. The circles in Figure 9 indicate the herbicide levels that actually occurred during each of the years

from 1965 to 1970. Curve A in Figure 9 is the closest approximation to the actual spraying conditions. The total amount of herbicide sprayed on the mangroves of the Rung Sat was 3.9 million liters which compares with the 3.5 million liters of Curve A in Figure 9. For this reason the discussion will be involved with this rate of herbicide application.

At this high level of spraying and a rate of gross photosynthesis of 3.5 gms per m^2 per day (Figure 10a) the area of bare land produced was 725 km^2 or 72,500 hectares. Therefore, the amount of spraying was 48.3 liters per hectare or 5.05 gallons per acre. This corresponds roughly with the stated application rate of 3 gallons per acre. Under better nutrient conditions (Figure 11a) the area of bare land produced was 675 km^2 . The herbicide application rate in this case was 51.9 liters per hectare. Under possibly nutrient-rich conditions (Figure 12a) the area of bare land produced was 670 km^2 for an application rate of 52.3 liters per hectare. Since the application rate is greater than 3 gallons per acre (28.7 liters per hectare), this probably means that many areas were sprayed more than once.

Figures 10a, 11a and 12a show that the rate of recolonization can depend quite strongly on the level of nutrients available. If nutrients are a problem as in Figure 10a, then the mangroves take over 100 years to reach prespraying land areas. In addition the mangroves that do become established are low in biomass per m^2 (Figure 10b). With no nutrient problem, (Figure 12b) the mangroves recolonize the sprayed areas in years and reach reasonable level of biomass (Figure 12b).

Woodcutters were also shown to have an impact on the rate of recovery of mangroves. The bare land was colonized in 60 years at a cutting rate of 3% (Figure 12a) and in 65 years at a cutting rate of 30% of the trees (Figure 13a). Thus a tenfold increase in cutting rate delays the recovery only 5 years, but the biomass is lowered by 1600 gms per m^2 (7000 gms per m^2 in Figure 12b and 5400 gms

per m^2 in Figure 13b). An interesting outcome of these results is that the resulting mangroves would probably be undesirable for use as charcoal. The highly prized trees would be continually selected against by the woodcutters and the poorer valued trees would proliferate.

If the results of these simulations are correct, then both woodcutters and nutrient availability could act to delay the recovery of the mangroves of the Rung Sat. The need arises here for data on the level of nutrients in various sections of the Rung Sat. Also, at what rate are the woodcutters harvesting the remaining live mangrove trees?

Another variable that could very easily be the most important single factor limiting the recovery of the mangroves is the availability of seedlings to colonize the bare areas. Figure 14 shows very positively that if seedlings are only available two months during each year then recovery rates are extremely slow. Recently, E. B. Knippling of the University of Florida and others returned from Vietnam with photographs of the sprayed areas. These photographs support the hypothesis that lack of seedlings is the primary reason the bare areas are not being colonized by mangroves. In these photographs the seedling density was estimated to be one seedling per $62m^2$ of land. When one studies the photographs, it becomes quite apparent that seedlings are not reaching these areas with any regularity. Even areas flushed regularly by the tides contain very few seedlings. Some seedlings are present, however. What is the source for these seedlings?

If seedling scarcity is the primary reason for the very slow recovery of mangroves, then one alternative might be to plant seedlings. Figures 15a-c, show that planting seedlings will speed recovery. If lack of seedlings is the only problem, then a mangrove forest of adequate biomass is possible very quickly by artificial planting as shown in Figure 15b. If nutrients or woodcutters are the limiting factor, then planting will speed up recovery, but the steady-state biomass levels are low.

VALIDATION OF SIMULATION RESULTS AND DATA USED

Validation of the data used in the model has been difficult because of the war in South Vietnam. However, several people on the Committee have made trips to South Vietnam for onsite investigations. Golley made several counts of the density of seedlings. He found the seedling density in the water to be .02 seedlings m^{-2} in the sprayed area. Golley also counted a density of 46 seedlings per m^2 along the banks and levees. Farther away from tidal influence, the seedlings density was only .03 seedlings m^{-2} . Teas counted the number of seedlings on trees of Cerriops sp. and found a range of 364 to 586 seedlings per tree. Knipling and Weatherspoon took many photographs from ground level of the Rung Sat. From these photographs the area of land in each photograph was calculated and the number of seedlings counted to give only 1 seedling per $62m^2$. In Puerto Rico the seedling density ranged from 7-35 seedlings m^{-2} .

More detailed analysis of maps for the Rung Sat (see Ross's text) have revealed that the total area, including water, is $1050 km^2$ of which 23% is water. This would give $242 km^2$ of water area as compared to $250 km^2$ used for the simulation. The detailed analysis also revealed that only 51% of the land area was in mangroves prior to spraying. This gives an area of $535 km^2$ as compared to $700 km^2$ used in the simulation. A more detailed analysis also came up with $600 km^2$ as the area sprayed as compared to 525 for the simulation.

REFERENCES

- Banjibatar, D., "Mangrove Forest in Thailand", Proceedings Ninth Pacific Science Congress, Pacific Science Assoc. 22-34. 1957.
- Golley, F. B. Mineral Cycling in Tropical Forest Ecosystems. Institute of Ecology. University of Georgia. 1968.
- Golley, F. B., H. T. Odum, and R. P. Wilson. The Structure and Metabolism of a Puerto Rican Red Mangrove Forest in May. Ecology 43, 9-19. 1962.
- Lugo, A. and S. C. Snedaker. The Role of Mangrove Ecosystems in the Maintenance of Environmental Quality and a High Productivity of Desirable Fisheries. Progress Report to Bureau of Sport Fisheries and Wildlife. 1972.
- Lugo, A., M. G. Sell, and S. C. Snedaker. Mangrove Ecosystem Analysis. Presented at the Modelling Conference at the University of Georgia. 1973.
- Minarik, C. L. and A. L. Bertram. Evaluation of Camau Peninsula Defoliation Targets of 9 November 1962 in Republic of Vietnam. U.S. Army Biological Laboratories Report. 1962.
- Van Cuong, H. Flora et Vegetation de la Mangrove de la Region de Saigon-Cap Saint Jacques, Sud Vietnam. 1964.
- Yearly Weather Summary for Saigon 1964-1967 Directorate of Meteorology. Republic of Vietnam.

LIST OF FIGURES

1. Map of the Rung Sat zone southeast of Saigon
2. Model of the mangrove community in the Rung Sat zone of South Vietnam showing the important storages, forcing functions, and pathways
3. Model of mangrove forest in the Rung Sat zone of Vietnam with numerical values for the state variables and selected pathways
4. Annual variation in solar radiation (kilocalories per m^2 per day) for Saigon, Vietnam during the period January 1964 to October 1967
5. Model of mangrove forest in the Rung Sat zone of Vietnam showing the equations for each pathway of interest
6. Analog computer circuit diagram of the model of the mangrove forest in the Rung Sat zone of Vietnam
7. Steady state levels of mangrove biomass attained by the Rung Sat mangrove forest in Vietnam at four rates of gross photosynthesis (cutting rate equals 3% of the trees per year and initial biomass equals 5000 gm per m^2)
8. Effect of cutting on the mangrove forest of the Rung Sat in Vietnam (a) Rate of gross photosynthesis equals 14 gms per m^2 per day (b) Rate of gross photosynthesis equals 7 gms per m^2 per day
9. Variation of selected herbicide application rates during a five year period of spraying
10. Effect of herbicide spraying on (a) mangrove land and (b) mangrove biomass in the Rung Sat area of Vietnam (wood-cutting rate equals 3% of the trees per year and rate of gross photosynthesis equals 3.5 gms per m^2 per day)
11. Effect of herbicide spraying on (a) mangrove land and (b) mangrove biomass in the Rung Sat area of Vietnam (woodcutting rate equals 3% of the trees per year and rate of gross photosynthesis equals 7 gms per m^2 per day)

12. Effect of herbicide spraying on (a) mangrove land and (b) mangrove biomass in the Rung Sat area of Vietnam (wood-cutting rate equals 3% of the trees per year and rate of gross photosynthesis equals 14 gms per m² per day)
13. Effect of herbicide spraying on (a) mangrove land and (b) mangrove biomass in the Rung Sat area of Vietnam (wood-cutting rate equals 30% of the trees per year and rate of gross photosynthesis equals 14 gms per m² per day)
14. Effect of seedling availability on the rate of recolonization by the mangroves of the Rung Sat in Vietnam (wood-cutting rate equals 14 gms per m² per day and total herbicide applied equals 3.5 million liters or an average of 48.3 liters per hectare)
15. Effect of seedling planting by man on the recolonization by the mangroves of the Rung Sat in Vietnam (a) Wood-cutting rate equals 3% of the trees per year, rate of gross photosynthesis equals 7 gm per m² per day and total herbicide applied equals 3.5 million liters; (b) same as (a) except that the rate of gross photosynthesis is 14 gms per m² per day; (c) same as (a) except that the wood-cutting rate is 30% of the trees per year and rate of gross photosynthesis is 14 gms per m² per day.

LIST OF TABLES

1. Monthly solar radiation data for Saigon from January 1964 to October 1967 (units of Kcal per m^2 per day).
2. Description and quantification of the forcing functions, state variables and flow processes between state variables or between state variables and forcing functions that are given in Figure 3.
3. Calculation of rate coefficients for the pathways that occur in the mangrove model (Figure 3).
4. Values used for rate coefficients of pathways in model (Figure 3).
5. Differential equations that describe the state variables appearing in the model (Figure 5).
6. Scaled equations for use in the simulation.

4. Nutrient Models and Perspective on Mangrove Recovery in Rung Sat

Joan Browder, T. Ahlstrom, and M. Sell

After the trees of the Rung Sat were killed by herbicides, their leaves and wood were almost entirely removed by wood-cutters, tidal action, or decomposition, with a loss of nutrient content. Models that summarize the orders of magnitude of nutrients such as nitrogen and phosphorus per area of land are useful for providing some perspective on the fraction of nutrients remaining in muds, roots, and water. By comparing the stocks present and those removed with the rates of flow it is possible to gain some idea of the approximate time required for nutrient restoration. Preliminary models for nitrogen and phosphorus are given in Figure 1. Details of the bases for estimates shown in the energy diagrams are presented in Tables 1 and 2. More detailed data are being developed in another subcontract by P. Zinke, and additional diagrams and more precise numbers for compartments and flow rates can be added when totals are available from that work.

The models are drawn in energy language with some of the main driving functions shown but highly simplified. Notice that the phosphorus model has a higher percentage of total supply in leaves and wood than does the nitrogen model. There is an apparent stockpile of nitrogen in the mud. Therefore phosphorus may be the more limiting of the two nutrients in terms of regrowth.

The estimates of river inflow are very rough approximations, pending receipt of better data. If the magnitude assumed is correct, the Rung Sat obtains more than enough phosphorus to supply nutrient needs for regrowth. Even if the order of magnitude were less by a

factor of 100 there would still be enough. Because of the river situation, the models suggest that nutrients are not limiting. However calculations imply that soil organisms such as algae and bacteria may play an important role in incorporating nutrients from the river into the mud, thus making them available to mangrove roots. Exchange of nutrient-rich water with the mud is limited by the extremely low rate of water penetration due to permanently water-logged conditions (Clarke and Hannon, 1967). The ability of mangrove soils to supply nutrients for the reestablishment of mangrove vegetation in the Rung Sat may be greatly dependent upon the status of soil organisms in the period following herbicide application. In Fig. 2 is the model that has some main aspects of coupling of nitrogen and phosphorus.

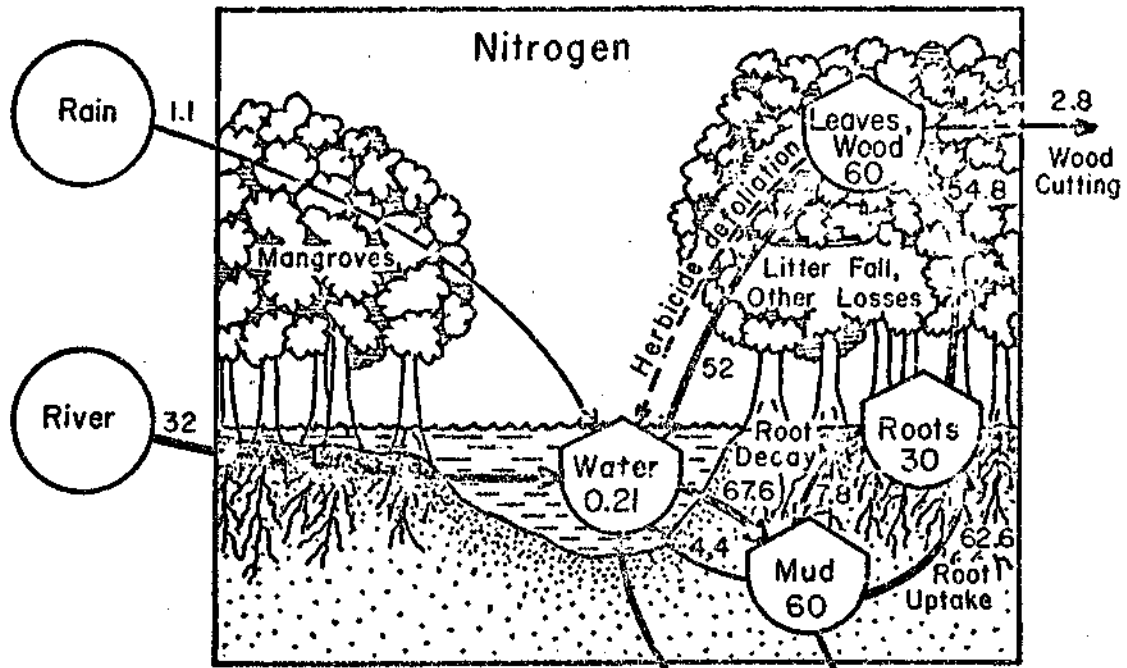

—▶ Rates in g/m²/yr
 Quantities in g/m²

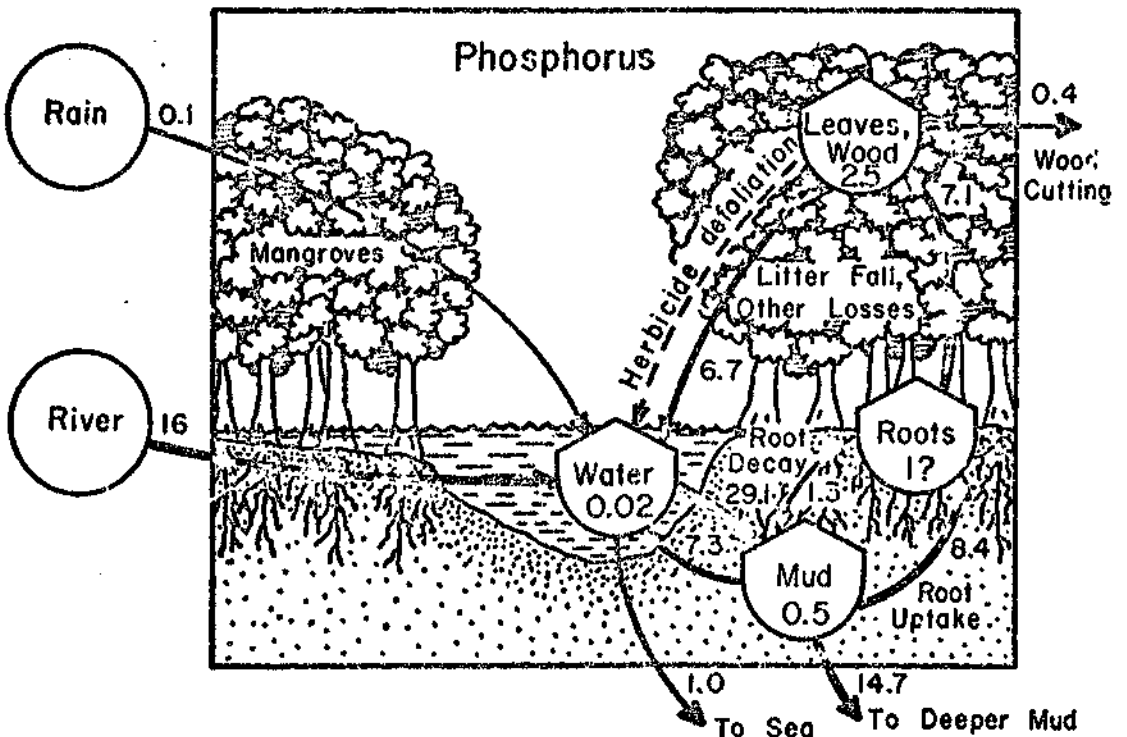

Fig. 1. Summary of nutrient cycles in mangroves forests of the Rung Sat.

Table 1. Basis for calculation of nitrogen stocks and flow rates. Numbers in parenthesis relate to compartments and pathways in Figure 51.

Explanation	Equation
<p>(1) Rate of incorporation into above-ground biomass This is a function of the rate of photosynthesis. Lugo, Sell, and Snedaker (unpub.) found that, in the mangroves on the west coast of Florida, rate of photosynthesis was approximately 10.72 grams Carbon/m² day. The ratio of nitrogen to carbon taken into the tree must be roughly equal to the ratio of nitrogen to carbon in the total biomass of the tree. Golley's (1968) value for nitrogen of 0.7 percent organic matter was divided by the amount of carbon in organic matter (approximately 0.5) to determine the ratio of nitrogen to carbon.</p>	$(10.72 \text{ gC/m}^2 \cdot \text{Day}) (.007 \text{ gN/1g OM})$ $(1 \text{g OM}/.5 \text{g C}) = (.15 \text{ g N/m}^2 \cdot \text{day})$ $(365 \text{ days/year}) = 54.75 \text{g N/m}^2 \cdot \text{yr.}$
<p>(2) Export of nitrogen by woodcutters Stands of mangroves in Vietnam are generally cutover about once every twenty years, so the removal rate is approximately 5 percent of the rate of photosynthesis. The ratio of nitrogen to organic matter in mangrove wood is approximately the same as that for the overall tree, 0.7 percent. The ratio of carbon to organic matter is 50 percent.</p>	$(10.72 \text{g C/m}^2 \cdot \text{day}) (0.5)$ $(.007 \text{g N/1 g OM}) (1 \text{g OM}/.5 \text{g C}) =$ $(0.0075 \text{g N/m}^2 \cdot \text{day}) (365 \text{ days/year}) =$ $2.92 \text{g N/m}^2 \cdot \text{yr.}$
<p>(3) Miscellaneous loss of nitrogen from biomass In a steady state system the rate of outflows should roughly equal rate of inflows. Nitrogen loss may occur through transpiration and unknown mechanisms as well as by leaf and wood fall and wood removal. The flow rate for miscellaneous nitrogen loss is calculated as follows:</p>	$(.15 \text{g N/m}^2 \cdot \text{day}) - (.048 \text{g N/m}^2 \cdot \text{day}) =$ $\text{incorporation leaf \& wood fall}$ $(.008 \text{g N/m}^2 \cdot \text{day}) (0.094 \text{g N/m}^2 \cdot \text{day})$ $(365 \text{ days/yr.}) = 34.31 \text{g N/m}^2 \cdot \text{day}$
<p>(4) Rate of nitrogen contribution to water pool by leaves, wood, and miscellaneous material falling from mangrove trees Heald¹ (1971) showed that 2.4 grams organic matter/m² day fell from mangroves in a riverine forest in south Florida. This value multiplied by the amount of carbon per gram organic</p>	$(2.4 \text{g OM/m}^2 \cdot \text{day}) (.5 \text{g C/1g OM})$ $(.02 \text{g N/g OM}) (1 \text{g OM}/.5 \text{g C})$ $(0.048 \text{g N/m}^2 \cdot \text{day}) (365 \text{ days/yr.}) =$ $17.52 \text{g N/m}^2 \cdot \text{yr.}$

Table -1. Continued

Explanation	Equation
<p>matter (.5g C/1g OM) gives the amount of carbon entering the water pool from this source each day. This is multiplied by the amount of nitrogen per gram carbon to give grams nitrogen/m²-day entering the water pool. Golley found that the ratio of nitrogen to organic matter in the leaves of Panamanian tropical forest trees, including mangroves, was higher than that in overall biomass--2.0 percent.</p>	
<p>(5)Rate of nitrogen entry into the Rung Sat water pool from rainfall</p>	(7.0kg N/ha) (1000g/kg)
<p>The amount of nitrogen contributed to the water pool of Rung Sat by rainfall was estimated from values for Lake County, Fla., reported by Snedaker and Poole (1972), which was 7.0kg/hectare:yr. Rainfall in the Lake County area is approximately 50 in/yr., while that in the Rung Sat is about 80 in/yr., so the value for Lake County was adjusted to the area of greater rainfall by multiplying by 1.6 (80/50).</p>	$(1 \text{ ha}/10,000 \text{ m}^2) (1.6) =$ $1.095 \text{ g N/m}^2 \cdot \text{year}$
<p>(6)Flow of nitrogen from the Saigon River into the water pool of the Rung Sat</p>	
<p>The flow of the Saigon River at a point immediately below Saigon and above entry into the Rung Sat is 60-90 meters/min. (an average value of 75 meters/min. was used in calculations). This amounts to 75(60 min/hr) (24 hr/day)=1.08x10⁵ meters/day. This value was doubled because one other river also flows across the Rung Sat. The width of the Saigon River at the point measured is approximately 400 meters. The depth of the river at that point was approximately 12 meters. By multiplying the meter flow per day by the depth of the river and the width of the river, the total amount of river water flowing over the Rung Sat was estimated. The total area of the Rung Sat is 700 km²=7x10⁸ m². This value divided into the total amount of river water entering the Rung Sat provides an average amount of river water flowing across the average meter square of Rung Sat substrate each day. The concentration of nitrogen in the river is approximately equal to that</p>	$2(400 \text{ m}) (12 \text{ m}) (1.08 \times 10^5 \text{ m/day})$ $(1/7 \times 10^8 \text{ m}^2) (2 \text{ g N/m}^3) =$ $(2.96 \text{ g N/m}^2 \cdot \text{day}) (365 \text{ days/yr.}) =$ $1090.4 \text{ g N/m}^2 \cdot \text{year}$

Table 1. Continued

Explanation	Equation
of any other large river that receives sewage from a large city. This value is approximately 2 g/m^2 (Odum, pers. comm.)	
(7) Export of nitrogen from a mangrove swamp as detritus and river runoff This is a two way flow because there is always some amount ($.14 \text{ g/m}^2 \cdot \text{day}$) of nitrogen entering the swamp from the sea. The flow in the other direction is greater, however, for the combined action of river flow and tidal flux carries out to the estuary 13.4 percent of the gross photosynthesis (detritus from leaf, wood, and miscellaneous fall) and all the nitrogen from the river that is not absorbed into the mud with soil water.	$(.003 \text{g N/m}^2 \cdot \text{day}) + (2.96 \text{g N/m}^2 \cdot \text{day}) +$ <p style="text-align: center;">from rain from river</p> $(.048 \text{g N/m}^2 \cdot \text{day}) + (.005 \text{g N/m}^2 \cdot \text{day}) -$ <p style="text-align: center;">from detritus from mud</p> $(.0279 \text{g N/m}^2 \cdot \text{day}) = 2.988 \text{g N/m}^2 \cdot \text{day} =$ <p>concentration of nitrogen in the water pool without export to sea</p> $(2.988 \text{g N/m}^2 \cdot \text{day}) - (0.21 \text{g N/m}^2 \cdot \text{day}) =$ $(2.777 \text{g N/m}^2 \cdot \text{day})(365 \text{ days/yr.}) =$ $1013.61 \text{g N/m}^2 \cdot \text{year}$
(8) Movement of nitrogen from water pool into mangrove mud Calculations based on data from Clarke and Hannon (1967) indicate that the rate of water penetration into mangrove soils varies from approximately 1 to 10 centimeters per day, depending on the number of crabholes the soil contains. The slow rate of water movement is due to the almost consistently water-logged state of these soils, which are located almost entirely in the intertidal zone. The presence of burrows maintained by <i>Uca</i> and other crabs increases the rate of water penetration about tenfold.	
The amount of water from the water pool that can be absorbed into one square meter of mangrove mud each day can be estimated as follows:	
Absence of crabholes: $(.01 \text{m})(1 \text{m}^2) = 0.01 \text{ m}^3 \text{ water/m}^2 \cdot \text{day}$	
Proximity to crabholes: $(.1 \text{m})(1 \text{m}^2) = .1 \text{ m}^3 \text{ water/m}^2 \cdot \text{day}$	
The flow of nitrogen into the water pool from the river and the sea is approximately $1.55 \text{ g/m}^2 \cdot \text{day}$, assuming an average depth of one meter over the entire Rung Sat	$(0.155 \text{g N/m}^2 \cdot \text{day}) = (0.026 \text{g N/m}^2 \cdot \text{day}) =$ $(0.183 \text{g N/m}^2 \cdot \text{day})(365 \text{ days/yr.}) =$ $62.05 \text{g N/m}^2 \cdot \text{year}$

Table 1. Continued

Explanation	Equation
<p>and that river water and sea water are, on the average, mixing in a 1:1 ratio. If this mixture is absorbed into one meter square of substrate per day according to the above variation then the flow of nitrogen into the substrate varies also, as follows:</p>	
<p>Without crabholes: $(.01 \text{ m}^3 \text{ water/m}^2 \text{ area})(1.55 \text{ g N/m}^3 \text{ water} \cdot \text{day}) = 0.0155 \text{ g N/m}^2 \cdot \text{day}$</p>	
<p>With crabholes: $(.1 \text{ m}^3 \text{ water/m}^2 \text{ area})(1.55 \text{ g N/m}^3 \text{ water} \cdot \text{day}) = 0.155 \text{ g N/m}^2 \cdot \text{day}$</p>	
<p>Enough nitrogen must move into the soil to replace the 0.15 g/m²·day of nitrogen being used in photosynthesis. If the concentration of nitrogen in the soil is as high (400-800 g/m²) as estimated by Zinke even more nitrogen may be moving into the soil than is taken up by the trees. Other methods of nitrogen absorption maybe operating. Perhaps algae, bacteria, and filter-feeding organisms on prop roots and at the surface of the mud are actively taking in nitrogen, concentrating it in their tissues, and releasing it in excrement and with death. A nitrogen concentration of 400-800 g/m² in the soil compared to 0.21 g/m² (assuming 1 m depth) in the water pool suggests that an effective means of removing nitrogen from the water and holding it in the soil must be operating. In addition, nitrogen measurements are needed on this aspect of the problem of nutrient cycling in mangroves.</p>	
<p>Meanwhile, the flow of nitrogen from the water pool to the mud has been set at 0.183 g N/m²·day to allow for enough nitrogen to meet the requirements of the rate of photosynthesis by mangrove trees plus some excess to allow for low rates of nitrogen loss into the deep mud and back to the water pool.</p>	
<p>(9) Nitrogen flow from surface soils to deep mud The concentration of nitrogen in deep muds suggested by Zinke is very high compared to that of the surface muds (see last entry in this table). The soils on which the mangroves were growing may have accumulated over a bed of nitrogenous peat, or leaching of nitrogen into deep soils may be taking place. The rate of leaching</p>	$.183 \text{ gN/m}^2 \cdot \text{day} + .020 \text{ g N/m}^2 \cdot \text{day} -$ <p style="text-align: center;">from water pool from roots</p> $.170 \text{ g N/m}^2 \cdot \text{day} - .005 \text{ g N/m}^2 \cdot \text{day} =$ <p style="text-align: center;">to roots to water pool</p>
	$.028 \text{ g N/m}^2 \cdot \text{day} \times 365 = 10.22 \text{ gN/m}^2 \cdot \text{yr}$

Table 1. Continued

Explanation	Equation
to deep muds can be approximated for a steady-state system.	
(10) Rate of loss of nitrogen from mud to water pool Loss to the water pool is probably less than the loss to deep soils, since the deep muds have such a high concentration as reported by Zinke. This was assumed to be the case and the flow rate was calculated for a steady-state system.	$.193 \text{ g N/m}^2 \cdot \text{day} + .020 \text{ g N/m}^2 \cdot \text{day} -$ <p style="text-align: center;">from water pool from roots</p> $.170 \text{ g N/m}^2 \cdot \text{day} - .023 \text{ g N/m}^2 \cdot \text{day} =$ <p style="text-align: center;">to roots to deep mud</p>
(11) Rate of uptake of nitrogen from mud by mangrove roots Nitrogen uptake from mud by the roots, like nitrogen incorporation into above-ground biomass, is a function of the rate of photosynthesis, which is approximately 10.72 g C/m ² ·day in South Florida (Lugo, Sell, and Snedaker, 1973). According to Golley (1968), the nitrogen content of roots of tropical trees is 0.3 percent of the organic matter, a value slightly greater than that of the overall tree. The ratio of carbon to organic matter is about 0.5.	$.005 \text{ gN/m}^2 \cdot \text{day} \times 365 = 1.825 \text{ g N/m}^2 \cdot \text{yr.}$ $(10.72 \text{ g C/m}^2 \cdot \text{day})(.008 \text{ g N/1g CM})$ $(1 \text{g CM}/.5 \text{ g C}) \times 1.699 \text{ g N/m}^2 \cdot \text{day}$ $(365 \text{ days/year}) = 62.05 \text{ g N/m}^2 \cdot \text{yr.}$
(12) Rate of nitrogen loss from roots to mud through root death and decay. In a mangrove forest in South Florida, Sell (pers. comm.) found that approximately 15% of the trees were dead. With the death of trees, roots gradually decay and release their store of nutrients back to the soil. Decomposition proceeds very slowly in water-logged mangrove soils, which are highly anaerobic; however, the fact that death is a continuous process means that some decay is always going on. If we assume that 15% of the roots in the soil are in a state of slow decomposition, then approximately 0.15 times the rate of uptake by the roots is being released to the soil.	$.15 (0.1699 \text{ g N/m}^2 \cdot \text{day}) =$ $(.020 \text{ g N/m}^2 \cdot \text{day})(365 \text{ days/year}) =$ $7.30 \text{ g N/m}^2 \cdot \text{yr.}$
(13) Pulse of herbicide application, increasing the rate of leaf fall and rate of wood removal by woodcutters until the supply is depleted. Trees are killed and the above-ground biomass is removed by woodcutters, tidal flux, and decomposition.	

Table 1. Continued

Exolanation	Equation	
(14) Nitrogen present in compartments, according to estimates by Zinke (pers. comm.).	Leaves and wood	60 g N/m ²
	Roots	30 g N/m ²
	water pool	.21 g N/m ²
	Mud	600 g N/m ²
	Deep mud	1700 g N/m ²

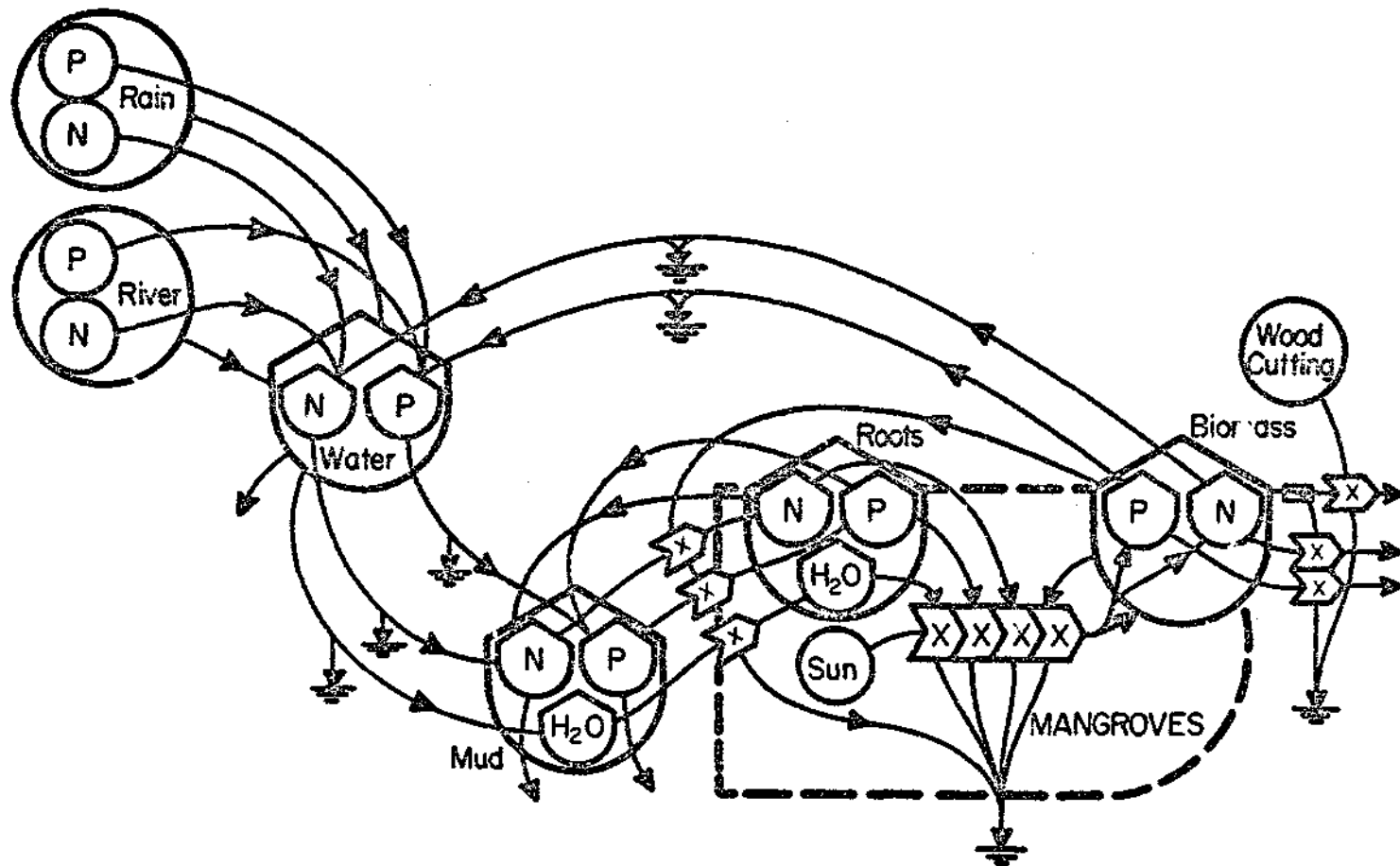

Figure 2.

Table 2. Basis for calculation of phosphorus stocks and flow rates. Numbers in parenthesis relate calculations to compartments and pathways in Fig. B2.

Explanation	Equation
<p>(1) Rate of incorporation into above-ground biomass</p> <p>This is a function of photosynthesis. Lugo, Sell, and Snedaker (1973) found that, in the mangroves on the west coast of Florida, rate of photosynthesis was approximately 10.72 grams Carbon/m²·day. The ratio of phosphorus to carbon taken into the tree is equal to the ratio of phosphorus to carbon in the total tree biomass. Colley's (1958) value for phosphorus of 0.09 percent organic matter was divided by the amount of carbon in organic matter (approximately 50 percent) to determine the ratio of phosphorus to carbon.</p>	$(10.72 \text{ g C/m}^2 \cdot \text{day})(.0009 \text{ g P/1 g OM})(1 \text{ g OM/.5 g C}) = 0.0193 \text{ g P/m}^2 \cdot \text{day} \times 365 = 7.05 \text{ g P/m}^2 \cdot \text{yr}$
<p>(2) Export by woodcutters</p> <p>Stands of mangroves in Vietnam are generally cutover about once every twenty years, so the removal rate is approximately 5 percent of the rate of incorporation through photosynthesis. The ratio of phosphorus to organic matter in mangrove wood is approximately the same as that for the overall tree, 0.09 percent. The ratio of carbon to organic matter is 50 percent.</p>	$(10.72 \text{ g C/m}^2 \cdot \text{day})(.05)(.0009 \text{ g P/1 g OM})(1 \text{ g OM/.5 g C}) = 0.001 \text{ g P/m}^2 \cdot \text{day} \times 365 = 0.365 \text{ g P/m}^2 \cdot \text{yr}$
<p>(3) Miscellaneous loss of phosphorus from biomass</p> <p>In a steady-state system the rate of outflows should roughly equal the rate of inflows. Phosphorus loss may occur through transpiration and unknown mechanisms as well as by leaf and wood fall and wood removal.</p>	$(.019 \text{ g P/m}^2 \cdot \text{day}) - (.003 \text{ g P/m}^2 \cdot \text{day}) - (.001 \text{ g P/m}^2 \cdot \text{day}) = \text{incorporation} \quad \text{leaf \& wood fall} \quad \text{woodcutters}$ $0.015 \text{ g P/m}^2 \cdot \text{day} \times 365 = 5.73 \text{ g P/m}^2 \cdot \text{yr}$
<p>(4) Rate of phosphorus contribution to water pool by leaves, wood, and miscellaneous material falling from trees</p> <p>Heald (1971) showed that 2.4 g organic matter/m²·day fell from mangroves in a riverine forest in south Florida.</p>	$(2.4 \text{ g OM/m}^2 \cdot \text{day})(.5 \text{ g C/1 g OM})(.0011 \text{ g P/g OM})(1 \text{ g OM/.5 g C}) = 0.003 \text{ g P/m}^2 \cdot \text{day} \times 365 = 0.95 \text{ g P/m}^2 \cdot \text{yr}$

Table 2. Continued, page 2

Explanation.	Equation
<p>This value multiplied by the amount of carbon per gram organic matter (.5 g C/1 g OM) gives the amount of carbon entering the water pool from this source each day. This is multiplied by the amount of phosphorus per gram carbon to give grams phosphorus/m²·day entering the water pool. Golley (1968) found that the ratio of phosphorus to organic matter in the leaves of Panamanian tropical forest trees, including mangroves, was 0.02 percent higher than that in overall biomass, so the value of 0.05 percent + 0.02 percent = 0.11 percent phosphorus was used in this calculation.</p>	
<p>(5) Rate of phosphorus entry into the Rung Sat water pool from rainfall</p>	$(.6 \text{ kg P/ha})(1000 \text{ g/kg})(1 \text{ ha}/10,000 \text{ m}^2)(1.6) = 0.1095 \text{ g P/m}^2 \cdot \text{yr}$
<p>The amount of phosphorus contributed to the water pool of the Rung Sat by rainfall was estimated from values for Lake County, Fla., reported by Snedaker and Poole (1972), which was 0.6 kg/hectare·yr. Rainfall in the Lake County area is about 80 in/yr, so the value for Lake County was adjusted to the area of greater rainfall by multiplying by 1.6 (80/50). The contribution of phosphorus by rainfall is very small compared to that from the sea and especially compared to that from the river.</p>	
<p>(6) Flow of phosphorus from the Saigon River into the water pool of the Rung Sat</p>	$2(400 \text{ m})(12 \text{ m})(1.08 \times 10^5 \text{ m/day})(1/7 \times 10^8 \text{ m}^2)(1 \text{ g P/m}^3) = 1.48 \text{ g P/m}^2 \cdot \text{day} \times 365 = 540.20 \text{ g P/m}^2 \cdot \text{yr}$
<p>The flow of the Saigon River at a point immediately below Saigon and above entry into the Rung Sat is 60-90 m/min (an average value of 75 m/min was used in calculation). This amounts to 75(60 min/hr)(24 hr/day) = 1.08 X 10⁵ m/day. This value was doubled because one other river also flows across the Rung Sat. The width of the Saigon River at the point measured is approximately 400 m. The depth at that point is approximately 12 m. By multiplying the meter flow per day by the depth of the river and the width of the river, the total amount of river water flowing over the Rung Sat was estimated. The total area of</p>	

Table 2. Continued, page 3

Explanation	Equation
<p>the Rung Sat is $700 \text{ km}^2 = 7 \times 10^8 \text{ m}^2$. This value divided into the total amount of river water entering the Rung Sat provides an average amount of river water flowing across the average meter square of Rung Sat substrate each day. The concentration of phosphorus in the river is approximately equal to that of any other large river that receives sewage from a large city. This value is approximately 1 g/m^3 (Odum, pers. comm.).</p>	
<p>(7) Rate of export of phosphorus as detritus and river runoff This is a two-way flow because there is always some amount ($0.02 \text{ g/m}^3 \cdot \text{day}$) of phosphorus entering the swamp from the sea. The flow in the other direction is greater, however, for the combined action of river flow and tidal flux carries out to the estuary 13.4 percent of the gross photosynthesis of the trees (detritus from leaf, wood, and miscellaneous fall) and all the phosphorus from the river that is not absorbed into the mud with soil water.</p>	$ \begin{aligned} & (.0003 \text{ g P/m}^2 \cdot \text{day}) + (1.48 \text{ g P/m}^2 \cdot \text{day}) + (.003 \text{ g P/m}^2 \cdot \text{day}) \\ & \quad \text{from rain} \qquad \qquad \qquad \text{from river} \qquad \qquad \qquad \text{from detritus} \\ & + (.0120 \text{ g P/m}^2 \cdot \text{day}) - (.0756 \text{ g P/m}^2 \cdot \text{day}) = \\ & \quad \text{from mud} \qquad \qquad \qquad \text{to mud} \\ & 1.419 \text{ g P/m}^2 \cdot \text{day} \times 365 = 518.04 \text{ g P/m}^2 \cdot \text{yr} \end{aligned} $
<p>(8) Rate of movement of phosphorus from water pool to mud Calculations based on data from Clarke and Hannon (1967) indicate that the rate of water penetration into mangrove soils varies from approximately 1 to 10 centimeters per day, depending on the number of crabholes the soil contains. The slow rate of water movement is due to the almost constantly water-logged state of these soils, which are located almost entirely in the intertidal zone. The presence of burrows maintained by <u>Uca</u> and other crabs increases the rate of water penetration about tenfold.</p>	<p>Absence of crabholes: $(.01 \text{ m})(1 \text{ m}^2) = 0.01 \text{ m}^3 \text{ water/m}^2 \cdot \text{day}$ Crabholes present: $(.1 \text{ m})(1 \text{ m}^2) = 0.1 \text{ m}^3 \text{ water/m}^2 \cdot \text{day}$</p>
<p>The flow of phosphorus into the water pool from the river and the sea is approximately $0.75 \text{ g/m}^2 \cdot \text{day}$, assuming an average depth of 1 meter over the entire Rung Sat and that river water and sea water are, on the average, mixing in a 1:1 ratio. If this mixture is absorbed into 1 m^2 of substrate per day according to the variation shown in the first two equations, then the flow of phosphorus into the</p>	<p>Without crabholes: $(.01 \text{ m}^3 \text{ w/m}^2)(.75 \text{ g P/m}^3 \text{ w} \cdot \text{day}) = 0.0075 \text{ g P/m}^2 \cdot \text{day}$ With crabholes: $(.1 \text{ m}^3 \text{ w/m}^2)(.75 \text{ g P/m}^3 \text{ w} \cdot \text{day}) = 0.075 \text{ g P/m}^2 \cdot \text{day}$</p>

Table 2. Continued , page 4

Explanation	Equation
<p>substrate varies also. The maximum rate appears on the energy diagram (Fig. B2). A family of curves based on flow rates ranging from the minimum to the maximum calculated can be achieved through analog simulation. The maximum rate provides an access of phosphorus relative to the rate of incorporation into biomass through photosynthesis. If Zinke's estimate of a surface soil concentration of 0.5 g P/m^3 is substantiated, then phosphorus accumulates very little in surface muds, leaching to deep muds or back to the water pool instead. Much more information is needed on the behavior of phosphorus in mangrove soils.</p>	$.075 \text{ g P/m}^2\cdot\text{day} \times 365 = 27.59 \text{ g P/m}^2\cdot\text{yr}$
<p>(9) Phosphorus flow from surface soils to deep mud The concentration of phosphorus in deep muds suggested by Zinke is very high compared to that of the surface muds (see last item in this table). The soils on which the mangroves were growing may have accumulated over a bed of phosphatic sediment, or leaching of phosphorus into deep soils may be taking place. The rate of leaching to deep muds can be approximated for a steady-state system.</p>	$\begin{aligned} &.08 \text{ g P/m}^2\cdot\text{day} + .0002 \text{ g P/m}^2\cdot\text{day} - .0195 \text{ g P/m}^2\cdot\text{day} \\ &\text{from water pool} \quad \text{from roots} \quad \text{to roots} \\ - .0120 \text{ g P/m}^2\cdot\text{day} &= 0.0443 \text{ g P/m}^2\cdot\text{day} \times 365 = 4.38 \text{ g P/m}^2\cdot\text{yr} \\ &\text{to water pool} \end{aligned}$
<p>(10) Rate of loss of phosphorus from mud to water pool Loss to the water pool is probably less than the loss to deep soils. This was assumed to be the case and a rate value was calculated for a steady-state system.</p>	$\begin{aligned} &.08 \text{ g P/m}^2\cdot\text{day} + .0002 \text{ g P/m}^2\cdot\text{day} - .0195 \text{ g P/m}^2\cdot\text{day} \\ &\text{from water pool} \quad \text{from roots} \quad \text{to roots} \\ - .0443 \text{ g P/m}^2\cdot\text{day} &= 0.012 \text{ g P/m}^2\cdot\text{day} \times 365 = 0.012 \text{ g P/m}^2\cdot\text{yr} \\ &\text{to deep soil} \end{aligned}$
<p>(11) Rate of uptake of phosphorus from mud by mangrove roots Phosphorus uptake from mud by roots, like phosphorus incorporation into above-ground biomass, is a function of the rate of photosynthesis, which is approximately 10.72 grams C per $\text{m}^2\cdot\text{day}$ in south Florida (Lugo, Sell, and Snedaker, 1973). The phosphorus content of mangrove roots is approximately 0.11 percent. The ratio of carbon to organic matter is about 50 percent.</p>	$\begin{aligned} &(10.72 \text{ g C/m}^2\cdot\text{day})(.0011 \text{ g P/1 g OM})(1 \text{ g OM/.5 g C}) = \\ &0.02 \text{ g P/m}^2\cdot\text{day} \times 365 = 7.12 \text{ g P/m}^2\cdot\text{yr} \end{aligned}$

Table 2. Continued, page 5

Explanation	Equation								
(12) Rate of phosphorus loss from roots to mud through root death and decay.	$.15(.0195 \text{ g P/m}^2\text{-day}) = 0.0002 \text{ g P/m}^2\text{-day} \times 365 = 0.07 \text{ g P/m}^2\text{-yr}$								
<p>In a mangrove forest in south Florida, Sell (pers. comm.) found that approximately 15 percent of the trees were dead. With the death of trees, roots gradually decay and release their store of nutrients back to the soil. Decomposition proceeds very slowly in water-logged mangrove soils, which are highly anaerobic; however the fact that death is a continuous process in the mangrove community means that some decay is always going on. If we assume that 15 percent of the roots in the soil are in a state of slow decomposition, then approximately 0.15 times the rate of uptake of phosphorus by roots is being released to the soil. The concentration of phosphorus in the soil is one half that in the roots, an entirely different case from that of nitrogen, where the concentration in the soil was several hundred times that in the roots.</p>									
(13) Pulse of herbicide application, increasing rate of leaf fall and rate of wood removal by woodcutters until the supply is depleted									
Trees are killed and the above-ground biomass is removed by woodcutters, tidal flux, and decomposition.									
(14) Phosphorus present in compartments, according to estimates by Zinke (pers. comm.)	<table> <tr> <td data-bbox="928 919 1130 943">Leaves and wood</td> <td data-bbox="1315 919 1453 943">2.5 g P/m²</td> </tr> <tr> <td data-bbox="928 958 996 981">Roots</td> <td data-bbox="1315 958 1453 981">1 g P/m²</td> </tr> <tr> <td data-bbox="928 996 969 1019">Mud</td> <td data-bbox="1315 996 1453 1019">0.5 g P/m²</td> </tr> <tr> <td data-bbox="928 1034 1064 1058">Water Pool</td> <td data-bbox="1315 1034 1465 1058">0.03 g P/m²</td> </tr> </table>	Leaves and wood	2.5 g P/m ²	Roots	1 g P/m ²	Mud	0.5 g P/m ²	Water Pool	0.03 g P/m ²
Leaves and wood	2.5 g P/m ²								
Roots	1 g P/m ²								
Mud	0.5 g P/m ²								
Water Pool	0.03 g P/m ²								

LITERATURE CITED

- Clarke, L.D. and N.J. Hannon. 1967. The mangrove swamp and salt marsh communities of the Sydney district. I. Vegetation, soils and climate. *J. Ecol.* 55: 753-771.
- Golley, F.B. 1968. Mineral cycling in tropical forest ecosystems. University of Florida Institute of Ecology. Athens, Georgia.
- Golley, F.B., H.T. Odum, and R.F. Wilson. 1962. The structure and metabolism of a Puerto Rican red mangrove forest in May. *Ecology* 43: 9-19.
- Heald, E.J. 1971. The production of organic detritus in a south Florida estuary. Sea Grant Tech. Bull. No. 6. University of Miami Sea Grant Program. Miami, Florida.
- Lugo, A.E., M.G. Sell, and S.C. Snedaker. 1973. Mangrove ecosystem analysis. Presented at the Systems Ecology Conference in March, 1973, at the University of Georgia. Athens, Georgia.
- Snedaker, S.C. and A.E. Lugo. 1972. The role of mangrove systems in the maintenance of environmental quality and high productivity of desirable fisheries. Progress Report to Bureau of Sport Fisheries and Wildlife. Center for Aquatic Sciences. University of Florida. Gainesville.
- Snedaker, S.C. and D. Poole. 1972. Water management and nutrient cycling at Wild Kingdom (Lake County, Florida).

5. DIGITAL SIMULATION OF POTENTIAL REFORESTATION PROBLEMS IN THE RUNG SAT
DELTA, VIET NAM

Philip C. Miller, James R. Ehleringer, Barry Hynum, and Wayne Stoner

Department of Biology
Center for Regional Environmental Problems
California State University, San Diego
San Diego, California 92115

INTRODUCTION

Between 1962 and 1969 about 5 million acres of forest land and crop land in Viet Nam were sprayed with herbicides. Agent orange, containing 2, 4-D and 2, 4, 5-T, and agent white, containing 2, 4-D and picloram, were applied at rates of 11.7 pounds per acre and 5.6 lbs. per acre respectively in multiple applications (Golley, 1971; Tschirley, 1969). In much of the sprayed areas, reestablishment of the original forest has been negligible. (Golley, 1971). One such area, the Rung Sat Delta, south of Saigon, was chosen to study the possible causes of the lack of colonization. The area is thought to have been last sprayed in 1970. Mangroves which once covered about 80% of the area have been killed and the remaining dead wood harvested for fuel. Aerial photographs taken in 1971 indicate little or no seedling growth in this area.

Originally the area consisted of a gradient from predominantly red mangroves (Rhizophora sp.) on the seaward side to a mixture of red and black mangrove (Avicennia sp.) on the inland side. The seaward side is inundated daily with salinities ranging from 25 to 35 parts per thousand, while on the inland side inundation occurs only during the highest tides and salinities are less, ranging between 15 and 25 ppt. The Saigon River borders the area to the west. Mangroves still occur to the north, interspersed with farmland.

Climatic data for the region are scarce, but some data are available from Tan-Son-Nhut (Saigon). Rainfall is greatest in September and lowest in February (Table 1). Temperatures are warmest in May, but the mean monthly air temperatures vary less than four degrees annually.

Table 1. Maximum, minimum, and mean monthly air temperatures (°C) and mean precipitation (mm) for Saigon, Viet Nam (after Conway (1963) and Cuong (1964)).

Month	Maximum air temperature	Minimum air temperature	Mean air temperature	Precipitation
January	32	17	24	6
February	33	18	25	3
March	36	19	27	6
April	38	20	28	55
May	38	18	28	200
June	35	18	26	205
July	33	18	25	200
August	32	18	25	184
September	33	17	26	198
October	31	17	26	202
November	31	16	24	64
December	31	15	24	35

Solar radiation remains at about 325-375 langley's day⁻¹ most of the year because of the constant cloudiness. The sunniest months, February, March, and April are also the driest (Table 2), with the daily radiation total increasing to 400-450 langley's day⁻¹.

The reasons why the mangrove vegetation is recovering slowly or possibly not at all are not yet known. It is however possible to speculate as to what is currently happening. The purpose of this paper is to bring together existing knowledge of the area in terms of climatological, geological, and physiological characteristics in order to attempt to understand the processes and interactions influencing redevelopment in the Rung Sat area. The method we shall use is digital modeling. Without giving an extensive review of the history and validity of digital modeling, digital modeling as a technique in understanding relationships and interactions within a system, whether it be biological, chemical, or physical, has demonstrated itself in the past to be a useful tool.

A model is only beneficial if it helps to clarify our understanding of relationships within a system. A model is most useful if it utilizes relationships and parameters which can be measured. Also the model should yield insight into the processes of the system that 1) require further investigation and 2) are most crucial to the system. This is the philosophy used in this modeling exercise. The model is based on data recorded in the literature and from field research on mangroves carried out in south Florida on an A.E.C. contract.

Although the reasons why mangrove vegetation is not recovering or is recovering very slowly are not clear, several hypotheses that could be

Table 2. Mean monthly values of total solar radiation for Saigon from the Dept. of Commerce (1968). Units are langley's day⁻¹.

Month	Mean Langley's
January	350
February	422
March	456
April	438
May	368
June	391
July	386
August	369
September	356
October	335
November	316
December	316

tested using digital simulations were constructed. These hypotheses are attempts to delineate the physical and biological processes acting to constrain the redevelopment of the mangrove forests. The hypotheses stem from the idea that upon removal of the vegetation, the microclimate is changed. The new microclimate will then influence all of the vegetation attempting to establish in that area. Four principal hypotheses were constructed to be tested by the digital simulations. These were:

- 1) Surface temperatures lethal to propagules and seedlings may be produced at certain times of the year.
- 2) High leaf temperatures may be reached in the exposed seedling canopies causing a decrease in net production, and if leaf temperatures are high enough, an increase in seedling mortality.
- 3) The substrate surface dries faster than the mangrove seedlings can grow roots, and the propagules die of desiccation at certain times of the year.
- 4) Low immigration and high mortalities result in slow propagule establishment and reforestation.

Predation by man and herbivorous animals were not considered, nor was competition between mangroves and other species, such as grasses, because the principal constraint on the mangrove redevelopment was thought to be due to environmental factors or to physiological responses.

Two modeling approaches were undertaken: a total ecosystem model which simulates the redevelopment of mangroves over a span of several years, and a detailed physical and physiological response model (CANOPY) of mangrove-environment interactions, which simulates a period of twenty-four hours.

Description of each model and a discussion of the data base, simulation results, and conclusions are presented separately in the following section.

DESCRIPTION OF THE DETAILED PHYSICAL AND PHYSIOLOGICAL
RESPONSE MODEL

I. CANOPY

CANOPY is a canopy-microclimate-primary production model which estimates hourly values of net primary production and transpiration by strata throughout a canopy. CANOPY calculates the microclimate of the strata and then evaluates the effect of the microclimate on the vegetation. The model will be discussed in two parts: 1) a description of the processes influencing the micrometeorological profiles and 2) a description of the processes influencing leaf temperature and primary production.

To best understand how CANOPY works, we will briefly run through one cycle of the program (Figure 1). This description is given here in order to give the reader an idea of the processes and interactions involved in the model. Input data necessary for CANOPY include hourly microclimate values, canopy leaf area distributions, and physiological parameters for the species being modeled (Tables 3-5). Hourly calculations are then made on the processes within the canopy which influence primary production, transpiration, and energy exchange. Short wave radiation penetration through the canopy is calculated as described by Miller (1969, 1972b). Transpiration, internal leaf water status, and water uptake rates are then calculated. The profiles of microclimatic variables are determined by a modification of the model discussed by Waggoner and Reifsnnyder (1968). Leaf temperatures are calculated by an iterative solution of the leaf energy budget. Finally, net photosynthesis is estimated. Hourly summaries are printed, after which the model proceeds to the next hour with the information needed from the previous hour. A flowchart of CANOPY appears as Figure 1a.

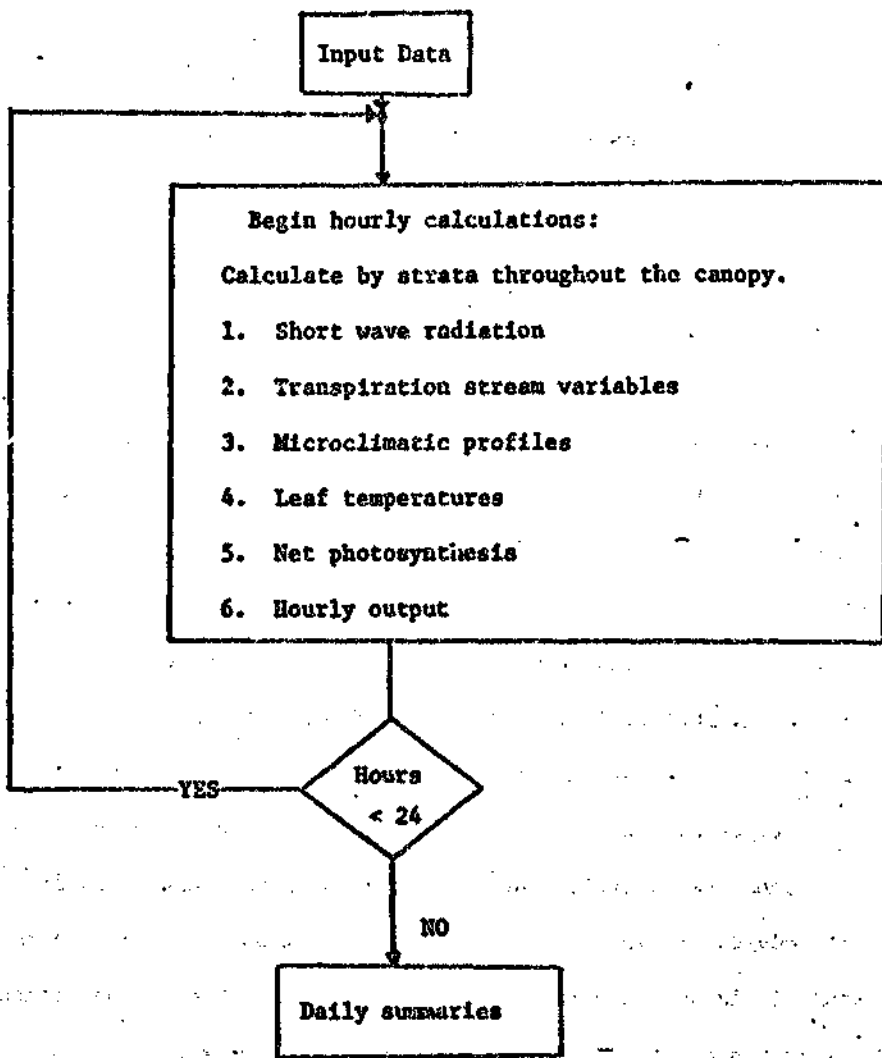

Figure 1. General flowchart of the program CANOPY.

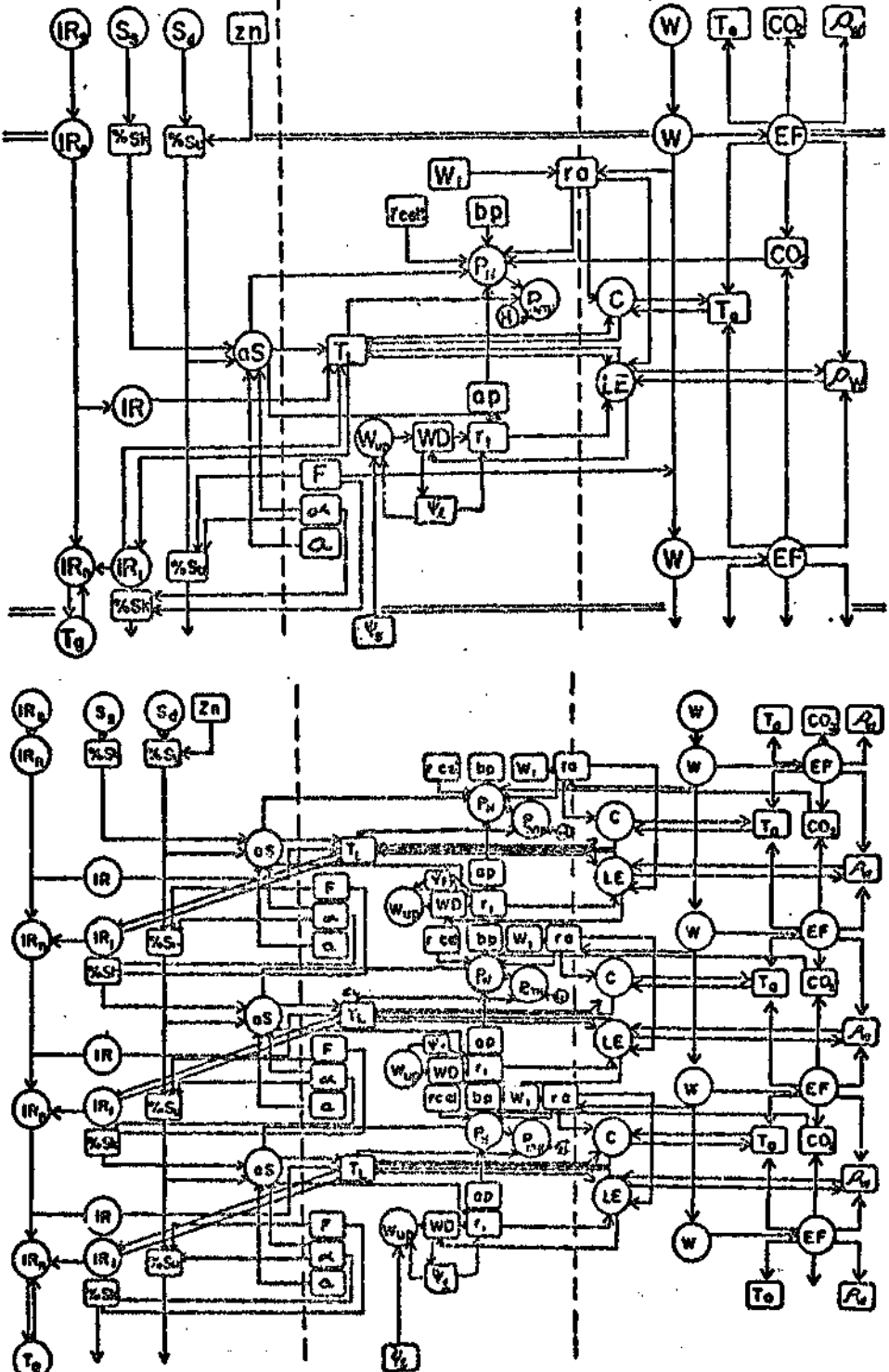

Fig. 1. Flow charts illustrating the interrelations between canopy variables and physical processes. Symbols are defined and explained in the text. The upper chart illustrates the interrelations for one level in the canopy; the lower chart, for a canopy divided into three levels. (after Miller, 1972)

Table 3 . Microclimate input data for CANOPY. All values are for a point just above the top of the canopy. Units for radiation are $\text{cal cm}^{-2} \text{min}^{-1}$, for air temperature degrees Celsius, for vapor density g m^{-3} , and wind velocity cm sec^{-1} .

February sunny

Hour	Total solar	Diffuse solar	Infrared from sky	Air temperature	Air vapor den.	Wind velocity
1	0	0	0.60	23.0	19.0	60.
2	0	0	0.60	22.0	19.0	60.
3	0	0	0.60	21.0	19.0	60.
4	0	0	0.60	20.0	19.0	60.
5	0	0	0.60	19.0	18.5	60.
6	0	0	0.60	20.0	19.0	80.
7	0.10	0.10	0.60	21.0	19.5	100.
8	0.50	0.10	0.60	24.0	20.0	125.
9	1.00	0.20	0.60	27.0	20.0	150.
10	1.15	0.25	0.60	29.0	20.0	175.
11	1.20	0.30	0.60	31.0	20.0	200.
12	1.30	0.30	0.60	32.0	20.5	225.
13	1.20	0.30	0.60	31.5	21.0	250.
14	1.15	0.30	0.60	30.5	20.5	200.
15	1.00	0.25	0.60	30.0	20.0	175.
16	0.80	0.25	0.60	30.0	20.0	150.
17	0.50	0.20	0.60	29.5	20.0	150.
18	0.10	0.10	0.60	29.0	19.5	80.
19	0	0	0.60	28.5	19.5	80.
20	0	0	0.60	28.0	19.5	60.
21	0	0	0.60	27.0	19.0	60.
22	0	0	0.60	26.0	19.0	60.
23	0	0	0.60	25.0	19.0	60.
24	0	0	0.60	24.0	19.0	60.

Table 3. (continued).

February average

Hour	Total solar	Diffuse solar	Infrared from sky	Air temperature	Air vapor density	Wind velocity
1	0	0	0.60	22.0	19.0	60.
2	0	0	0.60	22.0	19.0	60.
3	0	0	0.60	22.0	19.0	60.
4	0	0	0.60	22.0	19.0	60.
5	0	0	0.60	23.0	19.0	60.
6	0	0	0.60	24.0	19.0	80.
7	0.10	0.05	0.60	25.0	19.0	100
8	0.40	0.20	0.60	26.0	19.0	125.
9	0.70	0.30	0.60	27.0	19.0	150.
10	0.80	0.30	0.60	27.0	19.0	175.
11	0.90	0.40	0.60	27.0	19.0	200.
12	1.10	0.50	0.60	28.0	19.0	225.
13	0.90	0.60	0.60	28.0	19.0	250.
14	0.80	0.60	0.60	28.0	19.0	225.
15	0.70	0.50	0.60	27.0	19.0	200.
16	0.60	0.40	0.60	27.0	19.0	150.
17	0.40	0.30	0.60	27.0	19.0	150.
18	0.10	0.10	0.60	26.0	19.0	100.
19	0	0	0.60	26.0	19.0	80.
20	0	0	0.60	25.0	19.0	60.
21	0	0	0.60	24.0	19.0	60.
22	0	0	0.60	23.0	19.0	60.
23	0	0	0.60	22.0	19.0	60.
24	0	0	0.60	22.0	19.0	60.

Table 3. (continued).

May sunny

Hour	Total solar	Diffuse solar	Infrared from sky	Air temperature	Air vapor den.	Wind velocity
1	0	0	0.60	25.5	24.0	60.
2	0	0	0.60	25.0	24.0	60.
3	0	0	0.60	24.5	24.0	60.
4	0	0	0.60	24.0	24.0	60.
5	0	0	0.60	24.0	24.0	60.
6	0.05	0.05	0.60	25.0	24.0	60.
7	0.35	0.10	0.60	28.0	24.0	100.
8	0.70	0.20	0.60	31.0	24.0	125.
9	1.10	0.50	0.60	33.0	24.0	150.
10	1.15	0.60	0.60	35.0	24.5	175.
11	1.00	0.70	0.60	35.0	24.5	200.
12	0.90	0.70	0.60	35.0	24.5	225.
13	0.80	0.80	0.60	33.0	24.5	250.
14	0.70	0.70	0.60	32.0	25.0	225.
15	0.65	0.65	0.60	31.0	25.0	200.
16	0.60	0.60	0.60	30.0	24.5	150.
17	0.50	0.50	0.60	29.5	24.4	150.
18	0.40	0.40	0.60	29.0	24.5	100.
19	0.10	0.10	0.60	28.5	24.5	80.
20	0	0	0.60	28.0	24.0	60.
21	0	0	0.60	27.5	24.0	60.
22	0	0	0.60	27.0	24.0	60.
23	0	0	0.60	26.5	24.0	60.
24	0	0	0.60	26.0	24.0	60.

Table 3. (continued).

May average

Hour	Total solar	Diffuse solar	Infrared from sky	Air temperature	Air vapor den.	Wind velocity
1	0	0	0.60	26.0	24.0	60.
2	0	0	0.60	26.0	24.0	60.
3	0	0	0.60	26.0	24.0	60.
4	0	0	0.60	26.0	24.0	60.
5	0	0	0.60	26.0	24.0	60.
6	0	0	0.60	26.0	24.0	80.
7	0.20	0.10	0.60	26.0	24.0	100.
8	0.50	0.30	0.60	28.0	24.0	125.
9	0.70	0.40	0.60	29.0	24.0	150.
10	0.80	0.40	0.60	30.0	24.0	175.
11	0.70	0.60	0.60	30.0	24.0	200.
12	0.70	0.70	0.60	30.0	24.0	225.
13	0.60	0.60	0.60	30.0	24.0	250.
14	0.60	0.60	0.60	30.0	24.0	225.
15	0.50	0.50	0.60	30.0	24.0	200.
16	0.40	0.40	0.60	30.0	24.0	175.
17	0.25	0.25	0.60	30.0	24.0	150.
18	0.15	0.15	0.60	29.0	24.0	100.
19	0.00	0.10	0.60	28.0	24.0	80.
20	0	0	0.60	27.0	24.0	60.
21	0	0	0.60	27.0	24.0	60.
22	0	0	0.60	27.0	24.0	60.
23	0	0	0.60	27.0	24.0	60.
24	0	0	0.60	26.0	24.0	60.

Table 4. Stand structure used in the CANOPY simulations. The total LAI is approximately 0.45. Strata 1 is at the top of the canopy. The actual data is hypothetical, but canopies of similar structure are found in mangrove swamps.

Strata	Leaf Area Index	Leaf angle (°)
1	.002	60.
2	.050	54.
3	.075	48.
4	.100	42.
5	.100	36.
6	.075	30.
7	.050	24.
8	.003	18.

Table 5. Physiological input parameters to CANOPY and values used in the simulations. All data are for Rhizophora mangle.

Variable	Symbol	Value	Data Source
minimum leaf resistance	r_{\min}	0.04 min cm ⁻¹	Miller and Ehleringer(1972)
cuticular leaf resistance	r_{cut}	0.50 min cm ⁻¹	Miller and Ehleringer(1972)
photosynthesis light parameter	a_p	2.5 cm ² ly(gCO ₂) ⁻¹	Miller (1972)
photosynthesis light parameter	b_p	0.03 gCO ₂ lycm ²	Miller (1972)
absorptance	a	0.60	Miller (1972)
mesophyll resistance	r_{mes}	0.30 min cm ⁻¹	Moore, et al. (1972)
root resistance	r_r	0.2 min cm ⁻¹ bar ⁻¹	Miller and Ehleringer(1972)
stomatal light parameter	D	14. ly ⁻¹ min	Miller and Ehleringer(1972)
leaf resistance parameter	X	16.	Miller and Ehleringer (1972)
saturation leaf density	D_T	50 mg cm ⁻²	Miller (1972)

Photosynthesis System 1

leaf temperature w/ 0.0 net photosynthesis	T_o	10 °C	Moore, et al. (1972)
leaf temperature w/ 0.0 net photosynthesis	T_o	37 °C	Moore, et al. (1972)
optimum leaf temperature for photosynthesis	T_{opt}	27 °C	Moore, et al. (1972)

Photosynthesis System 2

T_o	10 °C	Hypothesized
T_o	40 °C	Hypothesized
T_{opt}	30 °C	Hypothesized

CANOPY incorporates several digital models which have been or are being described in the literature. These are: 1) a model to describe solar radiation penetration into the canopy from Miller (1969, 1972b); 2) a model to estimate net primary production, leaf temperatures, and physical processes within a canopy from Miller (1972a) and Miller and Tieszen (1972), 3) a model to describe water relations within plants from Miller and Ehleringer (1972), 4) a model to calculate microclimatic profiles from Waggoner and Reifsnnyder (1968), and 5) a model to calculate soil temperatures, soil water content, and the movement of heat and water in saturated and nonsaturated soils from Ng and Miller (1972). No attempt will be made here to give a complete description of the models as more complete discussions can be found in each respective paper.

CANOPY is an updating of these models, incorporating equations which express a more detailed mechanistic understanding of processes affecting primary production than were discussed in the Miller (1972a) primary production model. These additional equations will be discussed later. CANOPY is further modified to simulate processes affecting primary production and revegetation of mangroves in the Rung Sat Delta, Viet Nam.

Specific features of CANOPY for the Rung Sat simulations include the hypothesized effects of herbicides on photosynthesis and the effect of salt water on the soil water potential and on transpiration.

II. MICROMETEOROLOGICAL PROFILES

Micrometeorological profiles are calculated by four submodels: WAR, RADMOD, SOILT, and INFRA. WAR is the submodel to calculate air temperature and vapor density profiles, modified from Waggoner and Reifsnnyder (1968). RADMOD is the Miller (1972b) submodel for calculating short wave radiation

profiles within the canopy. The submodel for the calculation of values for soil variables is SOILT and is adapted from Ng and Miller (1972). INFRA is a submodel which calculates infrared radiation profiles.

As microclimatic input data to CANOPY, we need 24 hour values of total short wave radiation, diffuse short wave radiation, infrared radiation from the sky, air temperature, and the vapor density for a point just above the canopy. Given also the leaf area, leaf angle distribution, and the declination of the sun for the 24 hour period, the microclimatic profiles for air temperature, vapor density, and short and long wave radiation. Utilizing the canopy leaf area distributions, RADMOD calculates profiles of direct, diffuse, and reflected radiation.

The WAR submodel uses as input the solar radiation profiles, air temperature and vapor density above the canopy, the soil surface temperature, the vapor density just above the soil surface, and the profile of diffusive leaf resistances. The values for the profile of leaf resistances come from the transpiration stream calculations portion of CANOPY. Soil temperature and vapor density just above the soil surface are calculated by SOILT. SOILT calculates the surface temperature, soil water content (volume/volume), soil suction, and soil water potentials (bars) to a depth where daily fluctuations no longer occur.

The WAR submodel then proceeds to iteratively solve for the air temperature and vapor density profiles while leaf temperatures are being calculated. An intermediate infrared radiation submodel INFRA supplies calculated values of infrared radiation from leaves, ground, and sky to the leaf and air temperature calculations.

III. LEAF TEMPERATURES

Leaf temperature calculations are based on the heat transfer equation for a single leaf (Gates, 1962; Miller, 1967) which states that in an equilibrium state the energy absorbed by a leaf equals the energy lost. Moreover the absorbed energy from solar and infrared radiation and convection is lost by reradiation, convection, and transpiration. Thus

$$aS + \epsilon IR = IR_2 + C + LE \quad (1)$$

where: a is the leaf absorptance to solar radiation; S is the solar radiation incident on the leaf; ϵ is the absorption of the leaf to infrared radiation; IR is the infrared radiation from the environment incident on the leaf; IR_2 is the infrared reradiation by the leaf; C is the convective energy exchange; L is the latent heat of evaporation; and, E is the evaporation rate.

Each process by which energy is lost from the leaf depends on the leaf temperature. Thus if the leaf temperature is T_2 in $^{\circ}C$,

$$IR_2 = \sigma \epsilon (T_2 + 273.)^4 \quad (2)$$

$$C = h_c (T_2 - T_a) \quad (3)$$

$$E = (\rho_{s, T_2} - \rho_a) (r_l + r_a)^{-1} \quad (4)$$

where: σ is the Stefan Boltzmann constant; h_c is the convection coefficient; ρ_{s, T_2} is the saturation vapor density at leaf temperature; ρ_a is the vapor density of the air; r_l is the leaf resistance to water loss; and, r_a is the laminar boundary layer resistance. Once the absorbed radiation is known, leaf temperature and transpiration can be calculated by solving the above equations simultaneously by iteration.

IV. PRIMARY PRODUCTION CALCULATIONS

The net photosynthetic rate is a good index of the rate of primary production. This being the case, we focus our model of primary production on determining the rates of net photosynthesis at the different strata within a canopy. The physiological leaf parameters determining the rate of photosynthesis become quite important. If a model is to accurately simulate photosynthesis, it must also accurately simulate those parameters which indirectly determine the rate of photosynthesis.

Net photosynthesis is related to the absorbed solar radiation, atmospheric carbon dioxide content, leaf resistance, boundary layer resistance, and mesophyll resistance by the equations:

$$P_N = \frac{[CO_2]_a - [CO_2]_{chl}}{r_a + 1.56r_l + r_{mes}} \quad (\text{modified after Ganatra, 1963}) \quad (5)$$

$$P_N = (aS) (a_p aS + b_p)^{-1} \quad (\text{Monteith, 1965}) \quad (6)$$

where: P_N is the unadjusted net photosynthetic rate; $[CO_2]_a$ and $[CO_2]_{chl}$ are the carbon dioxide concentrations in the air and at the chloroplasts; r_{mes} is the mesophyll resistance to carbon dioxide transport; and, a_p and b_p are parameters empirically derived from the photosynthesis light response curve. The leaf resistance to water transfer is modified for carbon dioxide diffusion by multiplying by the ratio of the diffusion coefficients of carbon dioxide and water.

Leaf temperature and herbicide influence net photosynthesis through the equations:

$$P_{NT} = (P_N)(T_l - T_o)/(T_{opt} - T_o) \quad (7)$$

$$P_{NTH} = (P_{NT}) (1 - H) \quad (8)$$

$$H = bhe^{-kt} \quad (9)$$

where: P_{NT} is the net photosynthetic rate after the effect of temperature is included; T_0 is the leaf temperature at which net photosynthesis equals zero; T_{opt} is the optimum leaf temperature for photosynthesis. There are two values for T_0 , one on either side of T_{opt} . The one used depends on which side of the optimum leaf temperature the leaf temperature falls.

P_{NTH} is the net photosynthetic rate after the effects of the herbicide have been included; H is the relative effect of the herbicide on photosynthesis; b relates the herbicide concentration to its effect on the photosynthetic process; h is the initial herbicide concentration; k is the decay coefficient for the herbicide; and t is the elapsed time since the herbicide application.

Net photosynthesis is first calculated by equations (5) and (6), and the smaller of the two values is taken as the actual value. This allows photosynthesis to be limited by both light and by carbon dioxide diffusion. The calculated value of net photosynthesis is then corrected for the effects of leaf temperature and herbicides. Temperature and herbicide effects are assumed to be linear. Linear interpolation for the temperature effects on photosynthesis yields a fair approximation to the temperature response data of Moore et al. (1972).

Net photosynthesis for the canopy is calculated as

$$P_T = \sum_{i=0}^n (P_{NTH}) (LAI_i) \quad (10)$$

where: P_T is the total net photosynthesis; P_{NTH} is the net photosynthetic rate at the i -th level; LAI_i is the leaf area index at the i -th level; and, n is the number of levels in the canopy.

V. TRANSPIRATION STREAM CALCULATIONS

Water movement out of the leaves is related to the vapor density gradient and to the resistances to water diffusion by the equation as previously described in equation (4).

Internal leaf water status is dependent on the leaf water deficit. This is the relative saturation deficit (Barrs, 1968) from the fully turgid state. It is expressed as a percentage and is related to the transpiration and water uptake rates as

$$WD_t = WD_{t-1} + D_T^{-1} \int (E - W_{up}) dt \quad (11)$$

where: WD_t and WD_{t-1} are the leaf water deficits at time t and time $t-1$; D_T is the saturation leaf density, and W_{up} is the water uptake rate. The saturation leaf density is defined as the fully turgid leaf weight per square centimeter.

The leaf water potential is calculated as a second order regression from the data of Miller and Ehleringer (1972). The regression is

$$\psi_L = -0.78 - 0.46WD - 0.032WD^2 \quad (12)$$

where ψ_L is the leaf water potential.

The water uptake rate is calculated using the Ohm's Law analogy, where the potential driving force is the water potential gradient between the leaf and the soil. Resistance to water uptake is offered by the roots and the

soil. The uptake rate is also moderated by the relative surface areas of the roots and leaves. Thus,

$$W_{up} = \alpha(\psi_s - \psi_l) / (r_r + r_s) \quad (13)$$

where: α is the ratio of root to shoot surface areas; ψ_s is the soil water potential; and, r_r and r_s are the resistances to water transfer of the roots and soil respectively. These resistances are assumed to be constant.

Soil water potential is related to the seawater and is herein assumed to contain only sodium chloride, so the equation for soil water potential simplifies to,

$$\psi_s = \beta S_s + \gamma S_{sc} \quad (14)$$

where: β is a conversion factor relating mean soil suction (S_s) to water potential; γ is a conversion factor relating molarity of sodium chloride to water potential; and S_{sc} is the salinity of the seawater.

Leaf resistance to water loss is related to the solar radiation absorbed by the leaf and the internal water status by the equation,

$$r_l = \frac{r_{cut} - aS(gND + mND^x)}{1 + aS(D)} \quad \text{(from Miller and Ehleringer, 1972)} \quad (15)$$

where: r_{cut} is the cuticular resistance, the resistance with the stomata completely closed; g and m are constants related to the water deficit at which the minimum resistance occurs; x is an exponent related to the steepness of the leaf resistance-water deficit curve at high water deficits; and, D is a parameter related to the stomatal opening with light.

Transpiration stream calculations commence with the calculation of the

the leaf water deficit, based on the transpiration rate and water uptake rate of the previous period. Calculation of the leaf water potential follows, after which the leaf resistance can then be calculated. The soil water potential and uptake rates are calculated after the leaf resistance. Transpiration is solved for iteratively as the leaf temperature is being calculated. Total water loss by the canopy is calculated in a manner identical to the calculation of net photosynthesis in equation (10).

VI. CLIMATIC INPUT DATA

The CANOPY simulations used climate data for the months of February and May as input data. These two months were chosen as they represent extremes in climate conditions. February is the driest and one of the sunniest months of the year, whereas May is one of the warmest and cloudiest months (Tables 1, 2).

If the environment is too harsh for mangrove seedling survival, then through the simulation of the primary production processes on these extreme months insight into the potential reforestation problems may be gained. Our interest is in testing conditions which might be straining the system, not conditions under which the system will easily survive. Accordingly, four input days were used in CANOPY simulations. These were an average February day (450 ly), an extreme sunny February day (600 ly), the average May day (350 ly), and a sunny May day (500 ly) in which the maximum monthly temperature was reached.

The probabilities of having the sunny February day or having the sunny May day are not known, because we do not have daily temperature records for the

area. By comparison though with climates of other areas we put forth the possibility that the chances of having these extreme days could be between 0.25 and 0.10.

RESULTS AND DISCUSSION

Canopy Simulation

A series of simulations were run using the four climate days previously described. Additionally, two different photosynthesis temperature response curves (Table 2) and three different substrate salinities were simulated. Two different photosynthesis temperature response curves were used as the temperature adaptations of the Viet Nam mangroves were not known. The temperature response curve for the lower optimum temperature has been measured on Rhizophora mangle in south Florida (Moore et al., 1972; Moore, unpublished data). The temperature response curve with the higher optimum temperature was used as it may be a more reasonable adaptation by mangroves to the warmer and more stable climate of Viet Nam. These results provide a complete matrix for comparative purposes to different locations along the salinity gradient of the Rung Sat Delta area.

The soil characteristics and properties used in the simulations were that of a clay soil. Zinke (1972) after visiting the Rung Sat area describes the soil as being a silty, clay soil. There is a small difference in the two soils, but because the physical properties relating to the clay soil were the only ones available at the time of the simulations, they were the ones used. In the current simulations, it was also assumed that the soil surface was saturated, but not inundated. In essence, this is saying that the soil water potential is equal to the solute water potential of the incoming tide.

The leaf area index for these simulations was 0.45 which roughly corres-

ponds to a seedling density of 40 individuals per square meter. This assumes that each seedling has four leaves, and that each leaf is approximately 30 cm² in area (Table 4). This leaf area is used only for purposes of convenience in the simulations. In actuality, the appropriate leaf area would be less than 0.45. The main idea to remember is that in small sparse canopies, such as propagule canopies, the principle interactions are between the climate and the leaf, not between leaves. The use of a canopy with a leaf area index of 0.45 is small enough that interactions between leaves are still small.

The effect of herbicides in these simulations is assumed to be zero. This was done partly for simplification of the model, but mostly because residual concentrations, if any, and decomposition rates were not known.

The first simulation results are estimates of productivity, transpiration, and the internal physiological response to the four microclimate days. Comparing the February sunny day with the average February day (Figures 2-5), it appears that net photosynthesis on average days is three times higher than on sunny days (0.232 g O.M.m⁻²day⁻¹ vs. 0.706 g O.M. m⁻²day⁻¹ at a salinity of 12‰). From Figure 5 it can be seen that the reason for this drop in production is that the leaf temperatures on the sunny day are much higher. Transpiration is much higher on the sunny day as expected, but transpiration does not drop off as steeply when the salinity is increased on the sunny day as it does on the shady day. This suggests that on sunny days the role of solar radiation intensity is more important than that of substrate salinity. Mangroves on the sunny February day are under more water stress (Figure 4) and this in part is reflected in the higher leaf temperatures. Net photosynthesis appears to be almost constant with increasing salinity on both

Legend to Figures 2,3,4,5

- average February day
- sunny February day
- △** average May day
- ▲** sunny May day
- L** literature photosynthesis temperature response curve
- H** hypothetical photosynthesis temperature response curve

Figure 2. Daily transpiration totals for the microclimate days as a function of salinity

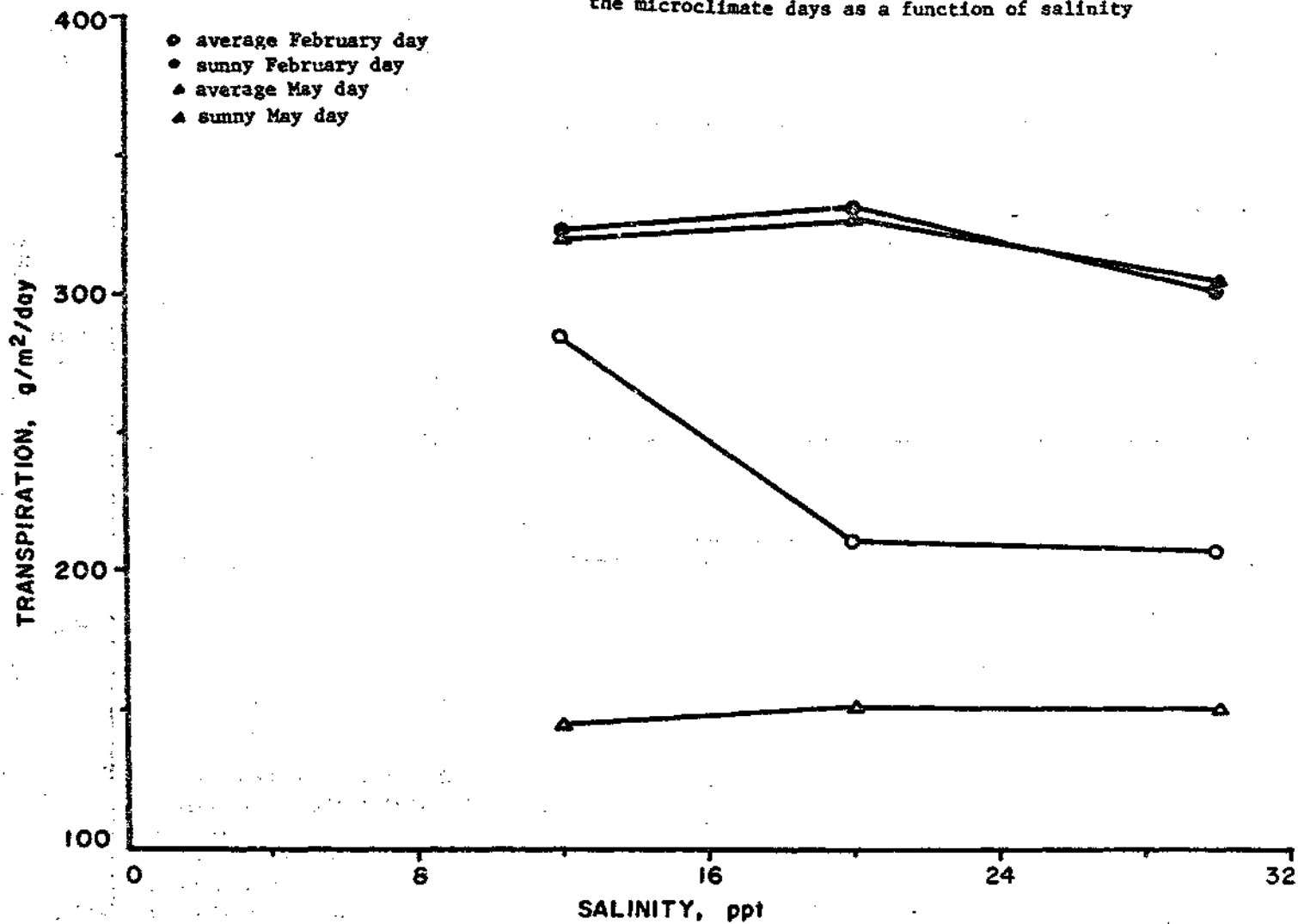

Figure 3 Daily production for the microclimate days as a function of salinity

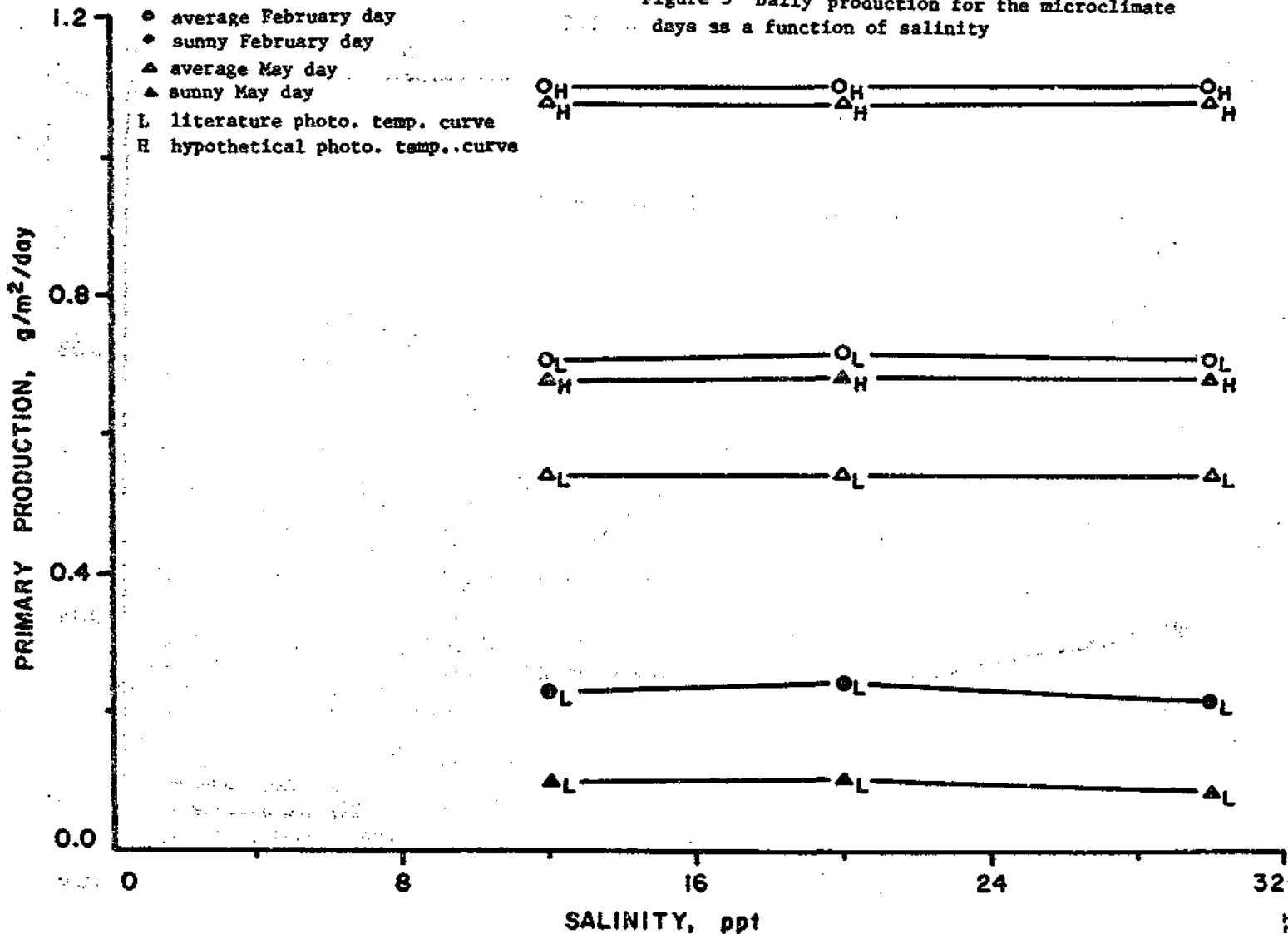

Figure 4 Minimum leaf water potential for the microclimate days as a function of salinity

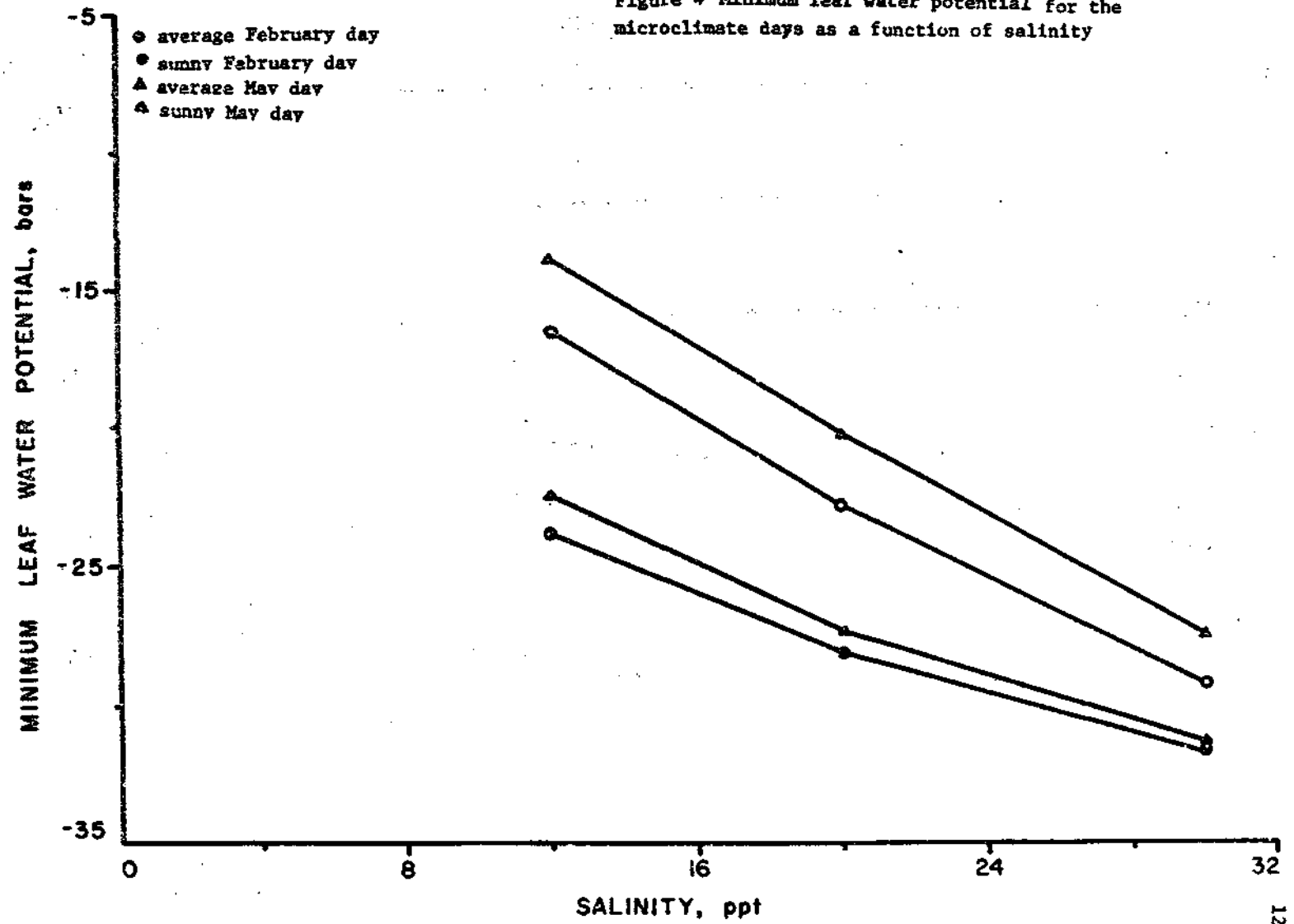
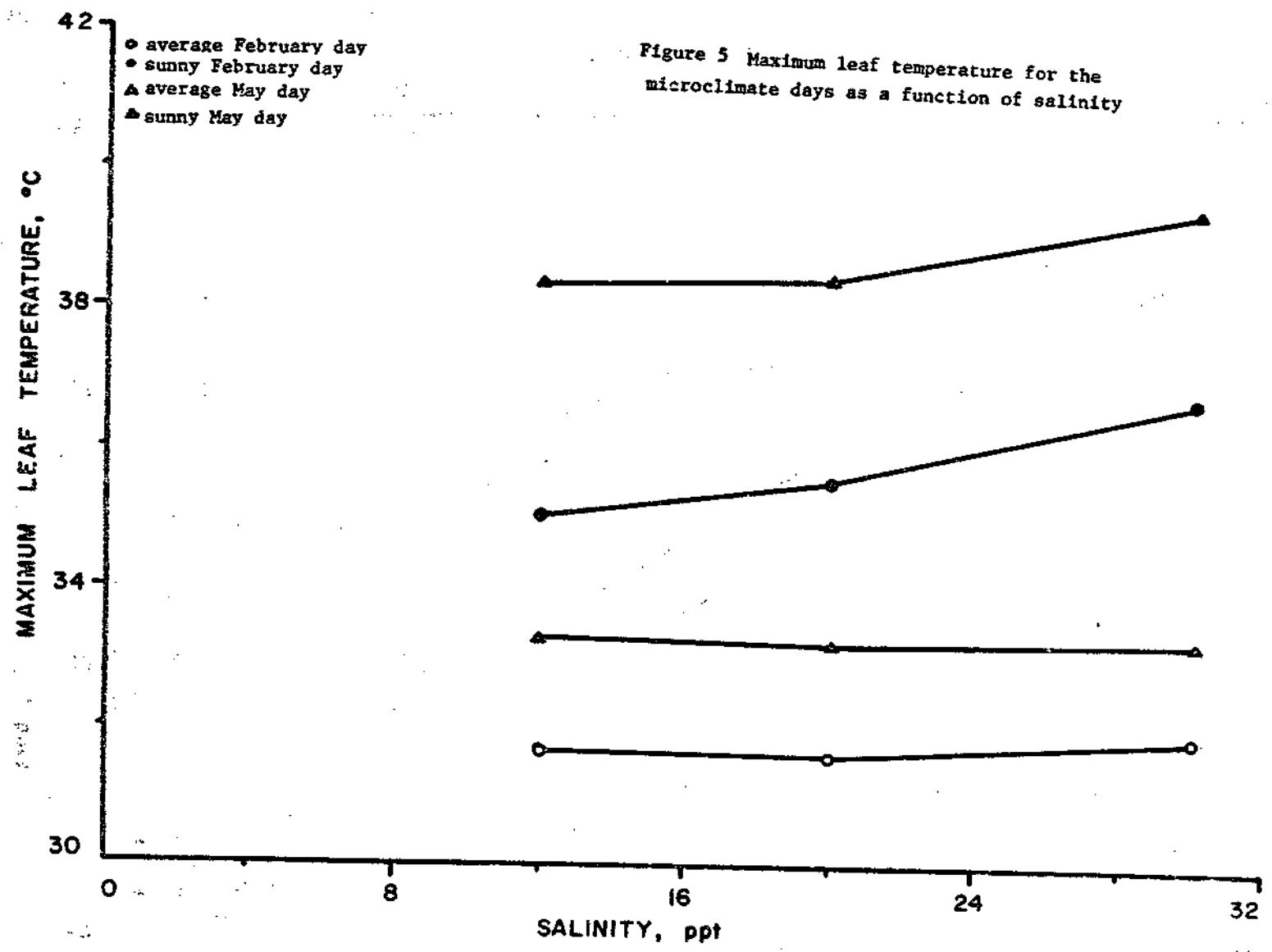

Figure 5 Maximum leaf temperature for the microclimate days as a function of salinity



February days. There is, however, a slight peak in production at a salinity of twenty parts per thousand.

A comparison of the sunny May day and the average May day shows similar trends. The discrepancy in production has increased so that on the average day the net production is five times greater than on the sunny day ($0.098 \text{ g O.M. m}^{-2} \text{ day}^{-1}$ vs. $0.542 \text{ g O.M. m}^{-2} \text{ day}^{-1}$ at a salinity of 12%). The difference is decreased when the hypothetical photosynthesis temperature response curve is used. By simply shifting the photosynthesis temperature response curve to the right three degrees C, we have lowered the difference down to a factor of two ($0.679 \text{ g O.M. m}^{-2} \text{ day}^{-1}$ vs. $1.065 \text{ g O.M. m}^{-2} \text{ day}^{-1}$ at 12 %). $0.5 \text{ g O.M. m}^{-2} \text{ day}^{-1}$ is gained by shifting the response curve because leaf temperatures are to the right of the optimum temperature and in a zone when production is sensitive to leaf temperature. Transpiration on the sunny May day compares well with transpiration of the sunny February day (Figure 2). However, transpiration on the average May day is much lower than any of the other days because the leaf temperatures were not abnormally high and the air vapor density was high, meaning that the vapor density gradient between leaf and air was low. Minimum leaf water potentials exhibit similar trends (Figure 4). The highest minimum leaf water potential and the lowest transpiration were on the average May day. This is because the vapor density gradient is lowest then.

Water stress can exist during either month. It can occur in February, because of the higher radiation loads and the drier air. It can occur in May because of the potential for high leaf temperatures.

The possibility of high leaf temperatures is interesting for several reasons. First, high leaf temperatures place a stress on the physiological

processes of photosynthesis and transpiration. Secondly, high leaf temperatures pose a threat when temperatures approach or exceed the lethal limit of the plant. Just exactly what the lethal limit is we do not know. One would suspect that the lethal temperature is close to the maximum temperature of positive net photosynthesis. Once this temperature is passed the respiration rate is very high and the breakdown of enzyme systems is occurring. Miller (1972c) has limited data showing that seedling mortality in Rhizophora mangle from south Florida starts when the temperature exceeds 36°C.

If high temperatures are not immediately lethal, then there still exists the possibility that some physiological functions in the developing propagule may have been impaired and that death may occur in later development. The immediate effects though of high leaf temperatures other than death are water stress through excessive transpiration and a decrease in the net photosynthetic rate. Following the daily course of leaf resistance, leaf water potential, leaf temperature, and the photosynthetic rate for each of the four days will permit us to observe how close to a stress condition the leaf is. Figures 6-9 show these physiological responses for the four climate days at a substrate salinity of thirty parts per thousand. The photosynthesis-temperature response curve used is the one measured by Moore, et al. (1972) for Rhizophora mangle. Across each graph a dashed line for a leaf temperature equal to thirty-six degrees is drawn. This corresponds to the potential lethal leaf temperature.

Potential lethal temperatures are reached for four hours on the May sunny climate and for one hour in the February sunny climate. No lethal temperatures

Legend to Figures 6,7,8,9

+	P	net photosynthesis	$\text{mg CO}_2 \text{ dm}^{-2} \text{ hr}^{-1}$
△	T	leaf temperature	°C
■	W	leaf water potential	bars
○	R	leaf resistance	min cm^{-1}

Figure 6 The daily course of physiological functions for the February average day

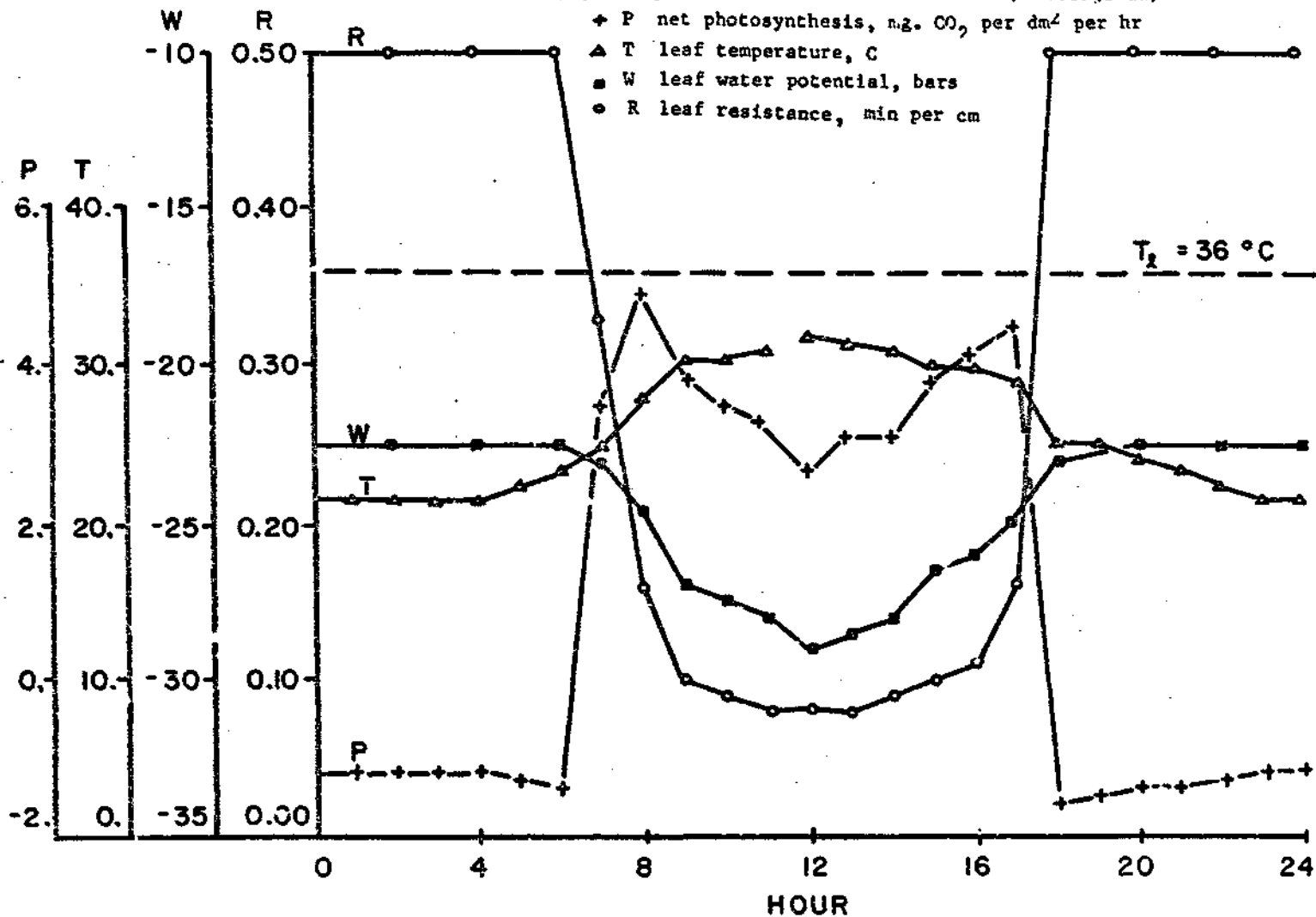

Figure 7 The daily course of physiological functions for the February

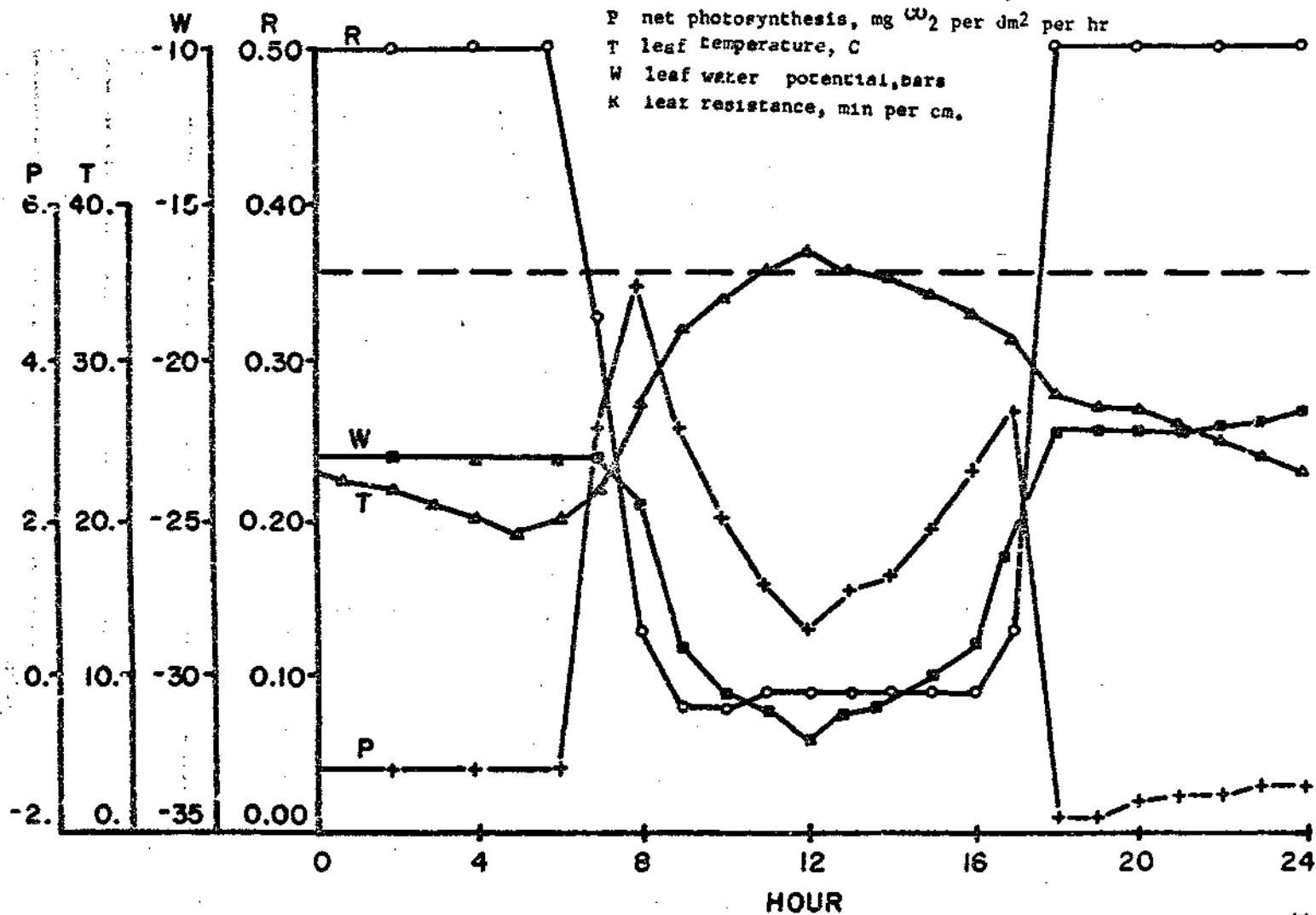

Figure 8 The daily course of physiological functions for the May average day

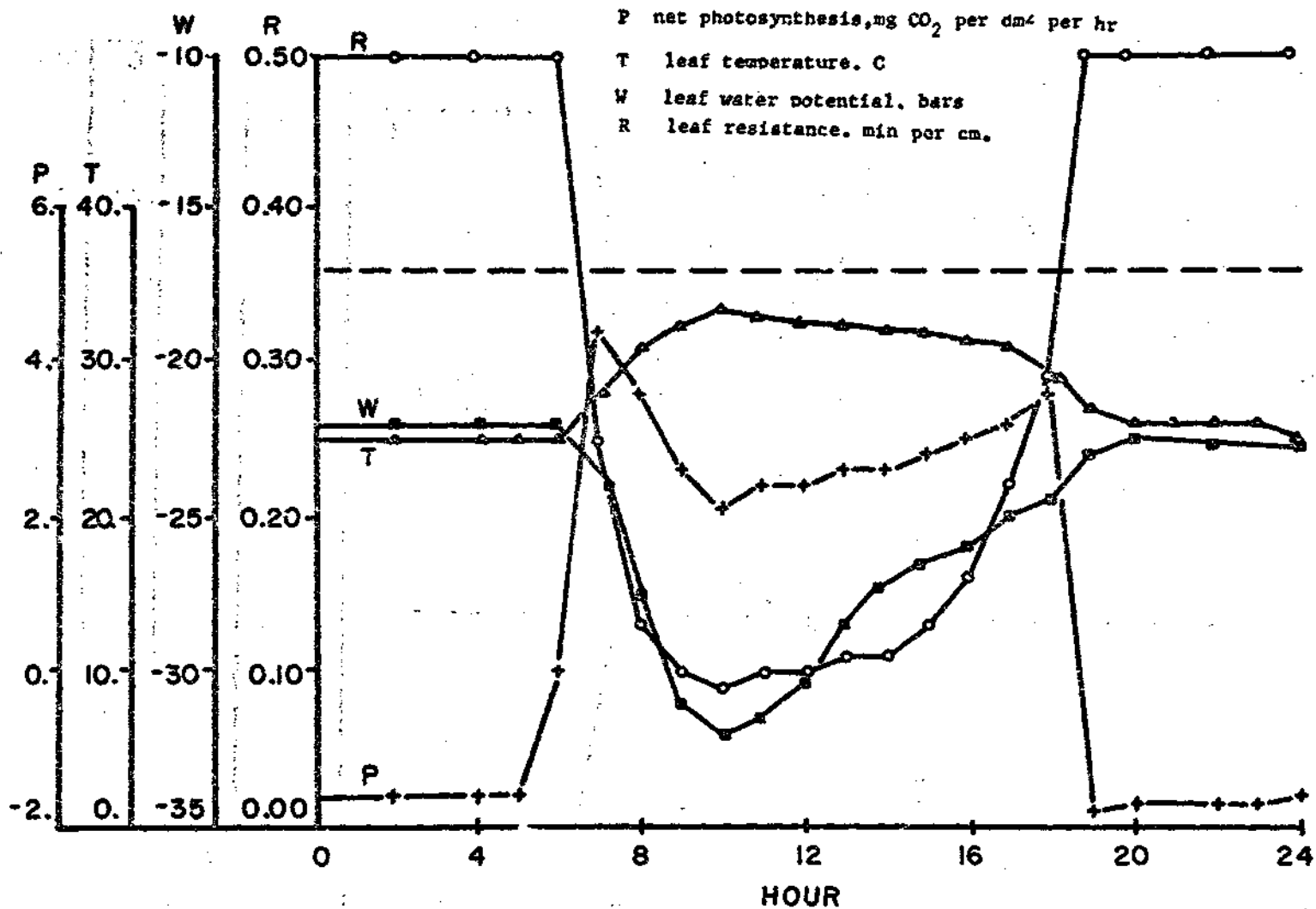
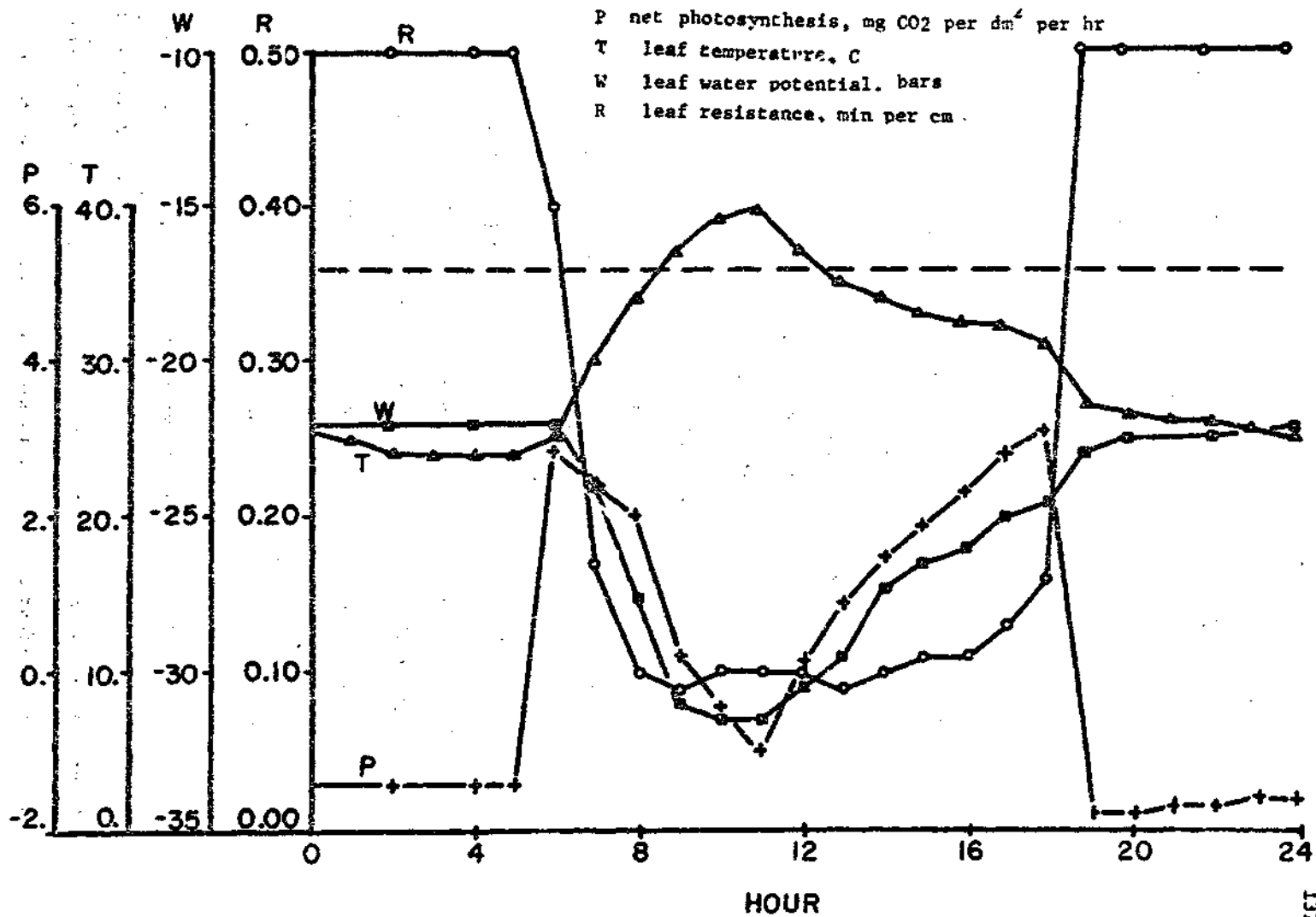

Figure 9 The daily course of physiological functions for the May sunny day



appear to be reached on the average climate days. Excessive water stress reflected in stomatal closure hardly occurs on the May sunny day.

The input parameters used may be underestimated here, and in reality, water stress may be more prevalent than the model would predict.

The model predicts about a 7-10 bar gradient between soil and leaf water potentials. As the soil continues to dry this gradient will increase, placing the propagule under additional water stress. The frequency of inundation will then play an important role in the mangrove propagule water relations. As the soil is a clay, infiltration will be slow and the soil will achieve a low water potential at volumetric contents as high as 20%.

Soil Moisture

These points suggest that perhaps the soil may be limiting the revegetation rate. It may be possible that the soil is drying out so fast that propagules are either unable to establish themselves or that the soil moisture evaporates before the propagules can utilize it, because of the radiation load on the soil surface. Simulations were performed to follow the water content change for the open soil surface for each of the four days. These simulations were done using three initial soil water contents (volume H_2O /volume soil). These were 30%, 20%, and 15%. These correspond to -4, -9, and -16 bars soil water potential respectively. The water content after a twenty-four hour period is noted and a percentage change is calculated (Table 6).

The results indicate that the water content drops off quickly from the saturated state. By the time the water content reaches 20%, the rate of water loss has become small. At a water content of 15%, water loss during a twenty-four hour period is negligible. This water content has a water potential of -16 bars. Additionally, we must add to this the

Table 6. Estimates of the rate at which the soil surface is drying out under open sky conditions and at different water contents for the three test days. Water content is in volume/volume.

Climate type	Initial water content at the beginning of the day	water content after 24 hours	percent change in one day
February sunny	0.300	0.276	8.0%
	0.200	0.199	0.5%
	0.150	0.150	0.0%
May average	0.300	0.274	8.7%
	0.200	0.198	0.7%
	0.150	0.150	0.0%
May sunny	0.300	0.274	8.7%
	0.200	0.198	0.7%
	0.150	0.150	0.0%
February average	0.300	0.277	7.9%
	0.200	0.199	0.3%
	0.150	0.150	0.0%

solute water potential of the salt from sea water. This total would put the plant under in high water stress condition. By adding the solute water potential, the plant may become under stress at water contents between 30% and 20%. The time to go from saturation down to a water content of 20% has not been calculated as it is also dependent on the drainage patterns.

Soil Temperature

The temperature at the soil surface is also of interest. It will be hotter in the day than if there was a canopy there, and colder at night. Just how much hotter during the day may be important. Simulations of the ground surface temperatures for bare soil and for an immature canopy of LAI 1.5 were made for the four climate days. The immature canopy is to serve as a contrast to the bare soil. The bare soil temperature is indicative of the temperature of a propagule lying flat on the surface of the soil. It is assumed that the propagule would be at or at least very close to the temperature of the bare soil. The bare soil in the simulations is assumed to be saturated, but with no standing water.

Figures 10-13 show that the surface temperatures can vary by only as much as three degrees between bare and covered soil. The chances of the soil approaching a lethal temperature appear to be quite small. The highest temperature reached is 38.2 °C (1100, May sunny), but temperatures are usually closer to 30°C. Bare soil surface temperatures appear not to be a deterrent to propagule invasion and establishment.

Redevelopment appears to be influenced by the rate of desiccation of the soil. Channelization and a modification of the soil through exposure may be amplifying this effect. Potential lethal temperatures and water

Figure 10 The daily course of ground surface temperatures on the February average day

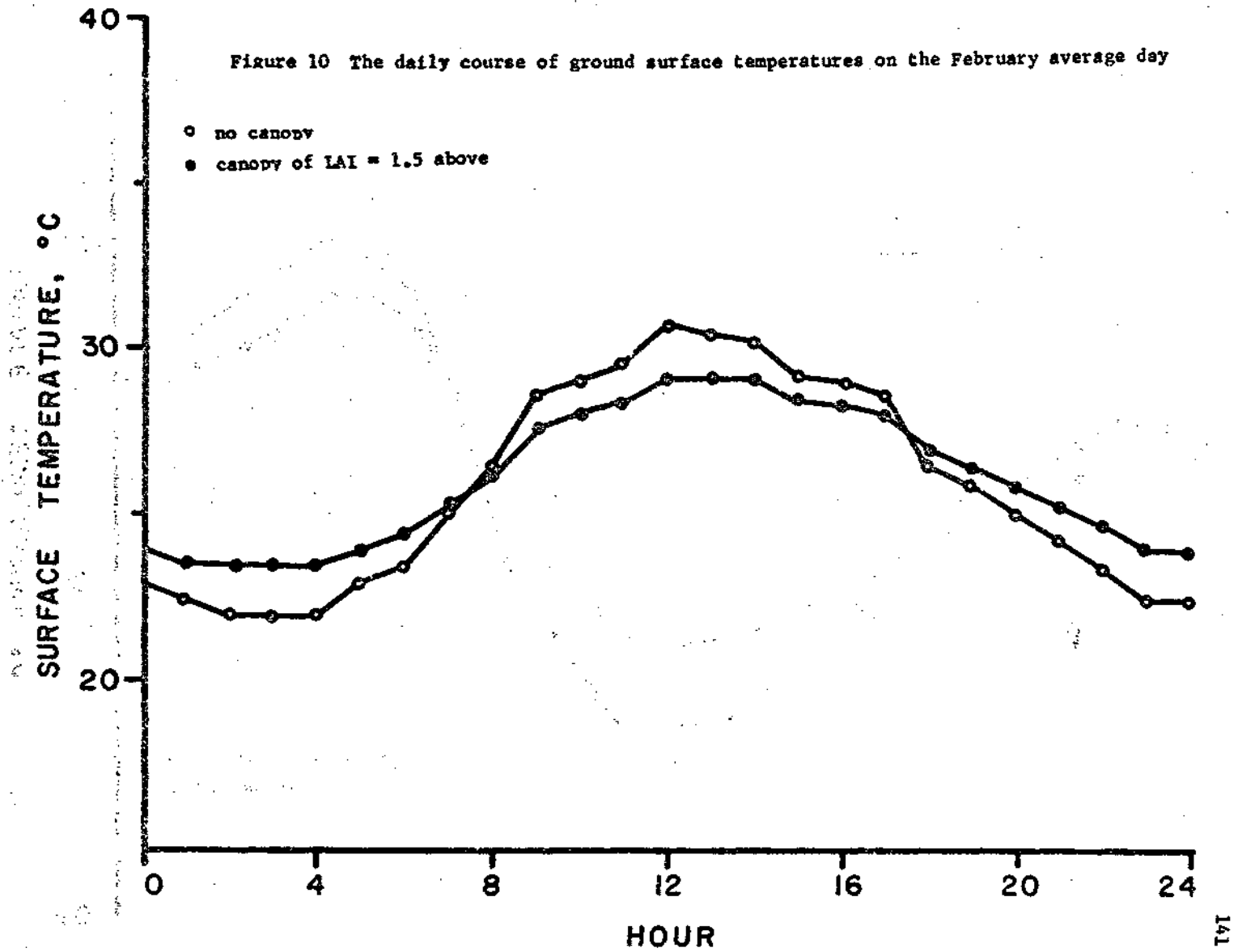

Figure 11 The daily course of ground surface temperatures on the February sunny day

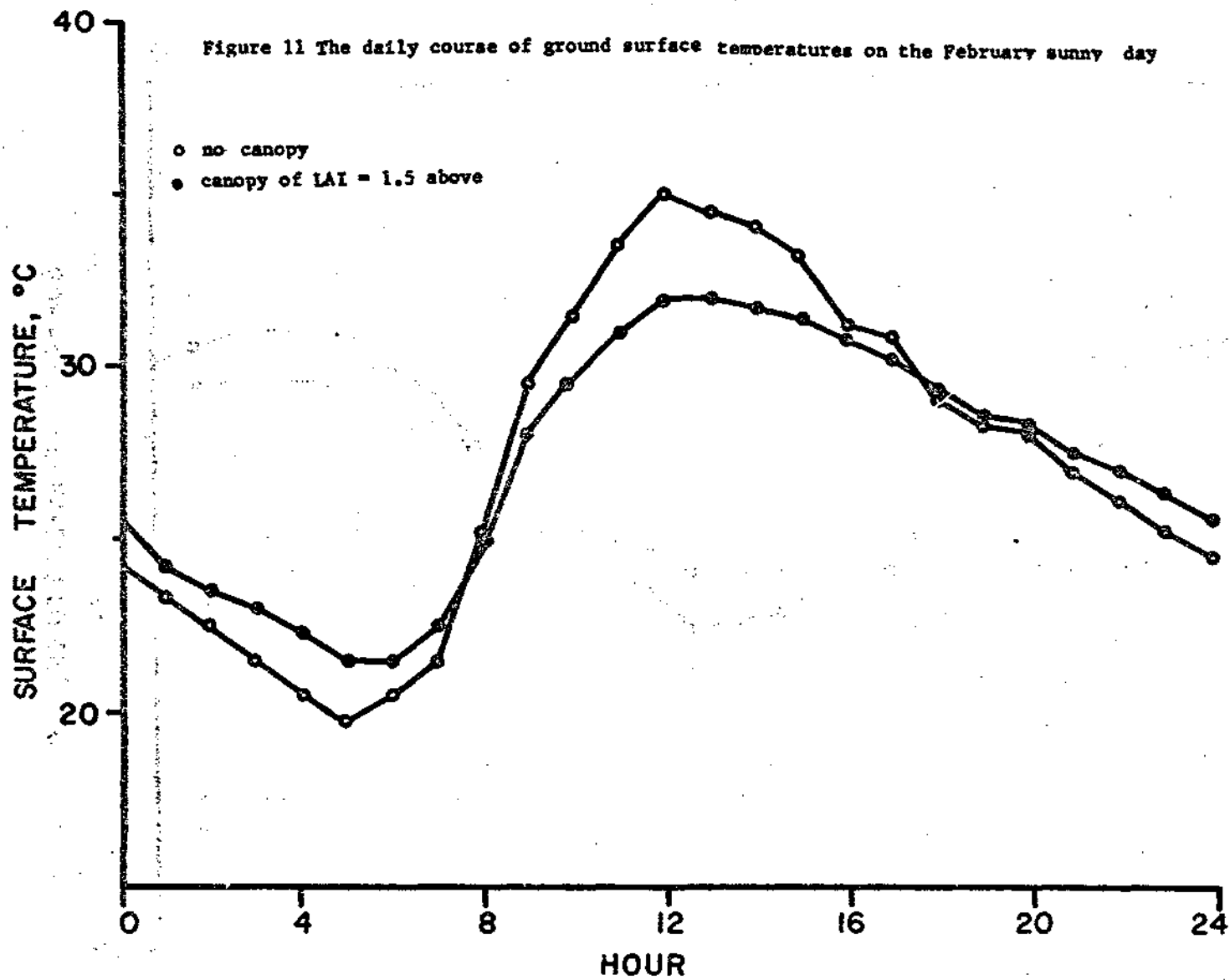

Figure 12 The daily course of ground surface temperatures on the May average day

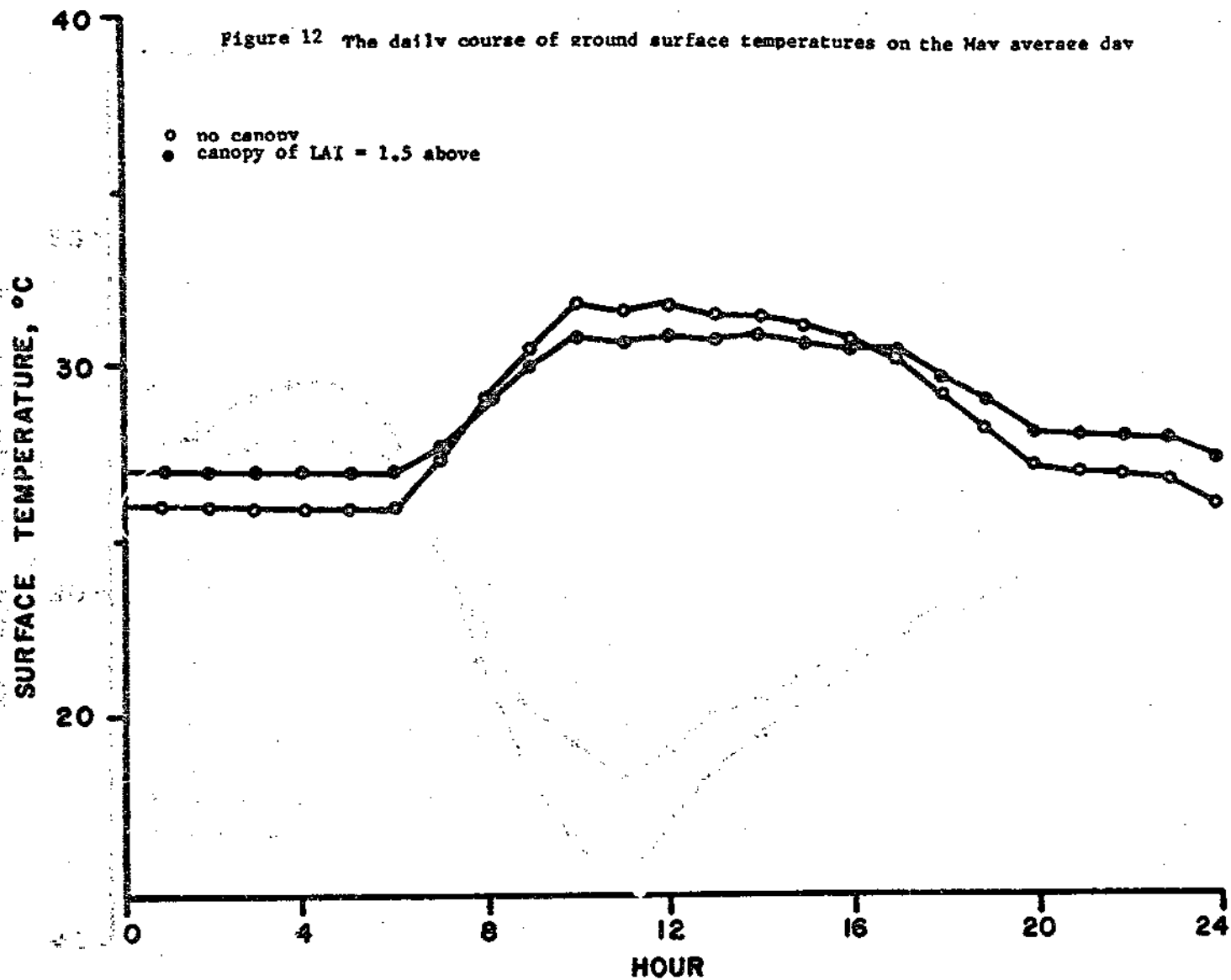
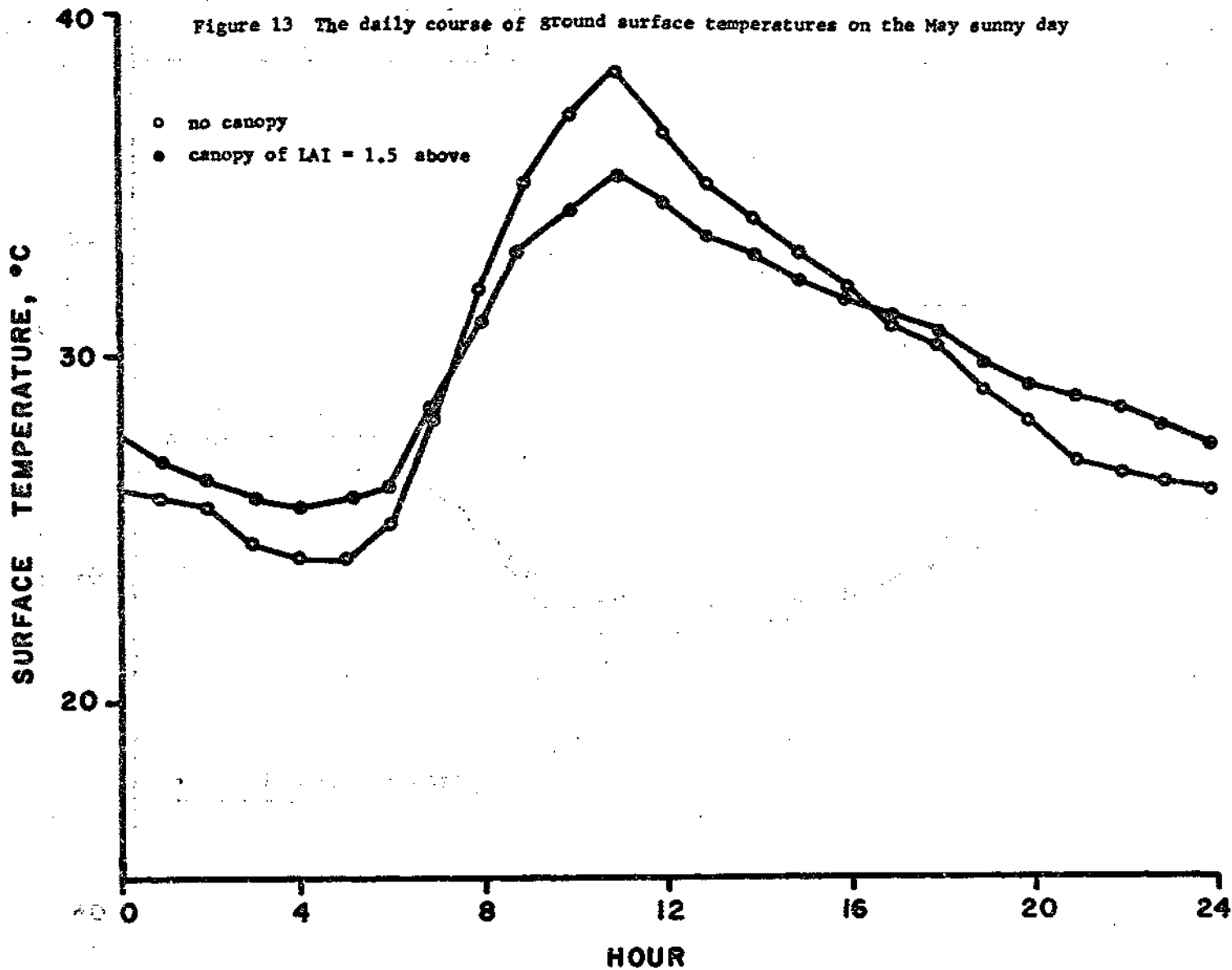

Figure 13 The daily course of ground surface temperatures on the May sunny day



stress conditions in leaves may exist for several hours on a number of days of the month in February and in May. It is also possible that these same stress conditions may be reached in other months of the year, although possibly to a lesser extent.

The lack of physiological data from Viet Nam detracts from the reliability of the model predictions. Actual estimates of parameters are expected to be different from those used in the simulations, but by the use of parameters from members of the same genus, it is thought that the values used will be close to the actual ones.

The critical variable influencing the system appears to be the microclimate. The success of reestablishment hinges on the stress placed on the propagule by the radiation load, the leaf-air vapor density gradient, and the rate of soil desiccation.

The long term simulation of red mangroves.

Currently in Viet Nam much of what used to be mangrove forests is now barren as a result of defoliation. Furthermore, reforestation appears to be impaired in some way. The following mathematical simulation is being used to determine possible long term causes. The two hypotheses being tested are: (1) the slow immigration of propagules retards reforestation and (2) the growth of propagules and seedlings is arrested as a result of increased temperature and salinity resulting from the initial defoliation. The red mangrove forest, Rhizophora mangle L., of the Rung Sat Delta was being modeled. Figure 14 is a simplified flow chart of the model. The description of the model will follow the order of the state variables in the figure as numbered with the description of the driving variable preceding.

Model Description

I. Macroclimate

The driving variables in the model are solar radiation, temperature, precipitation and salinity. Mean monthly data were used to approximate mean daily values by means of a linear interpolation between two adjacent monthly means. A standard year 's used throughout the simulation (see Table 7). Mean monthly temperature and total monthly precipitation were taken from Van Cuong (1964). Mean monthly total solar radiation was taken from summaries (Dept. of Commerce 1968) from the Saigon area. Mean monthly ambient salinities from a Florida brackish water mangrove swamp were used

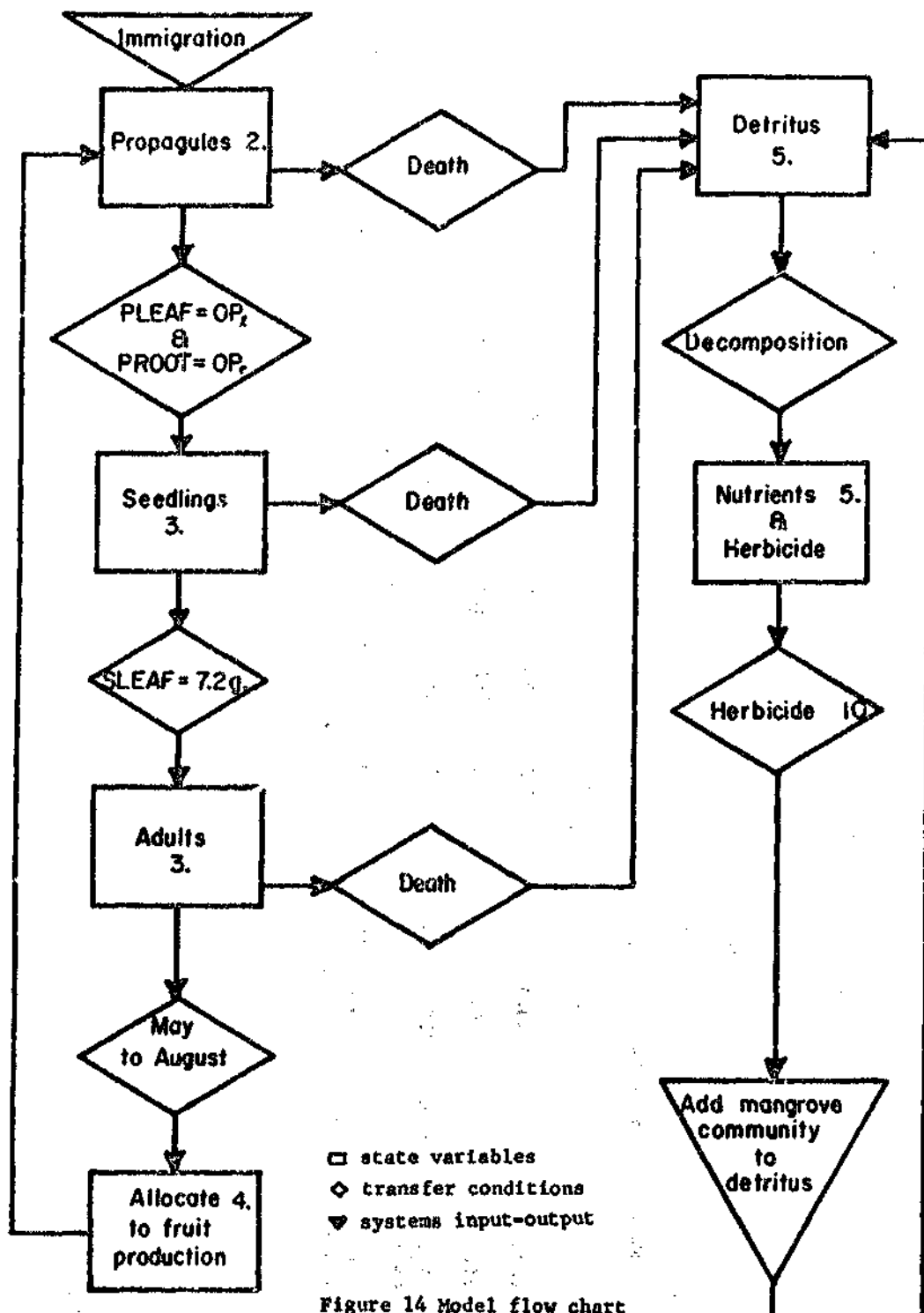

Figure 14 Model flow chart

Table 7 Macroclimate input

Month	1	2	3	4	5	6	7	8	9	10	11	12
Temperature (°C)	23.5	24.6	26.6	27.7	28.0	25.9	24.8	25.0	25.5	25.8	23.5	24.0
Precipitation (mm)	6.6	3.4	5.8	60.0	201.0	204.0	199.0	184.0	199.0	201.0	64.0	27.0
Total Solar Radiation (cal/cm ² /min)	350	422	456	438	557	391	386	369	355	334	316	316
Salinity (parts per thousand)	14.5	20.0	22.4	27.9	20.0	10.1	0.0	0.0	0.0	0.0	0.0	3.5

to approximate the daily values (Eric Heald, 1971). The salinity curve coincided with the solar radiation curve. Assuming a relationship between solar radiation and evaporation, the Florida salinities are used as an approximation to the Rung Sat Delta.

II. Propagules

The propagules are initiated through adult dropping and immigration from peripheral areas (Figure 15). The fruits ripen and fall from May to September. Ninety percent of the fruits produced stay next to the parent tree. Approximately ten percent of the indigenous propagules are assumed to be invading new areas. Propagule mortality is a function of varying temperature and salinity. The mathematical function describing mortality due to temperature is a linear decrease from sixty-seven percent mortality at 36°C to zero mortality at 30°C:

$$M_T = (30 - T_A) (0.67/5) \quad (1)$$

where M_T is mortality due to T_A , the air temperature. The mortality due to salinity was approximated after Stern and Voigt (1959) where mortality increased from thirteen percent in sea water to forty-seven percent in tap water as follows:

$$M_S = (1 - S/45) (.5) \quad (2)$$

where M_S is the mortality due to salinity S which is in parts per thousand. All the dead propagules are transferred directly to detritus.

Living propagules all germinate and grow leaves, stems, and roots with a rate of growth as follows:

$$dG/dt = kG(G_{max} - G) \quad (\text{Salisbury and Ross, 1969}) \quad (3)$$

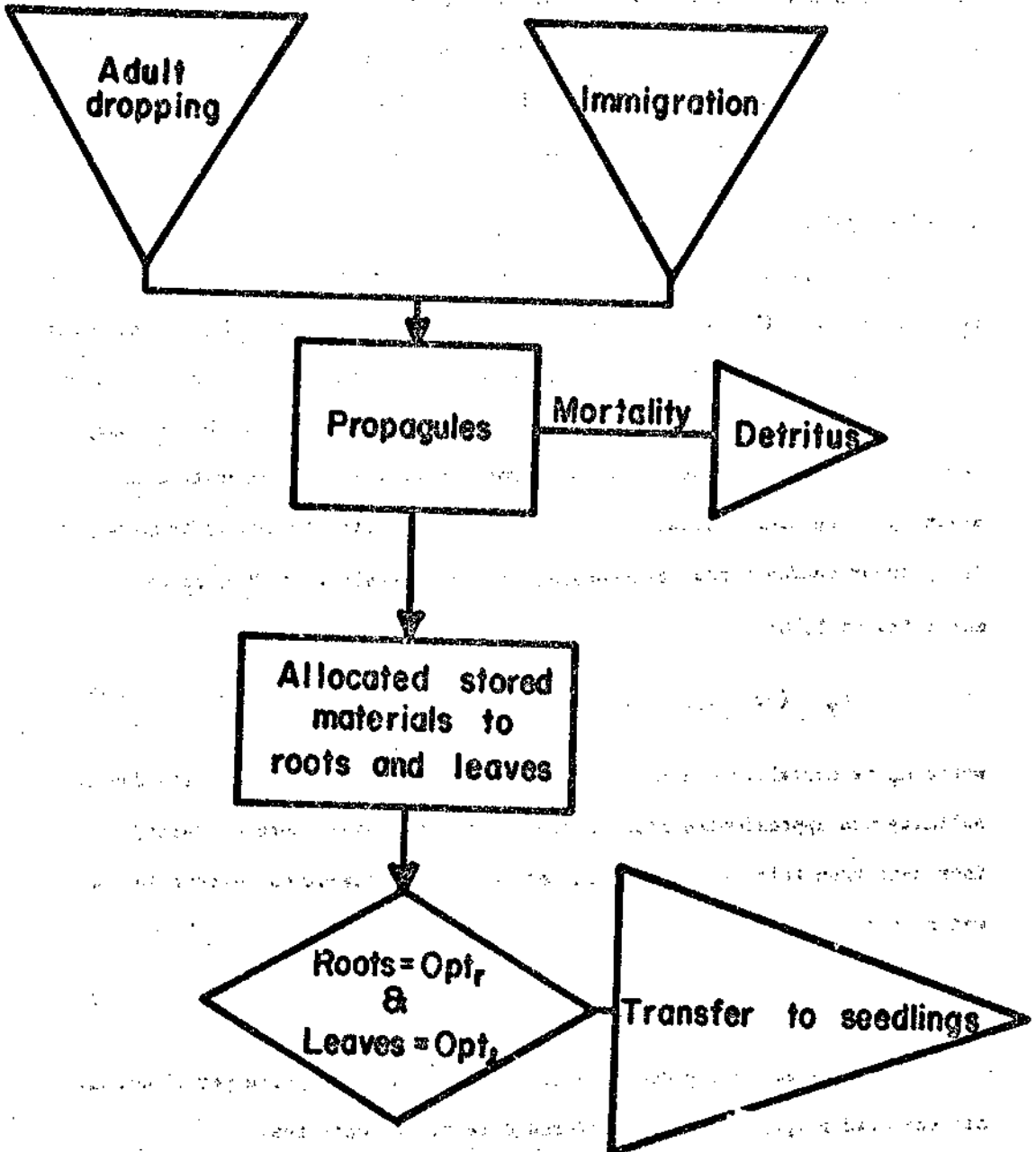

Figure 15 Propagules submodel flow chart

where dG/dt is the rate of growth, k is a time constant relating to the length of time taken to reach G_{max} which is the optimum biomass of the leaves, stems, or roots prior to the transfer to seedlings. G is the current biomass of the leaf, stem or root part in question. As a propagule only stored energy is used for growth. Optimum leaf, stem and root biomasses were calculated by taking the caloric values for propagules, leaves, stems, and roots (4.58, 4.18, 4.34, and 4.03 kcal per gram dry weight after Golley, 1969), converting to kilocalories per gram wet weight using a 0.4 dry to wet weight conversion factor, then dividing the propagule energy content by the weighted plant energy content assuming 0.22, 0.63, and 0.15 for leaf, stem, and root fractions respectively. This yields an estimate of propagule energy content after distribution according to seedling wet energy contents: i.e. the propagule will grow to 2.4 times its dormant biomass before needing outside energy input. After taking 2.4 times the propagule wet weight and subtracting expected respiration losses, we can estimate the leaf, stem, and root biomasses as 22, 63 and 15 percent respectively of the remainder. Once the optimum leaf, stem and root biomasses are attained the propagules are transferred to the seedling category.

III. Seedlings and Adults

Once a propagule has attained the seedling leaf-stem-root ratio, the growth scheme given in Figure 16 is followed. The life pattern in seedlings is assumed to be exactly the same as that of an adult therefore the same flow chart and subroutine are used with different initiating parameters. First solar energy enters the canopy and fifty percent is absorbed by the leaf material. Net photosynthesis is calculated after Gaastra (1963) as follows:

Figure 16 Seedling and adult submodel flow chart

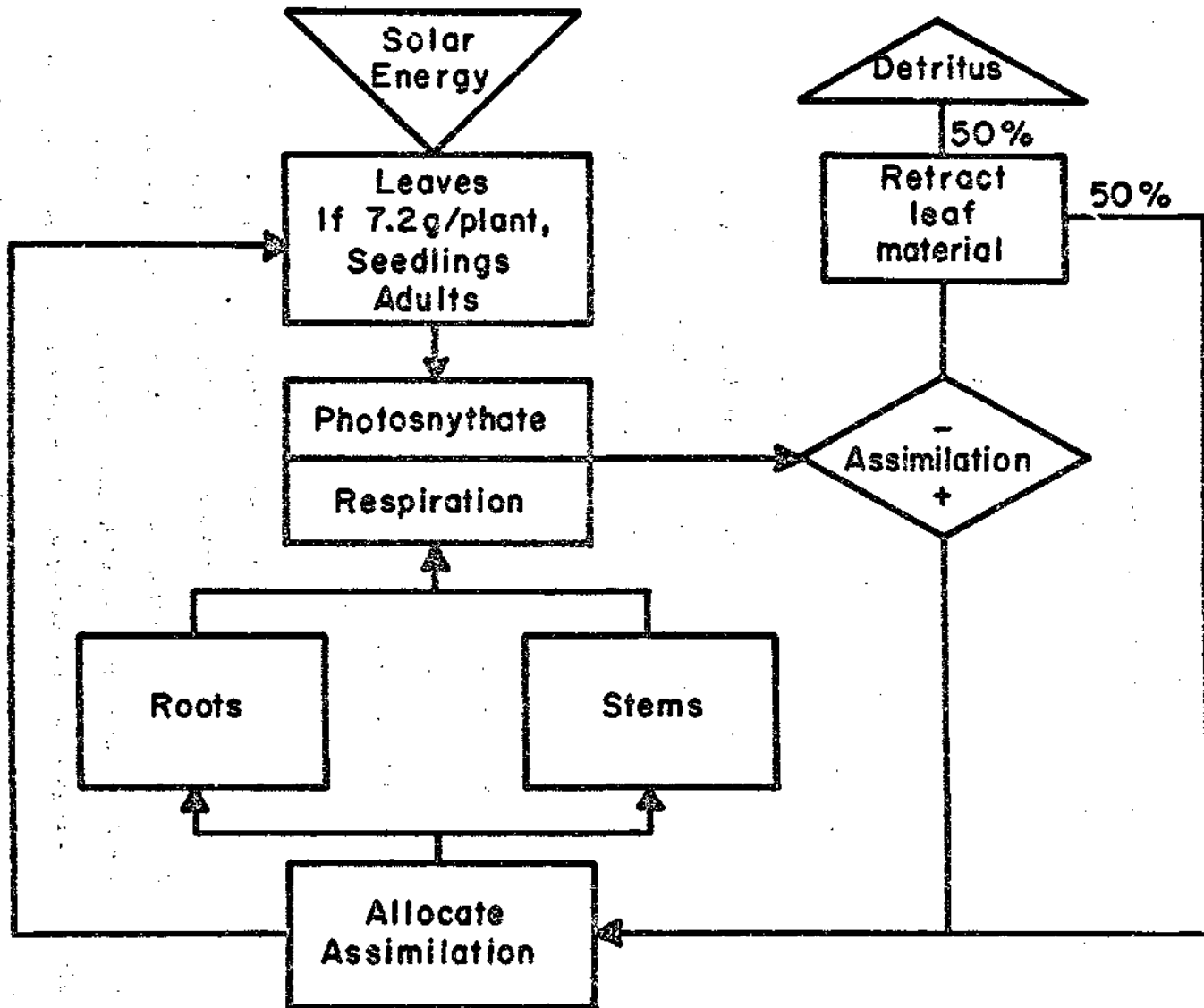

$$P_n = ([CO_2]_a - [CO_2]_l) / (1.56r_l + r_a + r_m) \quad (4)$$

where P_n is the net photosynthesis for LAI equal to 1.0, $[CO_2]_a$ and $[CO_2]_l$ are the carbon dioxide concentrations of the air and leaves, r_l is the leaf resistance to water loss, 1.56 is the ratio of the diffusion coefficients of carbon dioxide and water vapor, r_a is the laminar boundary layer resistance and r_m is the mesophyll resistance to carbon dioxide exchange. The leaf resistance to water loss is calculated using:

$$r_l = (0.5 - (0.0245) (WD \times SA) + (C \times WD \times SA)^{16}) / (1. + (16 \times SA))$$

(Miller and Ehringer, 1972) (5)

where WD is the water deficit, SA is solar absorbed, and C is a constant.

The net photosynthesis is then multiplied times the leaf area index then stem and root respiration is subtracted. The Gastra equation takes into account leaf respiration so only stem and root respirations are subtracted from the net photosynthesis. Respiration is calculated using the Q_{10} equation:

$$R = R_0 Q_{10}^{0.1(T - T_0)} \quad (6)$$

where R_0 and T_0 are reference respiration rate and temperature, respectively. Daily respiration was estimated directly from equation (6) where as daily net photosynthesis was a linear approximation from the instantaneous solar noon rate.

The light entering the canopy was extinguished exponentially:

$$SA = SA_0 e^{-k_A F} \quad (7)$$

where F is the leaf area index, and k_A is the extinction coefficient which is calculated as follows:

$$k_A = \cos(I) \quad (\text{Duncan, et al., 1967}) \quad (8)$$

where I is the leaf inclination from horizontal. Dynamic strata were used to correct for reduced photosynthesis with the extinction of light through the canopy. It has been noted that the leaf angle used in equation (8) decreases from the top to the bottom in an adult canopy (Miller, 1972). Miller (1972) has also measured the leaf areas for various mangrove canopy strata and given a typical tree distribution for both leaf inclination and leaf area. Given the typical leaf area and leaf angle distribution for adult trees one can distribute a total leaf area index accordingly yielding a corresponding reduction of light for lower levels in the canopy. This process limits the size of the canopy in the following way. In the model if a stratum has a negative production, respiration exceeds photosynthesis for the stratum, then the stratum leaf biomass is reduced accordingly, also the stratum does not receive new material for growth. The lower levels are then reduced as the leaf area index exceeds the value at which all strata sustain zero to positive production. This yields an optimum leaf area index and maximum tree size which maximizes production.

Once daily photosynthesis is calculated it is reduced according to the temperature function described in the accompanying paper. Zero efficiency occurs at 25°C with a linear decrease from 25°C to 15°C and 25°C to 35°C such that at 15°C or lower or 35°C or higher photosynthesis does not occur.

Assimilation is then the difference between respiration and net photosynthesis. If the daily assimilation is negative, leaf material is lost at a rate of twice the negative assimilation assuming fifty percent efficiency in the resorption. Fifty percent of the retracted leaf material goes to maintenance of the plant while fifty percent is transferred to detritus. If net photosynthesis is positive then it is allocated as follows:

$$F_i = 2(OF_i) - CF_i \quad (9)$$

where F_i is the fraction allocated to the i^{th} plant part, OF_i is the optimum fraction of the i^{th} plant part and CF_i is the current fraction of plant material residing in the i^{th} plant part. OF values for leaves, stems, and roots are 0.085, 0.610, and 0.310 for adults and 0.22, 0.63, and 0.15 for seedlings.

The seedling to adult transfer occurs at 7.2 grams of leaf material per plant. When this arbitrary leaf biomass is reached the seedling is then considered an adult. This weight standard corresponds to the weight of four mature leaves.

IV. Fruit Production

The fruit production scheme was designed from qualitative descriptions of red mangroves on the Rung Sat Delta. Fruiting begins in March with peak production from May to July with a steady decrease from July to August. Fruit production ceases in August. These observations were incorporated in the model as a discontinuous function as follows:

$$\text{March to May} \quad F_f = (D/30) \times 0.5 \text{ MK} \quad (10)$$

$$\text{May to July} \quad F_f = \text{MK} \quad (11)$$

$$\text{July to August} \quad F_f = \text{MK} - D/30 \quad (12)$$

where F_f is the fraction of leaf material available for growth allocated to fruit production, D is the current day of the month and MK is the maximum fraction of net production allocated to fruit production. From January to March and from August to December F_f is set to zero. The MK value was arbitrarily set to fifty percent of leaf material available for growth.

V. Detritus, Nutrients, and Herbicide

All dead material is added to detritus which is undergoing a tidal exportation of 87.4 percent (Colley et al. 1962) and exponential decay:

$$D = da^{-k_1 t} \quad (13)$$

where D is the current weight in grams of detritus, d is the initial weight in grams of detritus, t is time lapse from initiation in days, and k_1 is 6.7×10^{-3} which is the decay constant associated with forty-five percent decomposition in two months (meetings on mangrove ecology, 1972).

A fraction of decomposed detritus is then allocated to nutrients and herbicide in solution. Thirty-five percent of decomposed detritus is assumed to be nutrients with 0.05 percent being assumed herbicide if the plant death is a result of herbicide introduction. Nutrients and herbicide in solution then undergo exponential decay as follows:

$$N = na^{-k_2 t} \quad (14)$$

$$H = ha^{-k_3 t} \quad (15)$$

where N is the current nutrient concentration, a is the initial nutrient concentration, k_2 is the decay constant relating decay exponentially to time, H is the current herbicide concentration, h is the initial herbicide concentration, and k_3 is the decay constant relating decay exponentially to time. It is assumed that 87.4 percent of the nutrients and herbicide in solution is exported with tidal inundation periodically.

If the herbicide concentration is above 10 lbs per acre or 11.2×10^3 gr. per hectare defoliation occurs and all the leaf material is transferred to detritus. (meetings on mangrove ecology, 1972).

Evaluation of Data Base and Estimation of Parameters

There are few data available regarding propagule and seedling growth. To determine an estimate of the leaf-stem-root fractions for seedlings two submodels were proposed using (1) the typical adult leaf-stem-root fraction indicated by Golley *et al.*, (1962) and (2) a linear projection of the Golley data to approximate seedling leaf-stem-root fractions. If the plant part biomasses for leaves, stems, and roots are reduced to fraction of the total biomass and plotted versus the diameter at breast height clear trends are indicated for leaves and roots. Projecting these trends to zero diameter at breast height yields 0.22 and 0.15 for leaf and root fractions. This procedure was done by hand and the leaf and root fraction appear to be a curvilinear function of diameter at breast height so the indicated values are crude estimates. With 0.22 for the leaf fraction and 0.15 for the root fraction we have 0.63 for the stem fraction. Submodel (1) resulted in a quick elimination of seedlings under a leaf area index of 1.0 and 3.0, and zero maturation to the adult categories under a leaf area index of zero. Submodel (2) indicated four year survival under a leaf area index of 1.0 and maturation to the adult category in three years under a leaf area index of zero.

In determining the root fractions an approximation was used correcting the Puerto Rican data (Golley *et al.*, 1962) for subsurface roots. Snedacker and Lugo (1972) indicated subsurface roots as thirty-six percent of the prop-root-subsurface root subtotal. All of the prop-root biomasses indicated by Golley were then divided by 0.63 to include an estimate of the addition due to subsurface roots.

Correcting the leaf-stem-root fractions indicated by Golley *et al.*, (1962) at 2.8 cm. diameter at breast height we have adult fractions of 0.085, 0.610,

and 0.305 for leaves, stems, and roots respectively. These values were used to characterize the typical adult plant in the model.

Two fruiting submodels were proposed: (1) a fraction of the assimilation allocated to leaf production was used for fruit production, and (2) a fraction of the total assimilation was used for fruit production. With submodel (2) fruits averaged ten percent at maturation of the total adult biomass. Submodel (1) indicated fruits between 1.5 and 3.1 percent at maturation of the total adult biomass. Snedacker and Lugo (1972) found between 0.0 and 4.1 percent residing fruits in their studies of red mangroves.

To determine seedling density for estimating the leaf biomass per plant the above ground dry weight at the end of five months growth was divided by 1.77 grams which is the above ground dry weight of five month old seedlings as indicated by Stern and Voigt (1959). With an immigration of 3.0 grams of propagule a year this yields a first year density of 1.1 seedlings per meter squared. Typical assimilation data for this density are given in Table 8.

Results

The effects due to temperature are demonstrated in Figure 17. Three twenty year simulations were made with (1) normal temperatures, (2) half degree above normal temperatures and (3) a full degree above normal temperatures. Simulation (2) and (3) showed eighteen and forty-eight percent decreases in biomass below the biomass of simulation (1).

The effects due to salinity were less dramatic. Three twenty year simulations were made using (1) the normal salinities for brackish water, (2) one part per thousand above normal salinities for brackish water and (3) two parts per thousand above normal salinities for brackish water. There was less than one percent variation in total biomass between the three simulations.

Table 8. Net photosynthesis, total respiration and plant assimilation in grams organic matter per meter squared per day are given for various growth stages with no overhead light extinction for seedlings of density 1.1 and adults of variable densities.

Months After Defoliation	Leaf Biomass	Photosynthesis	Respiration	Assimilation
5 months	1.2	0.021	0.004	0.017
17 months	3.6	0.066	0.012	0.054
29 months	10.3	0.187	0.034	0.152
Years After Defoliation				
5 years	19.1	0.334	0.104	0.230
7 years	39.6	0.675	0.315	0.359
9 years	51.3	0.856	0.554	0.301
11 years	78.8	1.220	0.790	0.430

Figure 17 Total mangrove biomass with temperature variations

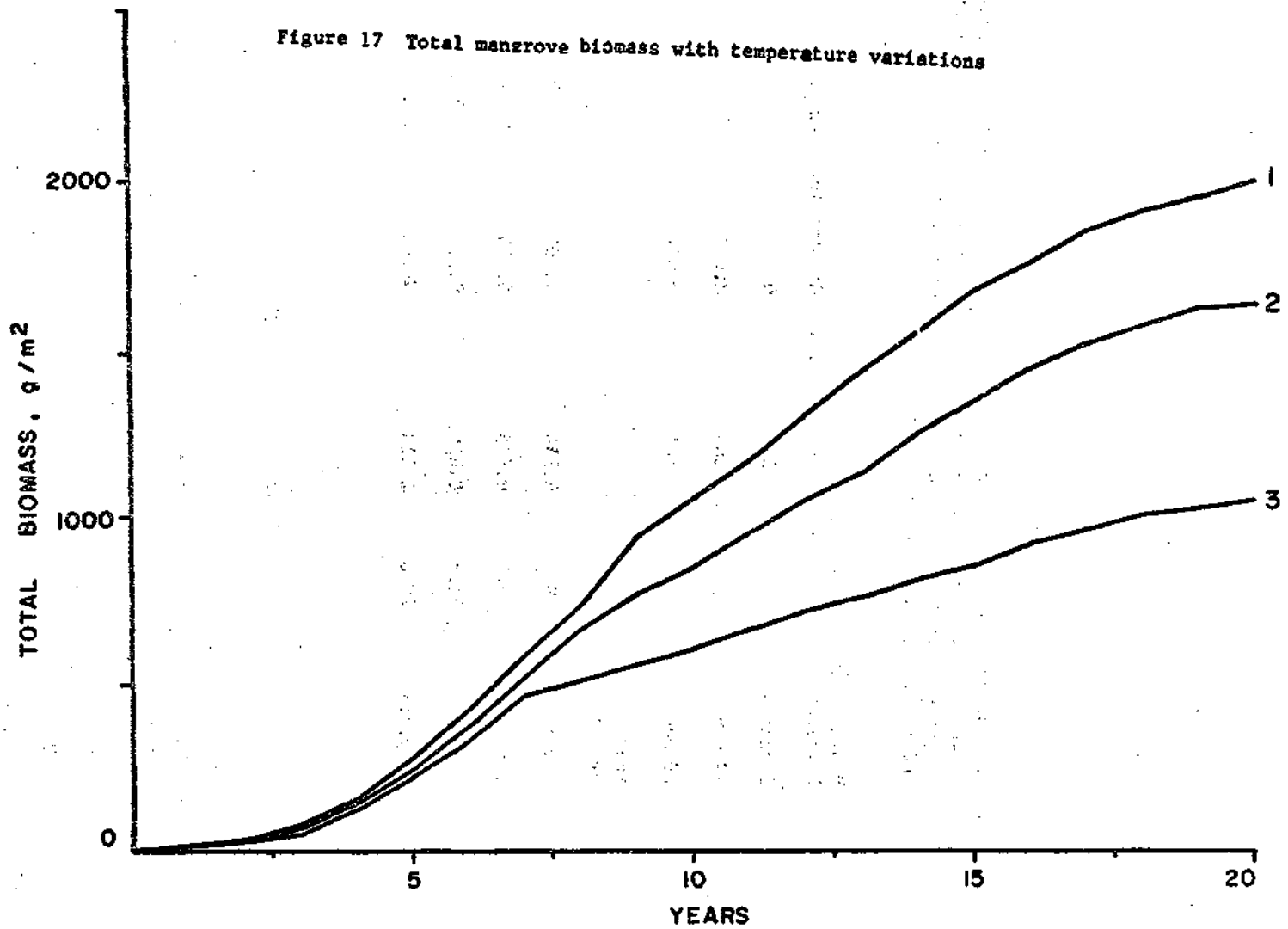

Variations of reforestation due to varying immigration are shown in Figure 18. Three twenty year simulations were made using immigration rates of (1) 1.0 grams, (2) 2.0 grams and (3) 3.0 grams of propagule per meter squared per year. Simulations (1) and (2) showed twelve and nine percent decreases in biomass below the biomass of simulation (3).

Conclusion

The effects due to increased salinity appear to be relatively small. The effects of temperature play a major role in reforestation. The barren nature of the Rung Sat Delta due to defoliation and wood gathering has increased the likelihood of temperatures inhibitory to plant growth. Inhibitory temperatures and slow immigration are the major sources of inhibition in the model and in combination probably play the major role in reforestation problems on the Rung Sat Delta.

The most critical deficiency is the lack of data on the growth habits of propagules and seedlings. The nature of initial rooting and the role of solar radiation in activating propagules on the mud are unknown. Data are available on five month old seedlings and adults of unknown ages. There are data concerning adult photosynthesis, respiration, canopy structure and root structure but no intermediate points for seedlings and younger adults which would serve to improve and validate the model.

Figure 18 Total mangrove biomass with immigration variations

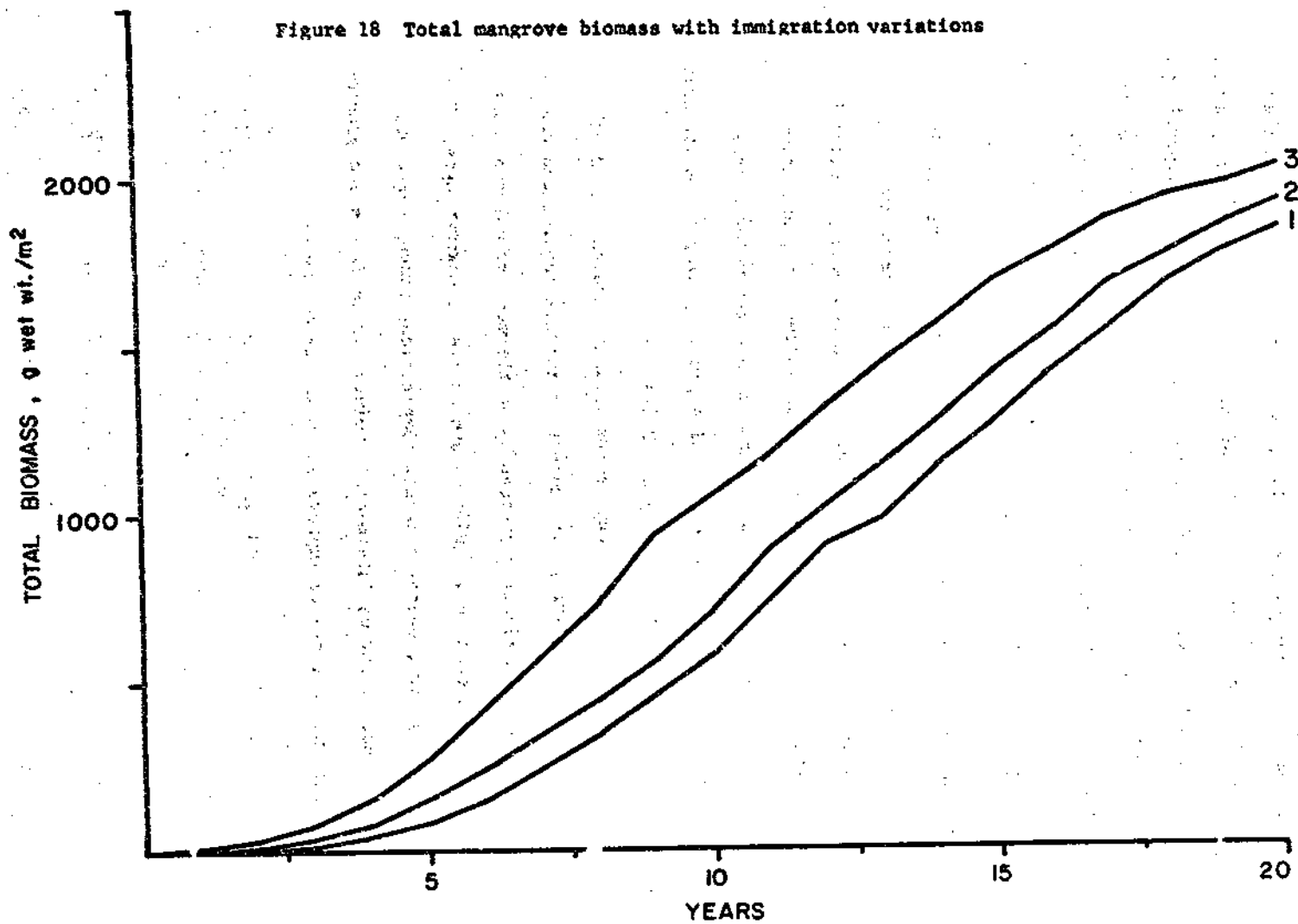

LITERATURE CITED

- Conway, H. 1963. *The Weather Handbook*. Conway Publications Inc., Atlanta. 255 pp.
- Cuong, Humbert Vu Van. 1964. *Flore et Vegetation de la mangrove*. These de docteur, Universite de Paris.
- Dept. of Commerce. 1968. Viet Nam solar radiation data for the period January, 1964 through October, 1967. Environmental Data Service, National Climate Center, Asheville, North Carolina.
- Duncan, W. G., R. S. Loomis, W. A. Williams, and R. Manai. 1967. A model for simulating photosynthesis in plant communities. *Hilgardia* 38.
- Gaastra, P. 1963. Climatic control of photosynthesis and respiration. In L. T. Evans (ed.) *Environmental Control of Plant Growth*. Academic Press, New York.
- Golley, F. B. 1969. Caloric values of wet tropical forest vegetation. *Ecology* 50 (3): 517-519.
- Golley, F. B. 1971. *Effect of Defoliation on Mangroves*. Report to the National Res. Council Committee on the use of Herbicides in Viet Nam. 18 pp. Mimeo.
- Golley, F., H. T. Odum, and R. F. Wilson. 1962. The structure and metabolism of a Puerto Rican mangrove forest in May. *Ecology* 43: 9-19.
- Heald, E. 1971. The production of organic detritus in a south Florida estuary. Univ. of Miami, Coral Gables. Sea Grant Tech. Bull. 6.
- Miller, P. C. 1972a. Bioclimate, leaf temperature, and primary production in red mangrove canopies in south florida. *Ecology* 53: 22-45.
- Miller, P. C. 1972b. A test of radiation models in vegetation canopies. Submitted to *J. Appl. Meteorol.*
- Miller, P. C. 1972c. Investigations of physical processes affecting leaf temperature profiles and primary production in the red mangrove ecosystem. Progress Report. AEC Contract AT (04-3)-807.

- Miller, P. C. and J. Ehleringer. 1972. Comparison of leaf resistances to water loss and leaf water relations in three mangrove species in south Florida. Ecology (in review).
- Miller, P. C. and L. Tieszen. 1972. A preliminary model of processes affecting primary production in the arctic tundra. Arctic and Alpine Res. 4: 1-18.
- Monteith, J. L. 1965. Light distribution and photosynthesis in field crops. Ann. Bot. N.S. 19: 17-37.
- Moore, R. T., P. C. Miller, D. Albright, and L. Tieszen. 1972. Comparative gas exchange characteristics of three mangrove species during the winter. Photosynthetica (in press).
- Salisbury, F. B. and C. Ross. 1969. Growth and problems of morphogenesis. 407-438 pp. In Plant Physiology. Wadsworth Company, California.
- Snedacker, S. C. and A. E. Lugo. Center for Aquatic Sciences. The role of mangrove ecosystems in the maintenance of environmental quality and a high productivity of desirable fisheries. Bureau of Sport Fisheries and Wildlife 14-16-008-606 Annual Report FY 71-72.
- Stern, W. L. and G. K. Voight. 1959. The effects of salt concentration on growth of red mangroves in culture. Bot. Gazette 121(1): 36-39.
- Tschirley, F. H. 1969. Defoliation in Viet Nam. Science 163: 779-786.
- Waggoner, P. E. and W. E. Reifsnyder. 1968. Simulation of the temperature, humidity, and evaporation profiles in a leaf canopy. J. Appl. Meteor. 7: 400-409.
- Zinke, P. 1972. Report on a reconnaissance of the soil fertility aspects of chemical defoliants in South Viet Nam. Report to the Committee on the use of Herbicides in Viet Nam.

**6. Ordering and Disorder in South Vietnam
by Energy Calculation**

Mark Brown

Studies stimulated by a contract between the National Academy of Sciences and the Department of Environmental Engineering Sciences, University of Florida, Gainesville, for "Models of Herbicide and War in Vietnam".

Central to understanding the relationship of countries and their balance of Man and Environments are the flows of energy that maintain order, the disorder created in the normal cycle maintaining order, and the effects of war. This paper considers order and disorder relationships in South Vietnam as a result of the War from 1960 to 1972. An investigation of effects of herbicides was undertaken, as a series of projects, by the National Academy of Sciences. This paper is an outgrowth of concepts developed while formulating a model of main energy flows in Vietnam.

The investigation of the ecological and physiological effects of the defoliation and crop destruction programs in South Vietnam included an evaluation of the herbicide agents and their relationship to other means of disordering and the combined effects of disordering activity on the natural ecological and man-made technological systems of the country. While it is apparent that the goals of the defoliation programs were to reduce the ground cover and limit the ability of the North Vietnam and Viet Cong military structure to use the structure of the natural environment to their advantage, these goals have left the country of South Vietnam with problems. Large amounts of South Vietnamese lands were altered and moved from one form of land use to others, resulting in measurable changes to the processes of the country. Understanding the immediate effects of such a program and the long range effects and interactions may require an overview that also takes into account time delays, feedback operations, and secondary interactions. One technique for over-viewing is a drawing of a systems diagram.

A Model of Vietnam

Figure 1 is a diagram of the country of South Vietnam at war. It shows the compartments and flows of energy and materials throughout the country. The circles to the left represent forcing functions or the Ordering Energies available to South Vietnam. S_1 is all incoming goods, both United States aid and imported goods from the World Market. S_7 is all money sent to South Vietnam in the form of aid; and S_6 is all the natural energies (sun, tides, wind, rain, etc.) available to the country. The circles to the right represent the Disordering Energies that are forcing functions for the country at war. S_2 is all the energies available to the Viet Cong and North Vietnamese military structure to make war. S_3, S_4, S_5 are the three major disordering energies of the U.S. and South Vietnam military structure.

The land categories (city, agriculture, forest and mangrove) are each separated into their respective components (or storages). The city system has within it land, people, goods, and a storage of money. The natural systems have two components each: land and structure. The land storage and the forcing function interact to produce structure.

The components to the right of the natural systems, those of craters, base land, bare land, and dead wood, are components that are storing the disordered land and structure as it is transferred from one land use category to another by the impact of the disordering energies.

In Fig. 1, the rates of material and energy flows, and the quantities stored in each of the components of the country have been calculated for the year 1965; the beginning of the escalation of the United States involvement in Indochina War. (Calculations and sources for the calculations are summarized in Appendix A.) Evaluation of the flows of disordering energies gives perspective to their effects on the many processes of the country. Consider the quantities of land and structure removed from each of the land use cate-

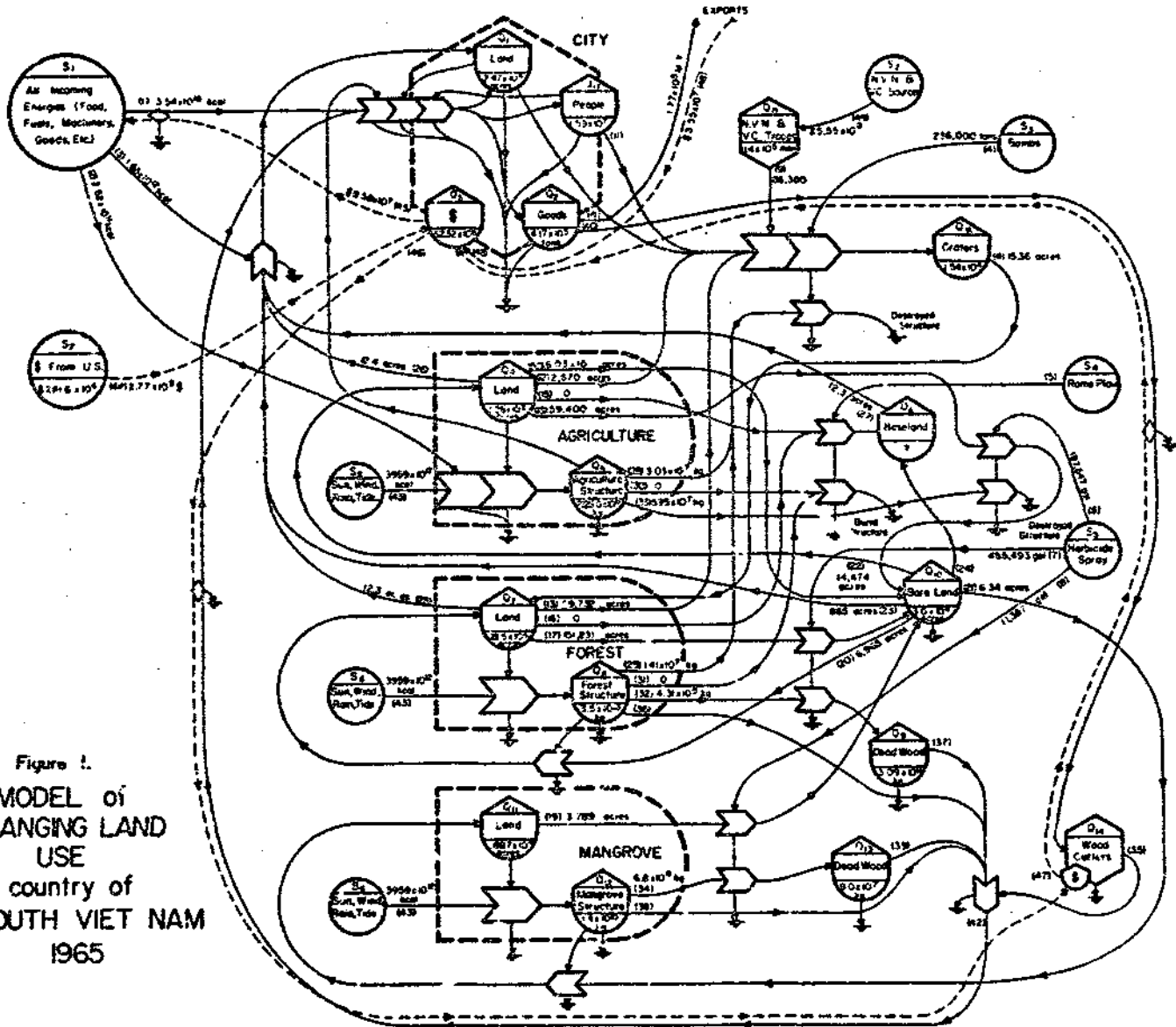

Figure 1.
 MODEL of
 CHANGING LAND
 USE
 for country of
 SOUTH VIET NAM
 1965

gories by bombs and herbicides; in all cases herbicides account for the greatest disordering, an effect that reverses through the course of the six year period from 1965 to 1970.

Another method of understanding the effects that the disordering energies have had on the processes of the country is to calculate the disrupted portions of the energy budget of South Vietnam. The overall effects on the energy budget are summarized in Table 1. Column 1 in Table 1 shows the average energy budget (ordering energies) per year for the six year period, 1965-1970. column two shows the cumulative budget for all six years. Columns three, four, and five show the total amounts of Disordered Energy due to each of the disordering operations of Bombing, Herbicides, and Rome Plowing as best they can be calculated. Column six shows the percentage of the energy budget that was disrupted for each of the various subsystems of the country.

During the six year period of major United States involvement in the Indochina War (1965-1970), 3.1% of the total energy budget of South Vietnam was disrupted. If comparisons can be drawn between the man-made world as various systems and the natural ecological systems of the biosphere, then a disruption of this magnitude, by itself, will probably have little effect on the overall processes of the country.

Table 1. Comparison of Disordered Energy

	Average Energy Budget	(7) Cumulative Energy Budget 1965-1970	(8) Disordered Energy BOMBS	(9) Disordered Energy HERBICIDES	(10) Disordered Energy ROME PLOW	% of Energy Budget Disordered
	10 ¹² kcal/yr	10 ¹² kcal	kcal 10 ¹²	kcal 10 ¹²	kcal 10 ¹²	
Human Settlements	19.4 (1)	116.4	9.1 ^a	4.9 ^a	---	12.9%
Agriculture Systems	112.0 (2)	672.00	24.33	8.78	1.55	5.2%
Forest Systems	1110.0 (3)	6660.0	303.14	179.4	40.6	7.9%
Mangrove Systems	61.0 (4)	366.0	12.55	136.1		40.6%
Estuarine Systems	29.0 (5)	174.0	.24	9.0		5.3%
Other Nat. Energies	2647.0 (6)	15882.0	?	?	?	?
TOTAL	3978.4	23870.4	349.36	338.18	42.15	3.1%

* City land disordered by bombs and herbicides was 8.7% and 4.2% respectively. It was then assumed that an equal percentage of the total energy budget was disrupted..

1. The sum of purchased goods, foreign aid, and fuel. Purchased goods and foreign aid were 2.6×10^8 \$ and 5.1×10^8 respectively multiplied by 1.4×10^4 kcal/dollar to convert to equivalent fossil fuel energies required to generate the same work, (10.7×10^{12} kcal). Add to this, fuel (8.66×10^5 metric tons) (10^6 grams/ton)(10 kcal/gram) = 8.66×10^{12} . $10.7 \times 10^{12} + 8.66 \times 10^{12} = 19.4 \times 10^{12}$ kcal.

2. The chemical potential energy entering the system as agriculture production was estimated by multiplying the land area in agriculture (7.31×10^6 acres) by the estimated gross photosynthesis (1.6×10^5 kcal/acre/day) and then by 100 days.

3. The chemical potential energy entering the system as gross photosynthesis of inland forests was estimated by multiplying the land area (1.9×10^7 acres) by the estimated gross photosynthesis (1.6×10^5 kcal/acre/day) and then by 365 days.

4. The chemical potential energy entering the system as gross photosynthesis of mangrove systems was estimated by multiplying the area ($.69 \times 10^6$ acres) by the estimated gross photosynthesis (2.4×10^5 kcal/acre/day) and then by 365 days.

5. The chemical potential energy entering the system as gross photosynthesis of estuarine systems was estimated by multiplying the area (1.0×10^6 acres) by the estimated gross photosynthesis (8.0×10^4 kcal/m²/day) and then by 365 days.

6. The sum of the natural potential energies of: Rivers (644×10^{12} kcal/yr), Tides (152×10^{12} kcal/yr), Rain as Runoff (119×10^{12} kcal/yr). See Odum, "Effects of Herbicides on Ecosystems."

7. Cumulative energy budget was calculated as the maximum possible, assuming there was no disordered land. It was calculated by multiplying the average energy budget times the time span (6 years).

8. Disordered energy by bombs was calculated by multiplying the land area disordered each year from 1965 to 1970 by the estimated gross production, and

then by the number of years remaining in the six year period. (See Appendix B for year by year breakdown.)

9. Disordered energy by herbicides was calculated by multiplying the land area disordered each year from 1965 to 1970 by the estimated gross production and then by the number of years remaining in the six year period, except agriculture sprayed assumed only one year loss. (See Appendix B for year by year breakdown).

10. Disordered energy by Rome plowing was calculated by multiplying the land area disordered each year from 1965 to 1970 by the estimated gross production and then by the number of years remaining in the six year period, except agriculture plowed assumed only one year loss. (See Appendix B for year by year breakdown).

Order and Disorder in Vietnam

It is well known that many ecological systems are stress adapted and to a certain extent even depend on some form of stress to speed up processes and recycle nutrients. Just as the fire-climax forests and prairies are stress adapted, and depend on pulses of brush fire to recycle nutrients; the country of South Vietnam could possibly be considered a stress adapted system. Conflict, and large-scale warfare have been the rule rather than the exception since the Geneva Agreements of 1954 and even before with a long and bitter conflict between the Communist led Vietminh and the French armed forces. Frequent stress, such as grassland, grazing, rather than a pulse stress results in greater overall production by reducing diversity and releasing disordered materials for reconstruction and repair. Could the same apply to a 30-year war and the country of South Vietnam?

The six year involvement of the United States in the Indochina War resulted in an escalation of disordering energies which could represent an additional pulse stress of 3.1%. Far more important than the magnitude of this overall stress are the percentages of the energy budgets that were disrupted from each of the subsystems of South Vietnam. Column 6 in Table 1 lists the percentages of each subsystem disordered. A comparison of these indicates that while the country had a 6 year pulse stress of 3.1%, individual stresses account for major effects, and due to secondary interactions may magnify this overall stress.

The mangrove systems were stressed nearly 41%; a stress that would reduce the ability of the system to recover in a short period of time. Data gathered by NAS personnel while surveying ecological effects of herbicides in Vietnam indicate a lack of recovery, possibly due to loss of seed source. It has been suggested recently that mangrove systems are an important part of the food chain in estuarine systems. A stress of this magnitude could have severe effects on estuarine systems that, in turn, will affect the human settlements by a loss of

food source.

The forest systems of the country were disordered nearly 8%; a stress that will probably have little effect on the individual system, but if time delays and secondary interactions are taken into account, then those systems depending on the forest systems as an auxiliary energy source (the human settlements) will feel the stress far more than the initial system.

The human settlements of South Vietnam had 13% of their energy budget disordered during the six year period (1965-1970). Add to this the effects of increased population due to relocation of refugees, reduced agriculture production (5.2%), reduced estuarine production, and reduced forest production, and again the direct stress is magnified requiring many years to recover.

Another way of showing these same effects for the purposes of comparison to other flows of energy throughout the country is the systems diagram. Figure 2 is an energy diagram of the gross energy budget for the country of South Vietnam showing all the main energy flows, constructive and destructive, those of nature, and those of the cities. Energy of low quality such as sunlight is expressed in the chemical potential energy after transformation by photosynthesis. The flows of high quality energy such as the urban technological economy are expressed in equivalent fossil fuel energy required to generate the same work.

When many of the details of small component flows of energy through the country, such as in Figure 1, are eliminated by retreating to a more macro-scale view, certain patterns, or consequences of the war become more obvious, and comparisons can be drawn. For instance, the ratio of the destructive energies of war (disordering energies) to the constructive energies of nature, and the cities is approximately 1 to 17, or the disorder to order ratio is 6.0%.

Ewel (1971) described five tropical environments disrupted with a disorder to order ratio of 3.8% showing initial decreases in primary production, but long run rejuvenation. Richey (1970) tested a disorder to order ratio of 8.0% by burning microcosms; again showing initial decreases in production; but

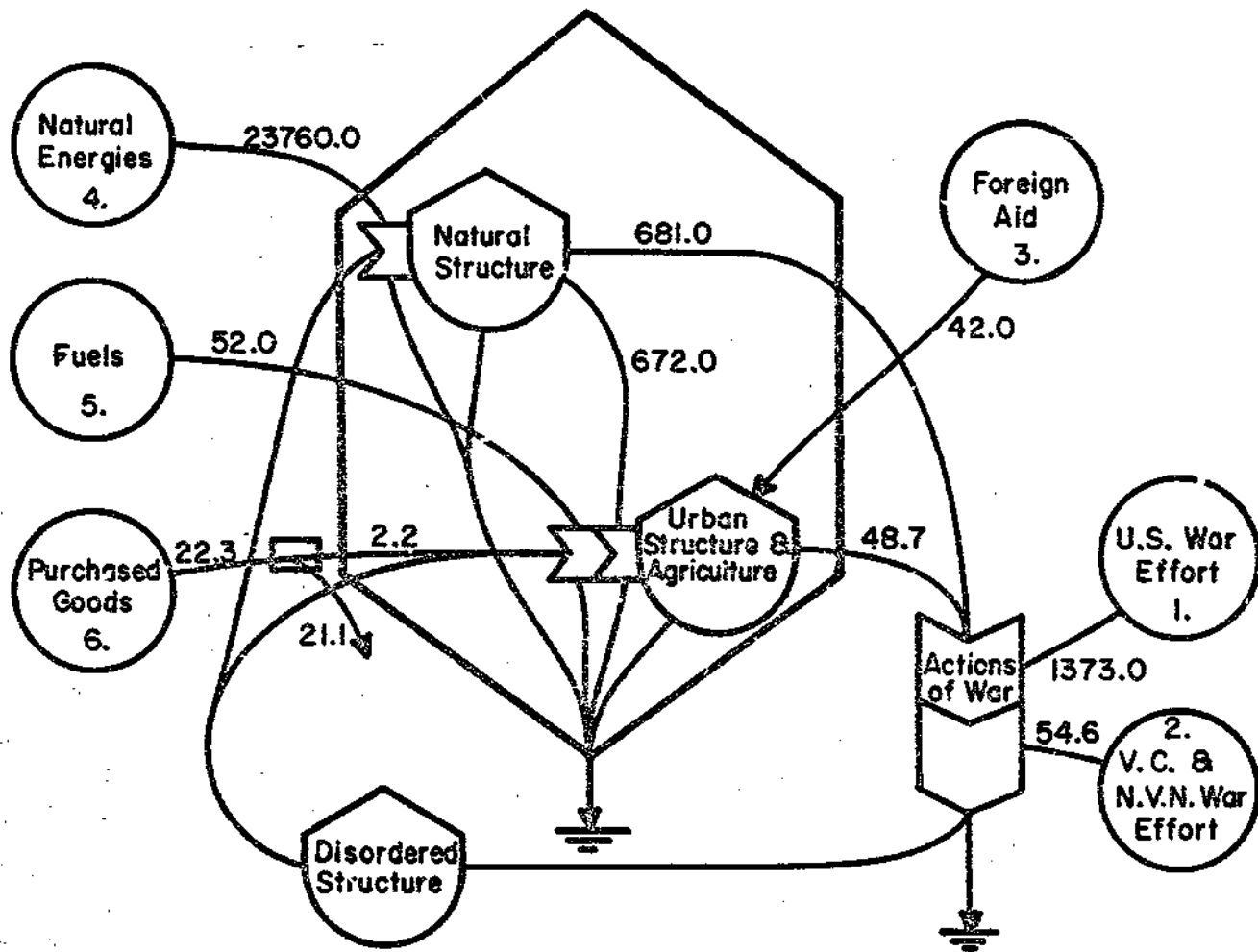

all values: 10^{12} kcal / 6 years

Figure 2: Energy Budget of South Vietnam, 1965-1970.

Notes on Figure 2.

1. U.S. war effort was calculated by adding the incremental costs of the war in Vietnam for the years 1965-1970. The incremental costs are the costs which represent the "net difference between wartime and peacetime needs." (U.S. Congress. House Committee on Appropriations. Dept. of Defense: Appropriations for 1970 pt. VII. Hearings, Washington, U.S. Government Printing Office, 1970, p. 395). The total war effort (9181×10^{10} dollars) was then multiplied by 1.4×10^4 kcal/dollar to obtain the energy expenditure.

2. Viet Cong and North Vietnamese war effort was estimated by assuming steady increase from \$555 million (Thayer, 1969) to \$765 million in 1970 (A.P.), Gainesville Sun, Gainesville, Florida. April 2, 1972). The total war effort (3.9×10^9 dollars) was then multiplied by 1.4×10^4 kcal/dollar to obtain the energy expenditure.

3. U.S. Aid was calculated by adding the official aid for the years 1965-1970. (Annual Statistical Bulletin, No. 14.) the Official Aid (3.03×10^9 dollars) was then multiplied by 1.4×10^4 kcal/dollar to convert to potential energy entering the system.

4. Natural Energies are all those energies entering the country from the chemical potential energies of gross photosynthesis of ecosystems, and the chemical potential energies of rivers, tides, thermal heating, winds, and rains as runoff.

5. Fuel inputs are from "Vietnam Statistical Yearbook." For the 6-year period 0.2×10^6 metric tons, this was multiplied by 10^6 grams/metric ton and by 10 kcal/gram to convert to calories of work.

6. Purchased goods was calculated by adding the import arrivals from Annual Statistical Bulletin No. 14 for the years 1965-1970. The import arrivals (1.59×10^9 U.S. dollars) was then multiplied by 1.4×10^4 kcal/dollar to convert dollars to the potential energy equivalent. Here it is assumed that 1/10 this amount is the energy value to the system, the remaining 9/10 is the cost of

manufacture and transportation. The calculation of energies was based on raw chemical potential energy conversion of each of the flows. There are studies currently underway to give certain "qualities" to energy to allow for more complete accuracy of calculation for modelling purposes. For example the "energy value" of a material or energy in a system is not only the measurable quantity of that flow, but has been suggested to be the initial energetic costs of processing and manufacturing as well.

recovery, and in some instances increases with time. Thus if comparisons can be drawn between the smaller scale systems of microcosms and individual ecosystems and the larger scale system of a country made up of many smaller subsystems, the impact of a pulse disorder to order ratio of 6.0% will probably release material and increase repair mechanisms required for rejuvenation, thus having a greater gross production with time. However, this does not indicate a stronger or more stable system for the higher gross production is achieved at a cost to diversity.

During this same 6 year period the disordering energies were 12 times as great as the flows of ordering energy due to foreign aid and purchased goods and fuel. Aid was over half that of purchased goods and fuel indicating a subsidized economy, an economy dependent upon increasing flows of high quality energy in a world where these flows are becoming limited.

But more important, the diagram shows where the most stress was inflicted by the actions of war. The natural system, while having a large loss in comparison to the urban energies disordered, was stressed 2.7%. The urban system (manbuilt-technological economy) had 7.0% of its incoming energies disordered. Other consequences of the war (secondary interactions) such as the shift in population from rural areas to the urban centers, the loss of population as casualties of war, and shifts in land use, have magnified this stress.

These calculations begin to show a more complete picture of the disordering of South Vietnam and some conjectures can be made. As a consequence of prolonged conflict and war the country of South Vietnam has become a stress adapted system decreasing diversity, and maintaining a low successional state. If, again, comparisons can be drawn between man built technological systems and natural ecosystems, then the country of South Vietnam can be considered a pulse-climax nation, such like the fire-climax forests and prairies, which, require large flows of energy and materials for reconstruction and rejuvenation after disordering, and thus maintain low diversity. As long as the disordering effects of the

conflicts remain, it is reasonable to assume that the country of South Vietnam will remain an unstable system.

Simulation Model of Vietnam

The disordering of lands and the accompanying transfer from one land use category to another might not be a "bad consequence" of the war; but in the long run, by those who advocate increased agricultural production for the country. For example, the change from forest to bare land has accomplished the first step in the process of bringing more land into agricultural production. This seems to be the case, as long as there are the necessary energies (U.S. Aid) available that can be added to the country's own reserves to accomplish this goal. However, there are short term losses that disordering vast amounts of forest, cropland, and urban systems must necessarily bring.

The actions of war have disordering effects on not only the physical, natural and man-made systems, but on the social and economic systems as well. As a consequence of the war there has been a massive switch from a rural to an urban population. With the help of U.S. Aid this shift in population has caused the urban centers to expand at an ever increasing rate.

The effects the disordering energies have had on the country of South Vietnam can only be assessed through time. The use of the systems diagram translated into the language of the analog computer and simulated gives new insight to the cumulative effects of all disordering energies. Figure 3 is a simplified version for the purposes of simulation, of the changing land use model in Figure 1. This diagram shows the action of war accelerating the recycling and reuse of disordered lands and materials. These are all parts that when fed back with an accompanying energy input, are available for and stimulate reconstruction. Evaluation of the rates gives a perspective of those changes that are important and computer simulations are used to show the cumulative effects on South Vietnam's energy budget as well as the costs of reordering.

Calculations and sources of information for the Rates of Flows and the storages in Figure 3 are summarized in Appendix C. War Effort (W) and United States

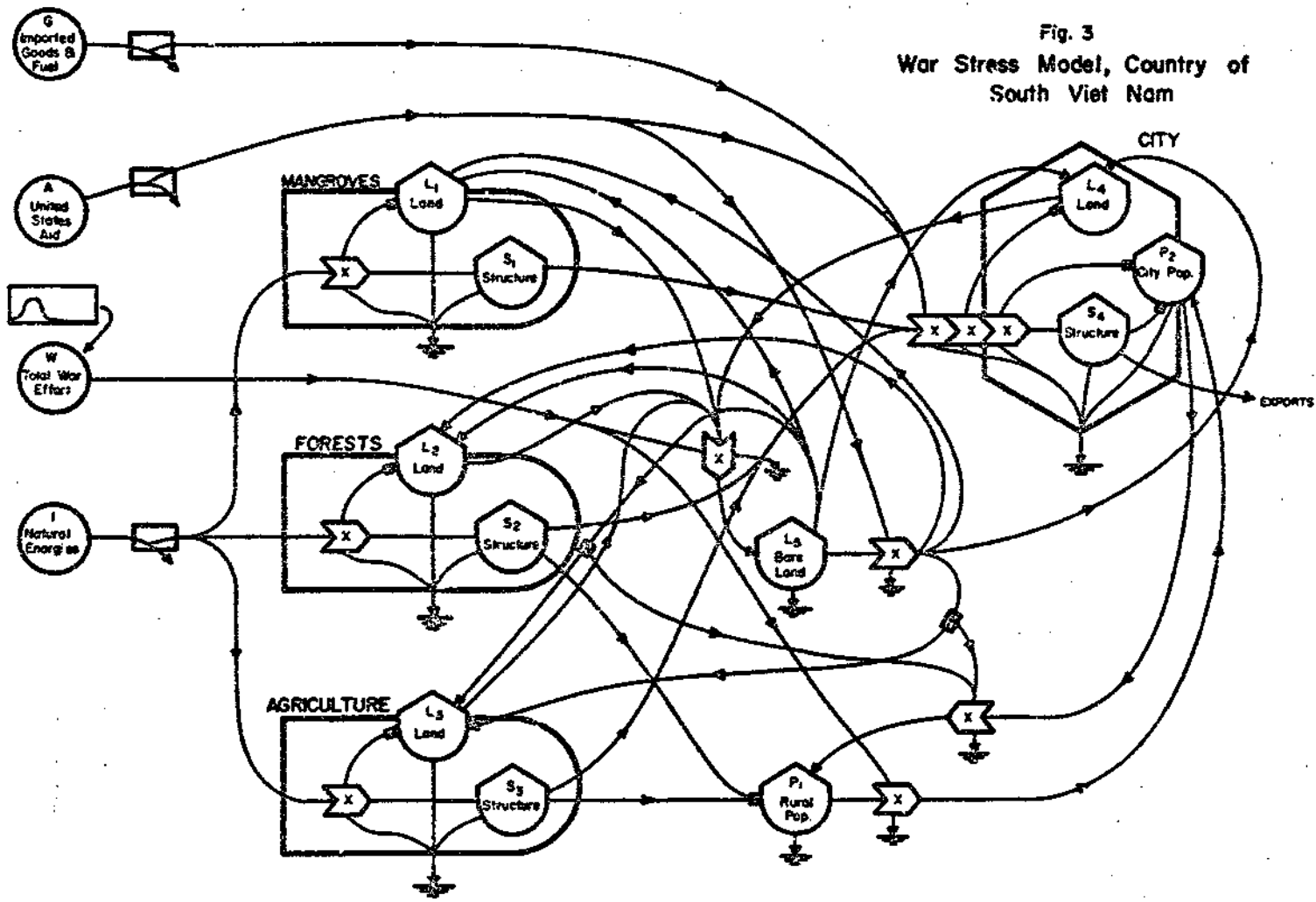

Fig. 3
War Stress Model, Country of
South Viet Nam

(A) have functions generated to more accurately depict the escalation of U.S. involvement in Indo-China. The War Effort (W) starts (1950) with minimal war; the approximate level of conflict prior to U.S. involvement. In 1965 the level increases reaching a maximum in 1967, then decreases to an estimated level of conflict equal to that prior to 1965. (See Appendix C.)

United States Aid (A) remains at zero (0) until 1960, then increases at a rate constant with reported U.S. Aid. In the first simulation (Fig. 4a-f) Aid was held constant (after 1970), at the 1970 level. In the second simulation (Fig. 5a-f) Aid was increased after 1970 to a maximum in 1985, then terminated. And in the third simulation (Fig. 6a-f) Aid was decreased steadily after 1970 and terminated in 1980.

Figures 4a-f, 5a-f, and 6a-f are computer generated graphs of the first, second and third simulations of the model. The graphs indicate a steady state system from 1950-1965 (with slight decreases in certain storages [L_2 , S_2 , L_3 , S_3]) until escalation of the war in 1965, causing decreases in all compartments of the system except the human settlements.

The Mangrove systems (Fig. 4B) show the expected disruption anticipated by the calculations in Table 1. However, the structure component (S_1) continues to decrease after the pulse disordering of war, probably due to increased wood cutting for charcoal. There is no recovery as might be expected because provisions for a seeding program are not included in the model. In the second and third simulations little change is exhibited. The structure does decrease however, with the second simulation due to increased demands of the human settlements.

The forest systems (Fig. 4c) of the country exhibit a slight decrease in the first simulation, somewhat aggravated by the increased demands of the growing human settlements. Recovery, as expected, does occur, but the system does not

Figure 4
CONSTANT AID

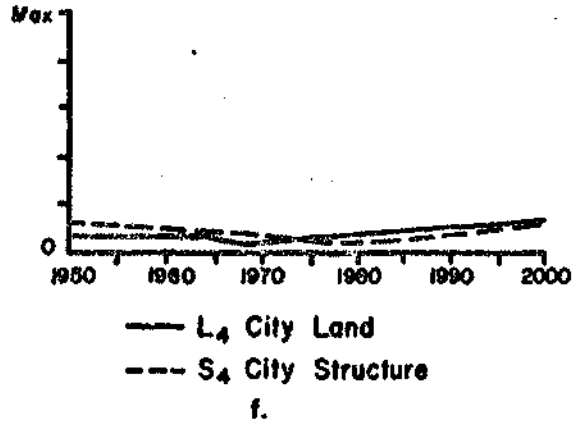
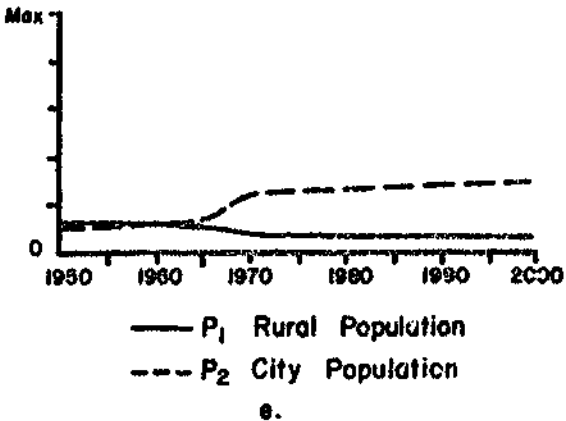
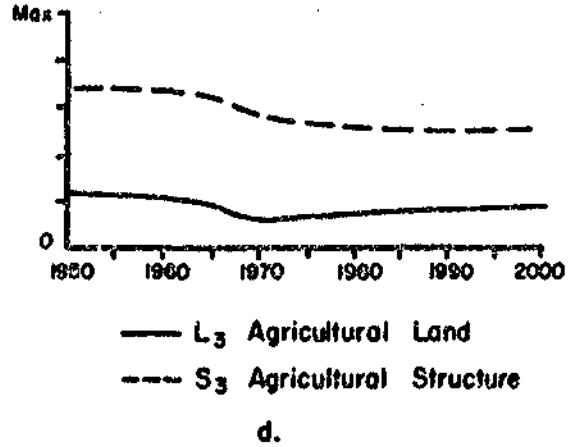
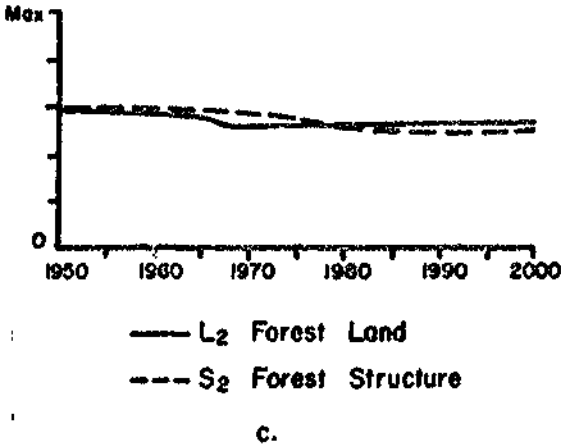
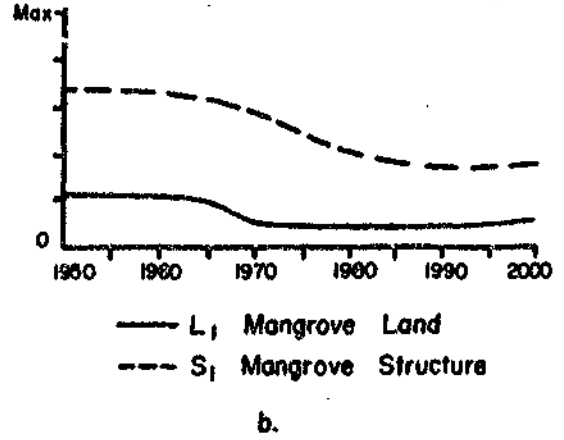
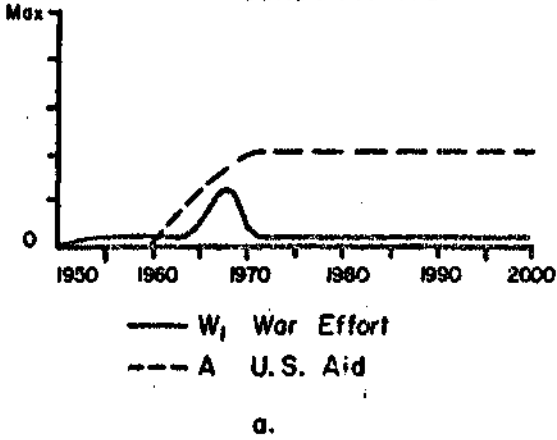
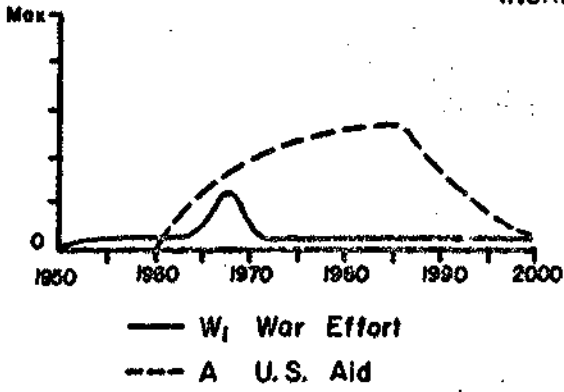
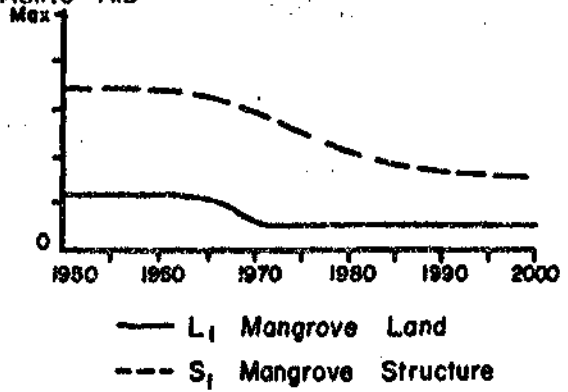

Figure 5
INCREASING AID



a.



b.

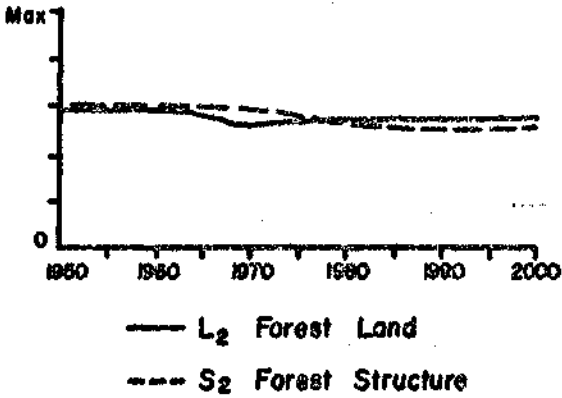

c.

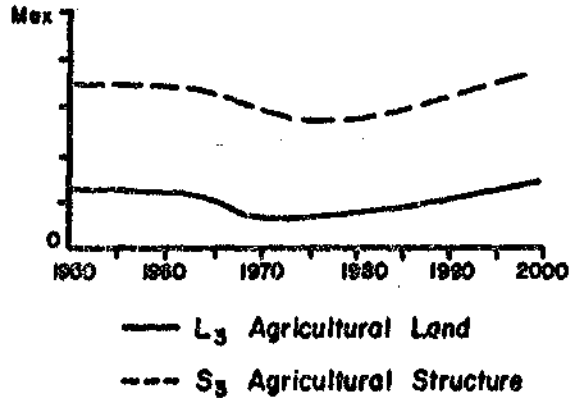

d.

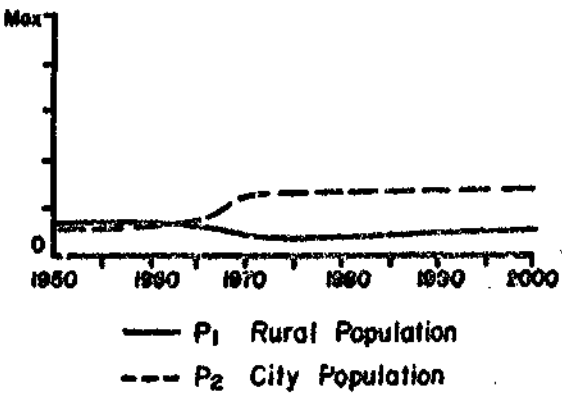

e.

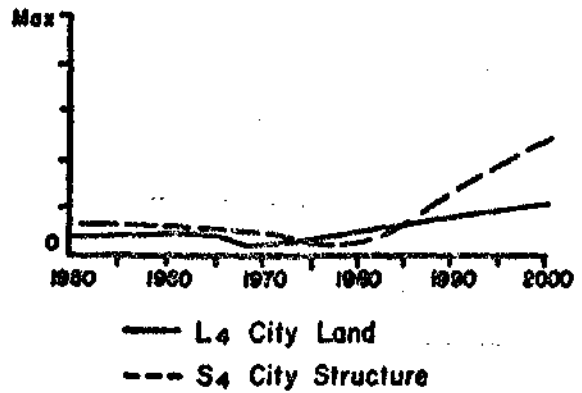

f.

Figure 6
DECREASING AID

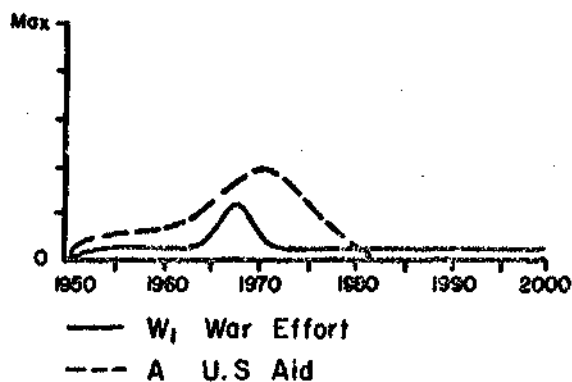

a.

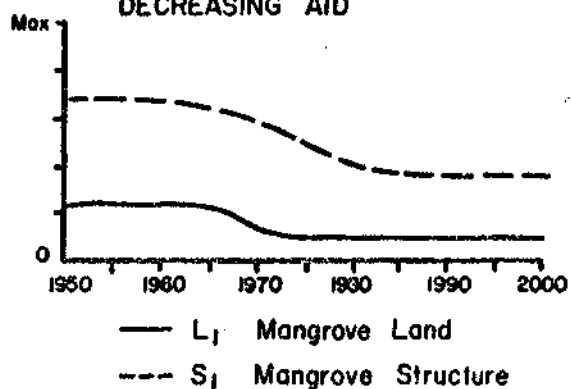

b.

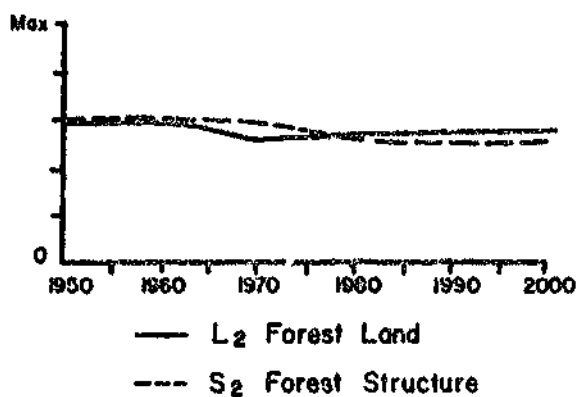

c.

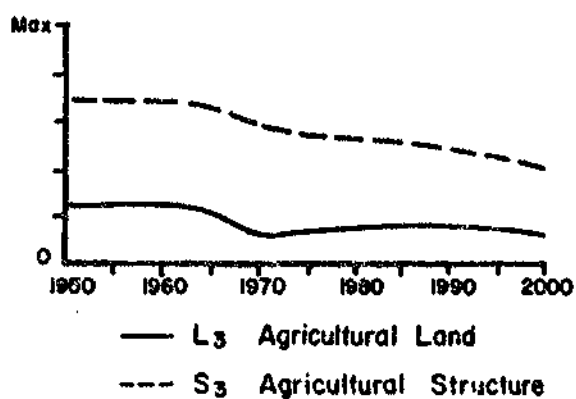

d.

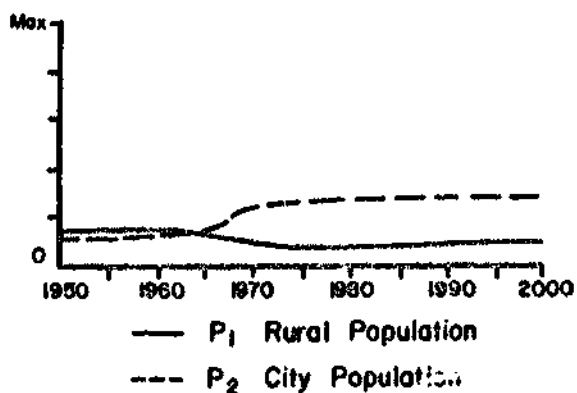

e.

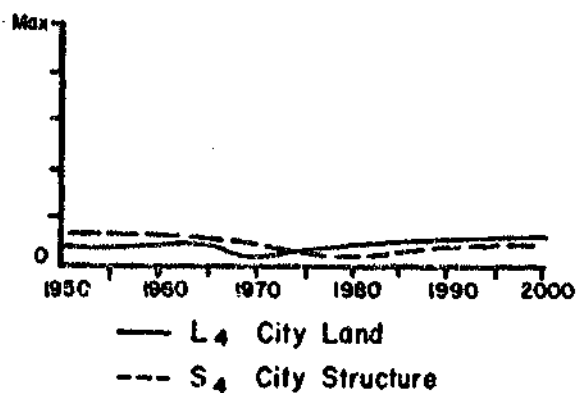

f.

U.S. Aid Ordering (US \$ millions)

1965	202.3	265
1966	478.9	406
1967	271.6	356
1968	295.5	370
1969	206.7	477
1970	369.4	504

— Official Aid

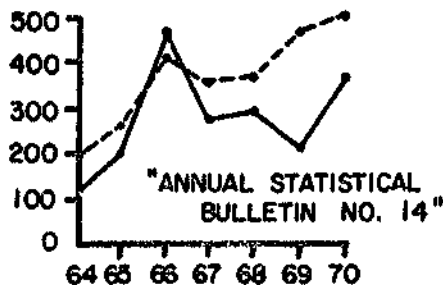

U.S. War Appropriations (US \$ millions)

1965	100
1966	6,000
1967	18,000
1968	23,000
1969	22,000
1970	17,000

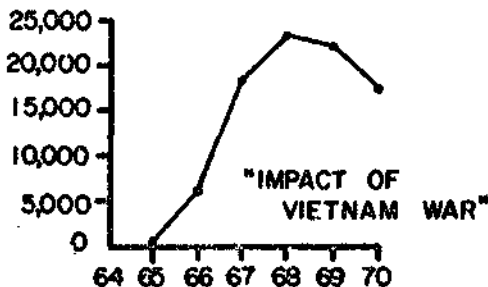

Fuel to War Effort (millions of barrels) (partial figures)

1965	73,881
1966	112,995
1967	146,697
1968	173,766*

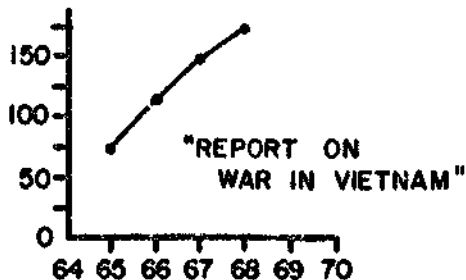

Military Goods (thousands of tons) (partial figures)

1965	3,300*
1966	7,280
1967	11,800*
1968	14,840

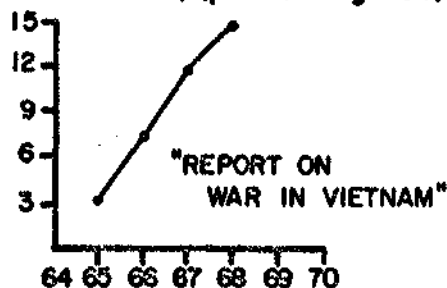

* Only six month figures were given for these years, so figure was doubled for year total.

Notes to Figures 4, 5, 6

Maximum values for each component are as follows:

- W_1 , War Effort - 2.5 billion \$
- A_1 , U.S. Aid - 1 billion \$
- L_1 , Mangrove land - 3.3×10^7 acres
- S_1 , Mangrove structure - 2.1×10^{10} kg
- L_2 , Forest land - 3.3×10^7 acres
- S_2 , Forest structure - 16.1×10^{18} kg
- L_3 , Agriculture land - 3.27×10^7 acres
- S_3 , Agriculture Structure - 1.1×10^{10} kg
- L_4 , Urban Land - 3.3×10^7 acres
- S_4 , Urban structure - 6.8×10^{11} kg
- P_1 Rural Population - 11.0×10^7
- P_2 Urban Population - 18.3×10^6

reach the level of productivity exhibited at the beginning of the simulation run. Flows of Aid have little effect on the system, and even when tripled no perceivable difference was noted. The transfer coefficient for the flow returning to forest land from bare land as a result of U.S. Aid (K.) is extremely small accounting for the lack of effect.

The agricultural systems (Fig. 4d) show the greatest change due to the disruption by war, decreases in the rural population, and increased urban demand. In the first simulation production of the system after disruption does not recover to the initial level. Increased aid in the second simulation provides the energy necessary to increase agricultural production to a level slightly higher than the initial, by transferring more land back into production and increasing the movement of refugees back to the rural areas. In the third simulation, by cutting off aid, production remains lower than the level obtained in Simulation 1, as might be expected.

Consequences of the population shifts (Fig. 4e) are felt throughout the system and are very important flows regarding the overall stability of the country. In the first simulation the movement of the rural population to the cities puts additional burdens on the entire system. Manipulation of this flow caused extreme changes in most compartments. If the rate of movement to the human settlements was decreased all components exhibited faster recovery rates, and the loss of agriculture production was not as great. If the rate of movement was increased the opposite occurred. This "system sensitivity" to the movement of the populations begins to indicate the extent to which the country's stability is aggravated by the secondary effects of the refugee problem. In the second simulation, movement back to the rural areas is facilitated by an increased flow of agricultural land back into production. In the third simulation, diminishing aid has little effect on the return of the rural population.

The human settlements (Fig. 4f), while showing smaller visible changes, are

interesting in view of the time delay involved in the build up of city structure (S_4) following the increased urban expansion (L_4). By the year 1970, increases are apparent in city land. However, due to shortages of materials and energies, and pressure from an increased population, a time lag of ten (10) years is required before the materials and energies are available for growth of city structure. Recovery to the initial level does occur by the year 2000. This does not meet the demands of the larger population. Increasing aid in simulation 2 meets these demands easily. The increase in city structure in this case begins to show a run-way growth, possibly an undesirable consequence. In the third simulation decreased aid prolongs the time delay and reduces the final structure value.

Overall Perspective

Consequences of the war in Vietnam are difficult to evaluate directly. The immediate effects of the disordering energies have caused a 3.1% disruption of the 6 year cumulative energy budget (1965-1970) of the country. The herbicide program accounts for nearly half this disruption: an interesting consequence, indicating the high amplifier value of the relatively low energetic cost of herbicides.

Simulation of the War Stress Model reveals additional stresses and indicates that depending on the new energies added, by the year 2000, the country of South Vietnam may still be showing the consequences of a 6 year war in the 1960's. It is important to note here that the recovery of the system depends on continued (and possibly increased) flows of United States Aid (a situation which may be unrealistic in light of increased energy shortages being felt throughout the U.S.)

Delays in ending the present level of conflict may cause delays and reductions in the recovery rate of order in the country. As long as needed, materials and energies are diverted from the job of reconstruction to that of fighting brush wars with the Viet Cong and North Vietnamese, regrowth of the country may be delayed. Stability in any system is related to the diversity of normal occupations and com-

ponents; and as suggested earlier, continued conflict may result in maintaining a low diversity and thus a low successional state. On the other hand, the system may be developing special adaptations to War Stress Energies so that they are not so destructive to the overall processes.

Other models simulated for the country of South Vietnam at war suggest a regrowth and in some instances increased productivity; and parallels have been drawn between South Vietnam and the countries of Germany and Japan after the second World War. However, the reordering and recovery of Germany and Japan were accomplished with great expenditure of outside "ordering energy" during a time of increasing fossil fuel availability and utilization. The same rapid reordering of South Vietnam may be unrealistic in view of increased demand and decreased availability of fossil fuel energies. The War Stress Model indicates that without increased aid the reordering may take many years more than intuitively apparent.

APPENDIX A

General Notes on Figure 1

The conversion from \$ (American) to kcal was calculated as roughly 14,000 kcal/dollar. (This figure was calculated in the same manner as Odum, 1971.) The total fossil fuel budget and hydro electric production was divided by the GNP of the country. The most complete figures were for the year 1966. The figures for fossil fuels were as follows:

<u>Fossil Fuel Type</u>	<u>Metric Tons Imported</u>	<u>kcal/g</u>	<u>kcal x 10¹⁰</u>
Petroleum	25,647	12	30.72
Aviation gas	166	11	.18
Gasoline	203,920	12	244.68
Kerosene	236,337	10	256.34
Gas oil	67,810	10	67.81
Fuel oil	562,595	10	562.60
Natural gas	6,080	12.5	7.60
Petroleum coke	820	7	.51

TOTAL 1170.50 X 10¹⁰ kcal/year

The figures of metric tons imported are from "Vietnam Statistical Yearbook 1970". Hydro electric production was calculated from a map showing location, type and capacity of hydro electric generating plants found in "Vietnam Subject Index Maps" minimum value for each plant was used (see table below). The total kcal/yr energy budget was 2750.0 X 10¹⁰. This was divided by the GNP of the country for the year 1966, 2.0 X 10⁹ dollars, ("Impact of the Vietnam War"). The figure obtained was 13,660.6 kcal/dollar.

3 power plants @ 10,000 - 50,000 kw.	3 @ 30,000 = 90,000 kw
2 power plants @ 50,000 - above kw	2 @ 60,000 = $\frac{120,000 \text{ kw}}{210,000 \text{ kw}}$
210,000 kw = 1.84×10^{10} kwh/yr (8.60×10^2 kcal/kwh) = 15.80×10^{12} kcal/yr	
TOTAL 2750×10^{10} kcal/year	

Q₁ Land area in the cities - 2.47×10^4 acres is based on 100 Km^2 as stated by Meselson et al. (1970). This figure is for 1970, however, it includes only major urban areas, so it is felt that it is a good reflection of all urban areas including villages + hamlets in 1965 - these small urban systems are not classically held as urban areas but generally as rural; however, because of the "undeveloped" status of the country and the role of the village + hamlet as major elements in the hierarchy of the governmental structure; they are included in urban areas. This figure represents .058% of the land area of the country.

Q₂ Goods in Country - This storage represents the combination of imports and goods produced within the country minus exports. Imports and exports were easy figures to obtain from a number of publications including "annual statistical bulletin" and "Vietnam Statistical Yearbook, 1970" and industrial production were obtained from "Annual Statistical Bulletin No. 11". This data does not include enterprises whose 1962 output was less than 2,000,000 \$VN in value. Thus, much of Vietnam's industrial production is excluded e.g. salt mining, quarrying, furniture making, printing, and handicraft production. For 1965, the goods within the country was calculated as 4.17×10^6 metric tons.

Q₃ Capital in the City - Capital in the city is used here to mean the money supply that is available throughout any year. This figure was computed from a table "Money Supply" in billions of piasters from the Annual Statistical

Bulletin No. 11 by dividing by the exchange rate of 118 piasters to the American dollar. Two figures are given, the year end value and the amount available at the beginning of the year. For 1965 the year end value was \$393.2 million and the amount available at the beginning of the year was \$232.2 million.

- Q₄ Land area in agriculture - The land area in agriculture is all land in Vietnam under cultivation Vietnam Statistical Yearbook 1970. Table 14-- Agricultural crops: planted area and production, 1960-1969. The planted area for each major crop was totaled and the agricultural land area that had been defoliated was added to this figure as was the land area bombed. The total land area during 1965 that was in agriculture production was 7.308×10^6 acres.
- Q₅ Agriculture Structure - As used here agriculture structure means the yield in kgm of the land area in agriculture. The year end total yield was obtained from Vietnam Statistical Yearbook 1970 as was the land area. The total yield and planted areas were 705.8×10^7 kgm and 7.238×10^6 acres respectively. By dividing yield by planted area the yield per acre was obtained (975.1 kgm/acre)*. This then was multiplied by the planted area (total before herbicides, spray, and bombing) to obtain maximum yield value of 7126.0×10^6 kgm.

- Q₆ Land Area in Military Bases - This value has been requested from the Department of the Defense but to date has not been received. For lack of any better figure this value was estimated by assuming that for each member of

* This yield/acre is approximately 1/6 that calculated for Florida which has a yield 5,985 kgm/acre for all crops, however, Vietnam's growing season is shorter due to monsoon weather, and they do not have a fossil fuel subsidized agricultural system to the extent of that of the U.S.

the combined U.S. and S.V.N. armed forces a minimum of 1.5 acres* are required to provide housing, necessary services, and storage for them and their support equipment.

Q7 Land area in Forests - Meselson et al. (1970) estimate forest area to be 100,000 km². Included under the designation "forest" are all lands with trees whose crowns cover more than twenty percent of the area. This estimate is based on low resolution aerial photography and on U.S. Army terrain difficulty maps. The forestry services for the French colonial government estimated the total area of economically valuable hard wood forests at 50,000 km² leaving out forests that were badly degraded, very young, or located on partially inaccessible mountain terrain. A value of 75,000 km² was estimated from a vegetation map published by the government of Vietnam. This value was chosen as a rough approximation of the forest area at the beginning of 1965, because the greatest expenditure of herbicides in Vietnam has been on fairly mature tropical hardwood forest (Meselson, et al., 1970). In acres the total forest area for 1965 is 18.5×10^6 .

Q8 Upland Forest Structure - Rodin (1967) stated standing crop for subtropical hard wood forest to be 4.1×10^4 g/m² and that for rain forest 5.0×10^4 . Since a large majority of the forests of Vietnam are of the moist forest type and the next most frequent type is secondary forests, a biomass of

*It is assumed that a military base has the same basic system functions and flows as the urban system (with some specialized functions in terms of equipment storage, and control mechanisms.) All calculations using urban systems in Southwest Florida indicate for each urban inhabitant .85 acres are required to house and provide them with necessary services. Due to the higher energy flows of the military system as compared to the urban system and an accompanying increase in structure, it can be assumed that larger amounts of land will be necessary to accommodate the system components. Thus, an increase of 75% in land area over than required to house and maintain services for military personnel was estimated.

$3.5 \times 10^4 \text{ g/m}^2$ was used.

The tropical moist forest covers approximately 70-75% of the forest area while the secondary forest make up the remaining 25-30% with small areas of semi-deciduous and dipterocarp dry forests. (Estimates from General Forest Map, Government of South Vietnam.)

The total biomass or standing crop for 1965 was calculated by multiplying the biomass per sq. meter by the area of forests ($18.5 \times 10^6 \times 4047 = 2.62 \times 10^{11} \text{ m}^2$) ($3.5 \times 10^4 \text{ g/m}^2 \times 2.62 \times 10^{11} \text{ m}^2$) = 9.17×10^{18} kg of biomass.

Q₉ Dead wood (Dead forest structure) - Prior to 1965, 438 km² of forest land had been sprayed (Herbicide Assessment Commission of the American Association for the Advancement of Science, Background material relevant to presentations at the 1970 annual meeting of the AAAS, Chicago, Ill. (Dec. 29, 1970) p. 14.) "Some estimates indicate that one out of every eight trees is killed by a single spraying and that 50 to 80 percent are killed in areas where more than one spraying has occurred." (same reference). Therefore, a low estimate of 20% killed in those areas sprayed has been made. This estimate takes into account the 10% to 12.5% killed after the first spray and allows for an additional 10% due to scattered second sprayings. The amount of dead wood for 1965 was calculated to be 3.06×10^9 kg, and was figured in the following manner: $(438 \text{ km}^2)(10^6 \text{ m}^2/\text{km}^2)(3.5 \times 10^4 \text{ g/m}^2)(10^{-3} \text{ kg/g})(.20) = 3.06 \times 10^9 \text{ kg}$.

Q₁₀ Bare Land - is those areas that have had the standing crop markedly reduced; it does not necessarily mean top soil that is exposed, although in some cases it is, but merely those areas throughout SVN that have had the standing crop removed and are in various stages of succession. In the three years prior to 1965 458 km² of forests and 46 km² of agricultural lands had been sprayed (impact of Viet Nam War, 1971). Of the forests sprayed 20 km² of the 458 km²

was mangrove.* Calculating the amount of bare land that had accumulated by 1965 was done by assuming first: that 90% of the mangrove land sprayed was still bare based on statements by Tschirley (1969) that mangroves are particularly susceptible to defoliants and that one application at the normal rate employed in Vietnam is sufficient to kill most of the trees. And possibly because of lost seed source there has been little or no reestablishment of the forest; second, that 17% of the upland forests sprayed prior to 1965 are still bare land calculated in the following manner: it was assumed that of the area sprayed a 20% kill was achieved with one application of defoliants in the upland forests. Of this 20% at the end of one year 2.8% has recovered or bare land is now 19.44%. At the end of 2 years 8.8% has recovered or 18.24% bare land; at the end of 3 years 13.4% of the 20% has recovered or 17.32% is still bare land. Third, that agriculture land sprayed is 90% defoliated for that year, assuming that some land might be replanted within the year and be replanted the following year with a 50% overlap. In other words 50% of that land sprayed in 1964 is still bare at the end of 1965 and 1/2 of that land will be replanted. The remaining 1/2 will not be replanted due to the abandonment of villages and hamlets because of the resettlement of the people who were in conflict areas. Fourth, that forest and agricultural structure destroyed by bombing is calculated in the same manner. However, there is no data available for the years prior to 1965. Thus, it was assumed there was none.

*This area was measured of official DOD spray run maps at a scale of 1:1,000,000. At this scale it is difficult to determine exact areas, however, these maps are computer drawn and give an accurate indication of where the spraying occurred. 3 different widths of individual spray were observed from these maps; these were assumed to be 25, 150, and 225 meters wide.

The value of bare land is as follows:

forest sprayed in 1962	20 km ²	(13.4%)	2.7 km ²
1963	100 km ²	(18.24%)	18.2 km ²
1964	346 km ²	(19.44%)	61.6 km ²
Mangrove sprayed prior to 1965	20 km ²	(90%)	18.0 km ²
Agriculture sprayed in 1964	42 km ²	(50%)	21 km ²
Forest sprayed in 1965	615 km ²	(20%)	123 km ²
Mangrove sprayed in 1965	17 km ²	(90%)	15.3 km ²
Agriculture sprayed in 1965	267 km ²	(90%)	240.3 km ²
TOTAL			500.1 km ²

- Q₁₁ Seeded land in mangroves - The total area of mangroves in South Vietnam has been estimated as 2,800 km² (.691 X 10⁶ acres) (Meselson *et al.*, 1970) and Tschirley, 1969). 20 km² had been sprayed prior to 1965 giving an area of 2,780 km² (.687 X 10⁶ acres.)
- Q₁₂ Mangrove forest structure - This structure index includes only woody stem biomass and has been estimated as 5,000 g/m² (Golley *et al.*, 1962) and between 4,000 g/m² and 6,000 g/m² by Banijubutana (1957). The value of 5,000 g/m² was used, thus, for 1965 (2,800 km²)(10⁶ m²/km²)(5000 g/m²) = 14,000 X 10⁶ kg.
- Q₁₃ Dead wood (mangrove) - There was 20 km² (20 X 10⁶ m) sprayed prior to 1965 and a 90% kill has been estimated, thus, (20.0 X 10⁶ m²)(.90)(5000 g/m²) = 90.0 X 10⁶ kg as stated by Tschirley (1969). There seems to be very little apparent recovery or reestablishment after one spraying. However, if there is, the 90% kill is a conservative estimate and would account for any reestablishment.
- Q₁₄ Wood cutters - The number of people engaged in wood cutting is impossible to count. Every refugee is a potential wood cutter because it provides a readily

available income source.

Q₁₅ Viet Cong, N. Vietnamese troops in country - Very difficult to obtain, finally found a reference in "Aviation Week and Space Technology", Jan. 3, 1966.

"Present Viet Cong strength: (1966)

80-90,000 regular troops

100,000 guerillas

40,000 political activists"

This is an increase of 85,000 over May 1965 estimates of 38,000 - 46,000 regulars and 100,000 irregulars by Pentagon." Thus, a figure of 140,000 men was used for 1965; 40,000 regulars and 100,000 irregulars.

Q₁₆ Land area in bomb craters - Very difficult figure to obtain; there are no estimates or data available as yet on the size of craters produced per pound of TNT or for different size bombs, much less how many of different size bombs have been dropped. "...there are two variables that make estimates almost impossible, type of fusing and type of terrain (soil) that bomb is dropped on. (There are) Many types of fusing devices and each will produce different results, and if fused to explode on contact with soil, and explodes on contact with trees instead, a different result is obtained." (Personal interview commander, Univ. of Fla. AFOTC). We therefore have relied on two sources for estimates on the size of craters. Aviation Week and Space Technology, Nov. 29, 1965, p. 18 - "When delayed fusing is used craters on the ground are 25-30 feet deep and 50 feet wide at the top with a blow down of 150 feet in diameter in heavy undergrowth in Iron Triangle area with soft, loamy soil. Westing (1972) states from personal observation that the craters were "20 to 40 feet across and 5 to 20 feet deep." He uses an average diameter of 30 feet and depth of 15 feet. We have therefore relied on the following figures: craters 30 feet in diameter and 20 feet deep with a blow down of 100 feet in diameter.

To estimate the number of craters, it was assumed that 75% of all air munitions, expended were 500 pound bombs capable of producing a crater as described above.

The air munitions expended in 1965 was 315,000 tons (see "Impact of the Vietnam War), 75% of this figure is 236,250 tons (2,000 lbs/ton) = 945,000 bombs capable of producing a 706.5 sq. feet crater and a bare land area of 7,100 sq. ft., thus the area of craters (706.5 sq. ft.)(9.45 X 10⁵) = 667,442,500 sq. ft. of craters (2.3 X 10⁻⁵ acres/sq. ft.) = 15,358 acres of craters.

Q17 People - The "Annual Statistical Bulletin" gives the total population for South Vietnam in 1965 as 15,921,000. However, it states "...all population figures for Vietnam should be regarded as estimates or gross approximations. The reliability of data for cities is significantly better than for rural areas. Internal security requirements prescribe that each head of household must register himself and all those residing with him at a local police station and keep this registration up to date. It is these records which local authorities draw upon when reporting population data to the National Institute of Statistics. It is believed that the 1960 figures represent a fairly accurate estimate of population. With the deterioration of security, registration data became incomplete and the NIS has deemed it advisable, beginning in 1961-1967 figures represent extrapolations of 2.5% per year on the 1960 figures.

Flow 1. Incoming Energies to city.

A value of \$252.8 million (US) was estimated for 1965 by consulting Table 9 in "Annual Statistical Bulletin No. 14" import arrivals by Major Commodity. Those commodities that were clearly consumer goods were added along with petroleum products, those chemicals not used in agriculture, textile industry goods, machinery and vehicles that were clearly not agriculture oriented, pulp and paper products and 66% of the commodity labeled "other" (the remaining 34% was divided between agriculture and urban development energies.) Those commodities that were clearly for the city were assigned to either agriculture or urban development or both; by assuming 4% to agriculture and 30% to urban development. Based on finding a percentage that the known quantities of each was of the total, and the heading others was divided in the following this dollar value, \$257.8 million U.S., was then multiplied by the current conversion factor of 14,000 kcal/\$ (see general notes) to obtain 3.54×10^{12} kcal/yr. This is the energetic value of imports to the city for 1965.

Flow 2. Energies to Agriculture.

See Flow 1 for explanation. This value, \$18.0 million U.S. for 1965 was multiplied by current conversion factor of 14,000 kcal/dollar giving 2.52×10^{11} kcal/yr.

Flow 3. Energies for Urban Development.

See explanation for Flow 1 for calculation of value. \$117-8 million U.S. (14,000 kcal/dollar) = 1.65×10^{12} kcal/yr for 1965.

Flow 4. Bombs Expended.

As described in the explanation for Q16 land area in bombs craters, to estimate the number of bombs it was assumed that 75% of all air munitions expended were 500 pound bombs.

The air munitions expended in 1965 was 315,000 tons (input of Vietnam War)

(.75) = 236,000 tons. In reality this percentage represents only 37.5% of the total munitions (land, sea, air) expended, therefore, a very conservative estimate.

Flow 5. Energy of Rome plows to scrape land.

In 1965 this value is 0 (zero). Rome plowing was started in Vietnam in 1968.

Flow 6. Herbicides sprayed on agricultural land.

This figure was calculated by multiplying the area sprayed by the spraying rate of 3 gallons per acre*. For 1965 the cropland sprayed was 65,949 acres*. This multiplied by 3 gal per acre gives: 197,847 gallons of herbicides.

Flow 7. Herbicides sprayed on upland forests.

Calculated by multiplying the area of forest sprayed (found in "Impact of the Vietnam War") as total forest areas sprayed. This figure represents all forests including mangrove; thus, mangrove sprayed were subtracted from total forest areas by the application rate of 3 gal/acre. For 1965, 151,831 acres of forest had been sprayed which would require 455,493 gallons of herbicide.

Flow 8. Herbicides sprayed on mangroves.

Calculated by multiplying the land area of mangroves that were sprayed by the application rate of 3 gal/acre. Thus, for 1965, 3,770 acres were sprayed using 11,337 gallons of herbicide.

Flow 9. V. C. and N. Vietnamese in active military engagements.

Assuming that there were 140,000 V.C. and NVN troops in South Vietnam in 1965** and that these were broken into the following percentage groups as follows

*Herbicide assessment commission for the AAAS. Background material relevant to Presentations at the 1970 annual meeting of the AAAS, Chicago, Ill., Dec. 29, 1970. p. 14.

**Aviation Week and Space Technology, January 3, 1966.

44% guerillas, 33.3% political activists, and 17.7% regular troops.* And assuming that regular troops and guerillas are both active in military engagements then 67.7% of the 140,000 troops or 96,380 troops are in active military engagements.

Flow 10. City Land Bombed.

A difficult estimate to make - this figure was derived by assuming that all bombing done was evenly distributed throughout the country and then calculating the % of the total land area of the country that is in city land. This was found to be .058% and multiplying this times cratered area of 15,358 acres gives 890.7 acres of city land bombed. The reason for using cratered land instead of the cleared land as in agriculture and forest land bombed (see Flows 12,13) is simply because of the structural differences. City structure is exceedingly more difficult to move so it was assumed that only the actual cratered area was cleared. Again this estimate is exceptionally conservative on two counts. First, it seems entirely possible that more than .058% of all bombs dropped on South Vietnam were in cities and, second, assuming that the only area of destruction for each bomb was that of the cratered area is very naive at best; this figure could range as high as 10 times this amount. However, working with only published information and not having access to certain classified information it is felt that conservative estimate is better than one that might be subject of much debate.

Flow 11. People killed.

"The Senate Refugee Subcommittee estimated that there have been 1,050,000 civilian casualties in Vietnam between early 1965 and early 1971, including about 325,000 killed." (Impact of the Vietnam War). An estimate of 50,000

*Based on reported estimates of 100,000 guerillas, 80-90,000 regular troops, and 40,000 political activists for the year 1966 by Pentagon.

was assumed by equating war deaths to the relative scale of war year by year, 1965-1970.

Flow 12. Agriculture Land Bombed.

Again assuming that bombing was evenly distributed throughout the country, and calculating the % of the land area that is agricultural land (17.23%) and multiplying this times the total cleared area of 169,000 acres* gives 31,100 acres of agriculture bombed and cleared. This area will be returned to agricultural production within the year, however, so it was felt a more accurate assessment of damage to agriculture land would be in the amount of land that was left in craters and therefore unusable for agriculture. This was found by multiplying the total cratered area, 15,358** acres by 17.23% given an area of 2,672 acres in craters.

Flow 13. Upland Forest Land Bombed.

Again assuming that bombing was evenly distributed throughout the country and calculating the % of land area that is upland forest (58.8%) and multiplying this times the total cleared area (blowdown) caused by bombs, 169,000 acres (.179 acres#/bomb X 555,700 bombs gives 99,732 acres bombed and in bare land for the year. The amount of land in craters was found by multiplying 58.8% times the area of total craters 15,358 acres*** giving 9,030 acres in craters.

Flow 14. Craters in Natural Succession.

This is a very difficult number to judge - the actual crater in most cases does not disappear from the landscape but to some extent will remain a permanent

*Based as a flow down of 100 ft. diameter (Aviation Week and Space Tech, 11/29/65)

**Based a crater size of 3 ft. in diameter (Westing, 1972) and (Aviation Wk. and Space Tech, Nov. 29, 1965.)

‡Based on a blowdown of 100 ft. in diameter from (Aviation Wk. & Space Tech, Nov. 29, 1965.)

‡‡Based on a crater size of 30 ft. in diameter, (Westing 1972) (Aviation Wk & Space Technology, No. 29, 1965.)

feature (Orians 1970). However, there is noticeable filling from soil wash down, and in some cases aquatic systems (where the crater remains wet year around), are present after approximately one year (Pfeiffer, 1971). Where these craters are in agricultural areas they become practically unusable except for irrigation purposes; there also have been some reports that craters have been used for fish ponds in forest regions. The return to its former state is a slow process indeed, starting with some grasses (Imperata) and eventually supporting some woody brush, vines and bamboo. It is therefore assumed that the successional rate of craters is approximately .01% for lack of any real data. This means that .001% per year of existing craters are retained to this natural productivity or $.001 \times 15,358$ acres of craters = 15.36 acres in 1965-66 were returned to their natural state, or some other productive state useful to man.

Flow 15. Agriculture Land Some Plowed.

This value is zero (0); some plowing was started in early 1968. However, in later years this was calculated in the following manner.

Flow 16. Forest Land Some Plowed.

Again this value for 1965 is Zero (0); started in 1968, however, in later years, this value was calculated in the following manner.

Flow 17. Forest Land Herbicided.

In 1965 155,610 acres of forest land were sprayed ("Impact of Viet Nam War"), this value includes mangrove land sprayed, thus, from official department of Defense Spray Flight overlays it was determined that 3,779 acres of mangrove was sprayed leaving a total of 151,831 acres of upland forest sprayed.

Flow 18. Agriculture Land Herbicided.

Agriculture land area by year that has been sprayed: 90% was assumed to be defoliated and unusable for the entire year for several reasons. First,

because farmers may have abandoned field; second, defoliation occurring late in the growing season, and third, to compensate for any error due to second applications in certain areas. Thus, for 1965 $-(6.60 \times 10^4 \text{ acres})(90\%) = 5.94 \times 10^4 \text{ acres}$.

Flow 19. Mangrove Land Herbicided.

This figure was measured off of official Department of Defense Spray Flight overlays, (see Qio-Bareland for explanation.) Area was 3,779 acres.

Flow 20. Bareland in Natural Succession.

Of the total bareland in storage in any one year, the flow back into forest land by natural succession is calculated in the following manner; of the forest land defoliated that year 0.0% returns to forest, of the forest land defoliated the year before (2 yrs previous) 2.8% returns to forest of that defoliated 3 yrs previous 8.8% returns to forest, of that defoliated 4 yrs previous 13.4% returns and that 5 yrs previous 17% returns, of that 6 yrs previous 72.8% returns; it was also assumed that 10% of agriculture land sprayed started into succession because of abandonment. The bare land in natural succession for 1965 was as follows.

1962 Forest Spray total 20 km^2 (20% killed) = $4 \text{ km}^2 \times 13.4\% = .54 \text{ km}^2$
 1963 Forest Spray total 100 km^2 (20% killed) = $20 \text{ km}^2 \times 8.8\% = 1.76 \text{ km}^2$
 1964 Forest Spray total 338 km^2 (20% killed) = $67.6 \text{ km}^2 \times 2.8\% = 1.89 \text{ km}^2$
 1965 Forest Spray total 630 km^2 (20% killed) = $126 \text{ km}^2 \times 0\% = 0$
 1965 Agriculture spray 267 km^2 (20% killed) = $240.3 \text{ km}^2 \times 10\% = 24.0 \text{ km}^2$

Flow 21. Bare Mangrove Land Returning to Seeded.

It was assumed that .05% of the total in any one year of bare mangrove land was returning to seeded. Thus, for 1965 there was 51.3 km^2 of mangrove land bare and in that year .05% of $.026 \text{ km}^2$ (6.34 acres) returned to seeded.

Flow 22. Bare Land Returning to Agriculture.

Here it is assumed that 85% of agricultural land killed remains fallow for one year only, then it is returned to planted land, and that 5% of bare forest land is reclaimed as agriculture.

10,374 acres sprayed in 1964 (85%) = 8,817.9

113,126 acres sprayed in 1965 (5%) = $\frac{5,656.3}{14,474.2}$

Flows 23, 25, 26, and 27. "Land" converted to Urban Land.

It has been estimated by A.I.D. that the urban populations of South Viet Nam have grown from 15 to 30 percent, and that the populations of Saigon and Danang together swelled by about 1 million persons in 5 years.* It is assumed that urban population has grown by 30 percent during the 6 year period (1965-70) at a constant rate of 5% per year. It is further assumed that urban structure growth during this time is proportional to population growth. Therefore, if the urban land area was 2.47×10^4 acres, then 5% growth per year will add 1,235 acres per year to South Vietnam urban areas.

Flow 28. Agriculture Structure Bombed.

As calculated for Flow 12, agriculture land bombed, 31,100 acres were cleared by bombing in 1965. The structure per acre was calculated as 975.1 kg/acre. Thus, the structure destroyed is calculated as the number of acres cleared multiplied by the structure per acre.

For 1965: (31,100 acres)(975.1 kg/acre) = 3.03×10^7 kg.

Flow 29. Forest Structure Bombed.

Calculated in the same manner as Flow 28, using 3.5×10^4 g/m² (see explanation for Q_g) as the structure, and 99,732 acres as the area cleared (see explanation for Flow 13).

For 1965 (3.5×10^4 g/m²)(99,732 acres)(4047 m²/acre) = 1.41×10^{10} kg.

Flow 30. Agriculture Structure Rome Plowed.

Plowed area multiplied by structure/acre (975.1 kg/acre). For 1965 -0- Rome plowing was started in 1968.

Flow 31. Forest Structure Rome Plowed.

Area cleared multiplied by structure/acre ($3.5 \times 10^4 \text{ g/m}^2$) ($4047 \text{ m}^2/\text{acre}$)
 $= 1.42 \times 10^5 \text{ kg/acre}$.

For 1965 -0- Rome plowing started in 1968.

Flow 32. Forest Structure Lost Due to Defoliation.

Area sprayed (151,831 acres) (see Flow 17) multiplied by 20% kill based on explanation for Q₉. Based on an initial standing crop of $3.5 \times 10^4 \text{ g/m}^2$, the structure lost can be calculated by multiplying the area killed by standing crop.

For 1965 - (151,831)(20%)(4047)($3.5 \times 10^1 \text{ kg/m}^2$) = $4.31 \times 10^9 \text{ kg}$.

Flow 33. Agriculture Structure Defoliated.

The area sprayed times 90% (see explanation for Q₁₀) multiplied by standing crops of 917 kg/acre.

For 1965 - 65,949 (.90)(9.71×10^2) = $5.95 \times 10^7 \text{ kg}$.

Flow 34. Mangrove Structura Defoliated.

Area of mangroves sprayed multiplied by 90% (representing the kill rate) and this multiplied by the figure for standing crop.

For 1965 (3779 acres)($4047 \text{ m}^2/\text{acre}$)(90%)($5.0 \times 10^1 \text{ kg/m}^2$) = $6.9 \times 10^8 \text{ kg}$.

Flow 35. Energies of woodcutters to cut wood.

This value is derived from the mean value for total energy expenditures of 5.908 kcal per minute given by Hartung and Raets (1968). Assuming that a wood-cutter's work day is 10 hours, his expenditure is then $5.908 \text{ kcal/min} \times 360 \text{ min.} = 2160 \text{ kcal/day}$.

Flow 36. Forest Structure Cut by Wood Cutters.

Data not available

Flow 37. Dead Forest Wood Cut by Wood Cutters.

Data not available

Flow 38. Mangrove Structure Cut by Wood Cutters.

Data not available

Flow 39. Dead Mangrove Wood cut by Wood Cutters.

Data not available

Flow 40. Goods bought by Wood Cutters.

Data not available

Flow 41. Goods Exported from South Vietnam.

From the "Vietnam Statistical Yearbook," p. 192. Weight of imports and exports by country - the total for 1965 was 1.77×10^5 metric tons. This value is derived from the sale of licenses, so it may of off as much as 10% either way.

Flow 42. Wood for Charcoal and Lumber to the City.

Data not available

Flow 43. Natural Energies to Natural Systems.

The sum of the natural potential energies of: Rivers (644×10^{12} kcal/yr), tides (152×10^{12} kcal/yr), rain as runoff (119×10^{12}), thermal heating (1680×10^{12} kcal/yr), wind absorption (52×10^{12} kcal/yr), and the chemical potential energy as gross photosynthesis ecological systems (1312×10^{12} kcal/yr). Total for 1965 is 3959×10^{12} kcal/yr.

Flow 44. Money to South Vietnam from Outside Sources.

Obtained from "Annual Statistical Bulletin No. 14," p. 11. Table III - Balance of Payments - 1962-1970 under official aid (sub-heading E). Total for 1965 \$264.8 million. This value includes official grants, U.S. Govt. holdings of disasters and official loans.

Flow 45. Money in exchange for outside energies.

Obtained from "Annual Statistical Bulletin No. 14," p. 9. Table I - Foreign Trade Summary 1958 - 1970, under GVN financed imports for 1965, \$85.4 million.

Flow 46. Money to Wood Cutters for Wood.

Data not available

Flow 47. Money from Woodcutters to City in Exchange for Goods.

Data not available

Flow 48. Money in Exchange for Exported Goods.

Obtained from "Annual Statistical Bulletin No. 14," p. 11. Table III

Balance of Payments - 1962-1970 under subheading A. Exports - 1965, \$40.5 million.

Flow 49. NVN Sources.

Data not available.

Flow 50. Abandoned and Agriculture Land.

This value was calculated by knowing the land area that was supposed to be in Agriculture for the following year and the amounts that flowed out during the present year. In each case the land areas that were lost due to herbicides, bombing and Rome plowing did not account for enough loss when compared to total land planted in the following year (Vietnam Statistical Yearbook). Thus, some land was lost to agriculture production due to movement of people off the land.

For 1965 - 5.73×10^5 acres.

APPENDIX B

Calculation of Disordered Lands by Year

1. Bombing.

In the 6 years from 1965 to 1970, 5,556,100 tons of air munitions and 128,500 tons of sea munitions were expended (Impact of the Viet Nam War, 1971). For the purposes of the model and lack of sufficient data it was assumed that 75% of the air munitions, only, were capable of producing craters equivalent to that of a 500 pound bomb (30' in diameter) with a blow down (cleared area) of 100' in diameter (Pfeiffer, 1971). This is probably an over estimate of the number of 500 pound bombs dropped. However, when compared with all crater producing munitions, the calculated cratered area is conservative at best. With these calculations, then, 16,668,000 five hundred pound bombs were dropped on South Viet Nam in these 6 years. This compares to 21 million estimated by Westing and Pfeiffer (1972).

It was assumed that the bombing was spread evenly throughout the country; knowing the relative % of the total area of the country in each of the four major land use categories (city land .058%; agricultural land 17.23%; forest land 58.8%; mangrove land 1.6%), the percentages of bombs dropped in each of these can be calculated. The number of crater producing bombs dropped in each land use category was then multiplied by the cleared area produced by one bomb (.181 acres). The following table shows year by year totals for bombs dropped and cleared area.

YEAR	TOTAL BOMBS	CITY LAND (Cleared Acres) x10 ²	AGRICULTURE LAND (Cleared Acres) x10 ⁴	FOREST LAND (Cleared Acres) x10 ⁴	MANGROVE LAND (Acres) x10 ⁴
1965	.96 X 10 ⁶	1.2 X 10 ²	2.9	10.0	.28
1966	1.5 X 10 ⁶	2.4 X 10 ²	4.8	16.5	.45
1967	2.8 X 10 ⁶	3.2 X 10 ²	8.8	30.0	.83
1968	4.3 X 10 ⁶	4.7 X 10 ²	13.4	46.0	1.26
1969	4.2 X 10 ⁶	4.5 X 10 ²	13.0	44.0	1.22
1970	2.9 X 10 ⁶	3.3 X 10 ²	9.1	31.0	.86

2. Herbicides.

In the six years from 1965 through 1970 a total of 5,092,228 acres of forest and 1,035,882 acres of cropland have been sprayed. Of the 5.1 million acres of forest sprayed 486,140 acres were mangroves*. The acres of defoliated land for each land use category were calculated in the following manner:

First, Agriculture land sprayed was assumed to be 90% defoliated for that year (assuming that some land might be replanted in that year) and the following year the land was replanted. Thus, only one year's yield is lost. Second, forest land area sprayed was assumed to be 20% defoliated based on statements from Meeselson et al. (1970) that "some estimates indicate that one out of every eight or ten trees is killed by a single spraying and that 50 to 80 percent are killed in areas where more than one spraying has occurred. Therefore, a conservative estimate of 20% killed was assumed. Third, 90% of Mangrove land sprayed was defoliated based on statements by Tschirley

*This area was measured on official Dept. of Defense herbicides spray-run maps, scale of 1:1,000,000; year by year totals for Mangrove land sprayed are as follows: 1965 - 4700 acres; 1966 - 96,330 acres; 1967 - 197,600 acres, 1968 - 68,666 acres; 1969 - 90,155 acres; 1970 - 11,609 acres.

(1969) that Mangroves are particularly susceptible to defoliants and that one application at the normal rate employed in Viet Nam is sufficient to kill most of the trees, and possibly because of loss of seed source there has been little or no reestablishment of the forest. The following table shows the year by year total land herbicided and consequently removed from production from each of the land use categories.

YEAR	TOTAL AREA HERBICIDED 10 ⁴ acres	CITY LAND AFFECTED 10 ² acres	AGRICULTURAL LAND OUT OF PRODUCTION 10 ⁴ acres	FOREST LAND OUT OF PRODUCTION 10 ⁴ acres	MANGROVE LAND OUT OF PRODUCTION 10 ⁴ acres
1965	22.2	.4	6.5	3.0	.42
1966	84.3	1.5	10.2	13.0	9.6
1967	170.8	2.8	22.1	26.0	19.8
1968	133.1	2.6	6.4	24.0	6.9
1969	128.7	2.4	6.6	22.6	9.0
1970	25.3	.6	3.3	4.2	1.2

3. Rouse Plowing Operation.

With available information 350,000 acres of forest land were estimated as being cleared from 1968 to 1970 by the Rouse Plow Operation. Westing and Pfeiffer (1971 and 1972) have calculated the area of plowed land at approximately 750,000 acres. They further estimate that of this "126,000 acres (were) of prime timberlands accessible to lumber operations, and 2,500 acres of producing rubber trees." These figures do not include prime timber land that is not accessible to lumber mills but contributes to the total energy budget of South Viet Nam. It was assumed that 350,000 acres of forests and 90,000 acres of agricultural land were cleared by the Rouse Plow Operation. The land areas cleared each year were assumed to be equal, because it was assumed the operation proceeded at a constant rate.

YEAR	AGRICULTURE LAND 10 ⁴ acres	FOREST LAND 10 ⁴ acres
1968	3.00	11.66
1969	3.00	11.66
1970	3.00	11.66

Appendix C

Imports (thousands of metric tons)

1965	2,159
1966	2,423
1967	2,269
1968	2,387
1969	3,469
1970	3,358 *

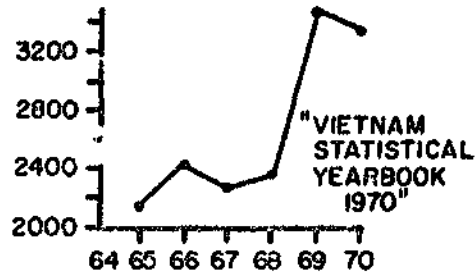

Fuel to South Vietnam (thous. metric tons) (partial data)

1966	1.005 ^{2.}
1967	0.862 ^{2.}
1968	1.062 ^{1.}
1969	1.128 ^{1.}
1970	1.210 ^{1.*}

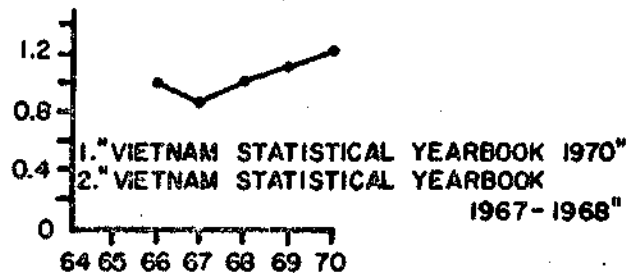

Money Spent for Goods & Fuel by Vietnam (import arrivals) (millions U.S. \$)

1965	387.7
1966	607.2
1967	744.0
1968	707.5
1969	837.7
1970	715.1

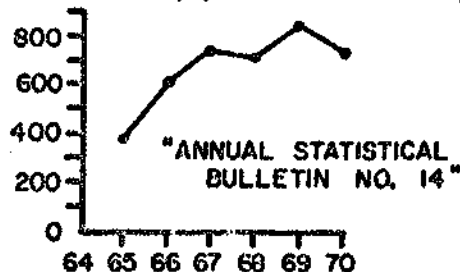

Structure Destroyed by War (thousands of acres)

1965	2.12
1966	7.34
1967	12.12
1968	12.87
1969	8.89
1970	4.54

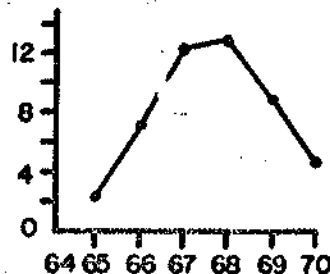

* Only six month figures were given for these years, so figure was doubled for year total.

Sources

1. "Annual Statistical Bulletins," Office of Joint Economic Affairs, U.S. AID, Vietnam. Vols. 11, 12, 13, 14.
2. A. P. Wire Service. Gainesville Sun. Gainesville, Florida. April 2, 1972.
3. Aviation Week and Space Technology. November 29, 1965.
4. Aviation Week and Space Technology. Jan. 3, 1966.
5. Background Material Relevant to Presentations at the 1970 Annual Meeting of the AAAS, Herbicide Assessment Commission of the American Association for the Advancement of Science. Maselson, Vesting, Constable, Revised. 1/4/71.
6. Congressional Record. Senate. January 28, 1972.
7. "Impact of the Vietnam War." Committee print by Foreign Affairs Division, Congressional Research Service, Library of Congress, U. S. Government Printing Office, Washington, 1971.
8. "Report on the War in Vietnam," Commander in Chief Pacific (as of 30 June, 1968). Superintendent of Documents, U. S. Govt. Printing Office, Wash., D.C.
9. Science. "Defoliation in Vietnam" Tschirley, Fred H., 21, Feb., 1969. p. 779-786.
10. U.S. Congress. House. Committee on Appropriations. Dept. of Defense Appropriations for 1970 pt. VII. Hearings, Washington, D. C. U. S. Government Printing Office. 1970. p. 395.
11. "Vietnam Subject Index Maps". Research files of the Engineer Agency for Resources, Inventories, and Vietnam Research and Evaluation Information Center. Bureau for Vietnam. January 1970.
12. Vietnam Statistical Yearbook 1970. National Institute of Statistics. Republic of Vietnam, Presidency of the Republic, Directorate General of Planning.
13. Banijubatana, Dusit. Mangrove Forest in Thailand. Proc. Ninth Pacific.
14. Golley, Frank, Odum, and Wilson. "The Structure and Metabolism of a Puerto Rican Red Mangrove Forest in May." Reprinted from Ecology, Vol. 43, No. 1, Winter, 1962.
15. Haitung, M. and G. H. Raets. 1968. Capacidad fisica y rendimiento de obreros forestal s en diferentes condiciones climaticas del tropico. Instituto forestal latino America De Investigacion y Capacitacion. Boletin No. 26:3-31.
16. Kellman, M. C. 1970. Secondary plant succession in tropical montane Mundanao. Australia National University, Canberra. 174 p.

17. Odum, E. P., Ecology. Holt, Rinehart and Winston, N. Y. 1963.
18. Odum, H. T. Environment Power and Society. John Wiley and Sons. N.Y. 1971.
19. Orians, Gordon H. and E. W. Pfeiffer. "Ecological Effects of the War in Vietnam." Science, 168, 5931:544-554. 1 May 1970.
20. Pfeiffer, E. W. and A. Westing. "Land War. Three Reports." Environment, Vol. 13, No. 9. Nov. 1971. p. 2-15.
21. Rodin, L. E. and N. I. Bazilevic. 1967. Production and Mineral Cycling in Terrestrial Vegetation. Oliver and Boyd, Edinburgh. p. 288.
22. Snedaker, S. C. 1970. Ecological Studies on Tropical Moist Forest Succession in Eastern Lowland Guatemala. Ph. D. Thesis, University of Florida. 131 p.
23. Tergaa, L. E. 1965. Correlation of nutrient availability in soil and uptake by native vegetation in humid tropics. M.S. Thesis. Univ. of Fla., 64 p.
24. Thayer, George. The War Business. Simon and Schuster. New York. 1969.
25. Westing, Arthur K. and E. W. Pfeiffer. "The Cratering of Indochina." Scientific American. Vol. 226 #5. May 1972. p. 21
26. Ewel, John J. 1970. Experiments in Arresting Succession with Cutting and Herbicides in Five Tropical Environments. Ph.D. dissertation. University of North Carolina, Chapel Hill. Unpublished.
27. Richey, Jeffery E. 1970. The Role of Disordering Energy in Microcosms. Masters of Science Thesis. University of North Carolina, Chapel Hill. Unpublished.

7. Simplified Simulation Model of Vietnam and the Impact of Herbicides

J. Zucchetto

In Fig. 1 is a simplified version of the more complex model of Vietnam given in Section 6. Fig. 1 has agriculture, non-human ecosystems, and urban settlements that depend on outside sources of natural energies, purchase of fuels, purchase of goods and services inputs, inflow of money with U.S. aid, inflow of war equipment and disruption of war equipment by communist energies. The model has the feedback of disrupted structures to a storage of disordered parts (e.g., land destroyed by bombs and herbicides) that react with available energies to produce net structure. Table 1 has a translation of the equations in Fig. 2 which mathematically describe the system configuration in Fig. 1.

From the data that were assembled for the larger descriptive model, storages and flow rates were estimated and these were used for the pathway coefficients as given in Tables 1 and 2. The scaled equations are given in Table 3 along with the scaling factors in Table 4.

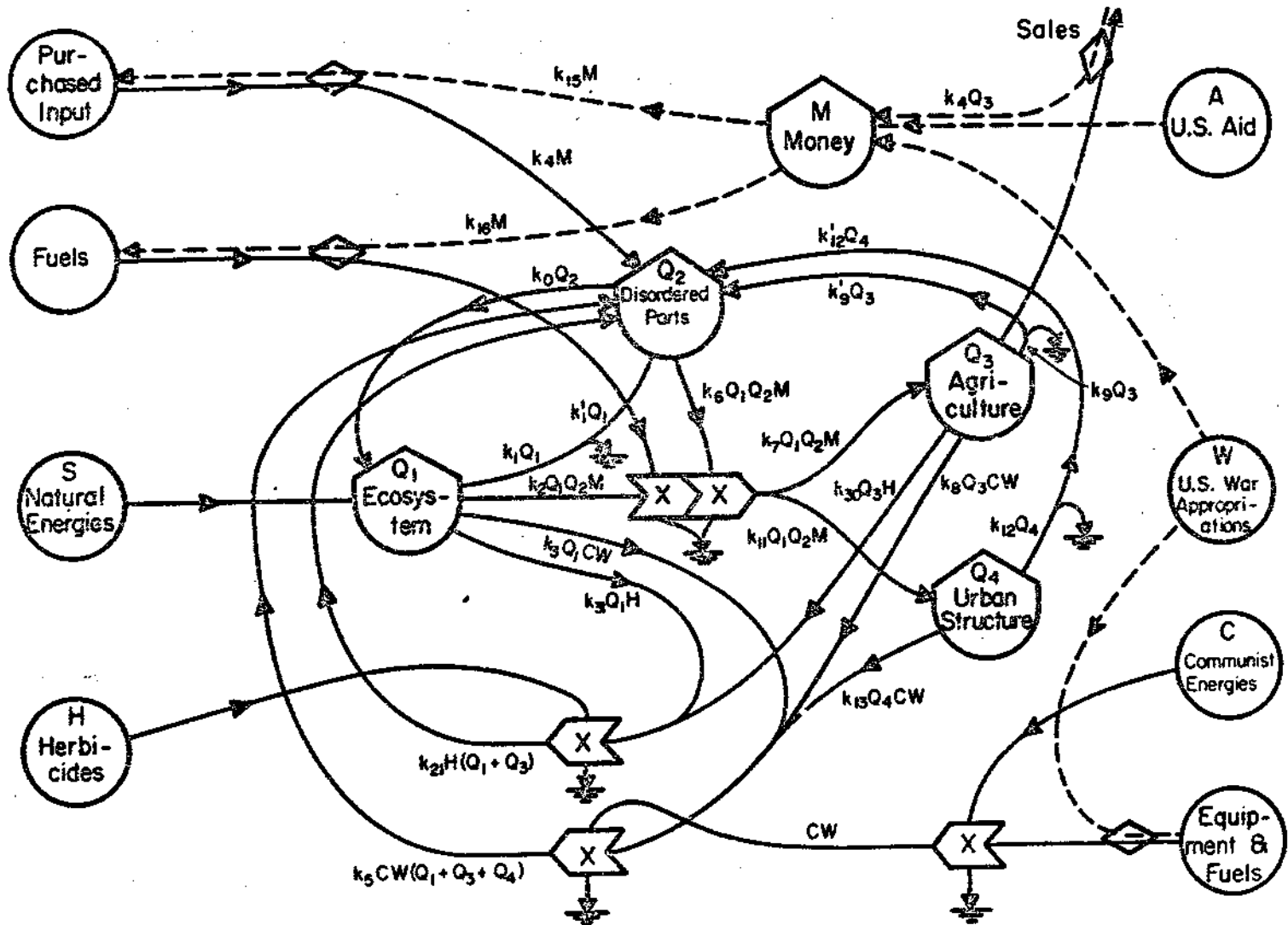

Figure 1.

General Equations

$$\dot{Q}_1 = S + K_0 Q_2 - K_3 Q_1 CW - K_1 Q_1 - K_{31} Q_1 H - K_2 Q_1 Q_2 M$$

$$\dot{Q}_2 = K_4 M + K_5 CW (Q_1 + Q_3 + Q_4) + K_{21} H (Q_1 + Q_3) - K_6 Q_1 Q_2 M$$

$$\dot{Q}_3 = K_7 Q_1 Q_2 M - K_8 Q_3 CW - K_9 Q_3 - K_{30} Q_3 H$$

$$\dot{Q}_4 = K_{11} Q_1 Q_2 M - K_{12} Q_4 - K_{13} Q_4 CW$$

$$\dot{M} = K_{14} Q_3 + A - K_5 M - K_{16} M + W$$

Fig. 2.

Table 1

	Description	Tank Levels, Flows & Calculations	Source of Information
Q_1	Ecosystem Lands (Upland Forest and Mangrove)	19.19×10^6 Acres	D.O.D. and Vietnam Statistic Year Book (See Footnotes)
Q_2	Disordered Parts (Forest, Agriculture and City)	25×10^4 Acres	
Q_3	Agricultural Land	7.31×10^4 Acres	
Q_4	Urban Land	2.47×10^4 Acres	
M	Capital in City	\$281 Million	
H	Herbicide Use	644×10^3 Gallons/Yr.	
C	Communist Energies	\$555 Million/Yr.	
$K_{11} Q_1 Q_2 M$	Rate of Growth of Urban Land	1235 Acres/Yr.	
$K_7 Q_1 Q_2 M$	Bare Forest Land Returning to Agriculture	5600 Acres/Yr.	
$K_8 Q_3 CW$	Assume 50% of Agricultural Land Replanted	4.5×10^4 Acres/Yr.	
$K_3 Q_1 CW$	Ecosystem Land Destroyed	7.95×10^3 Acres/Yr.	
W	U.S. War Appropriations	\$200 Million/Yr.	
A	U. S. Aid	\$250 Million/Yr.	
$K_4 M$	Purchased Input	\$50.3 Million/Yr.	
$K_5 CW(Q_1 + Q_3 + Q_4)$	Structure Destroyed	40×10^3 Acres/Yr.	
$K_{14} Q_3$	Money in due to Sales	\$40.5 Million/Yr.	

Table 1 (Cont.)

Description	Peak Levels, Flows & Calculations	Source of Information
$(K_{15} + K_{16})M$	\$130.5 Million/Yr.	D.O.D. and Vietnam Statistical Yearbook
$K_{16}M$	\$80.5 Million/Yr.	
$K_9 Q_1 Q_2 M$	14,500 Acres/Yr.	
$K_{11} Q_1 Q_2 M$	1235 Acres/Yr.	
$K_7 Q_1 Q_2 M$	5600 Acres/Yr.	
$K_8 Q_3 CH$	4.5×10^6 Acres/Yr.	
$K_0 Q_2$ Rate of Return of Disordered Land to Natural Land	1.25×10^6	
$K_{31} Q_1 H$ Ecosystem Herbicide Destruction	1.5×10^5 Acres/Yr.	
$K_{30} Q_3 H$ Agricultural Herbicide Destruction	5.94×10^6 Acres	
$K_{21} H(Q_1 + Q_3 + Q_4)$ Total Herbicide Destruction	21×10^6 Acres/year	
$K_{13} Q_4 CH$ Urban Bomb Destruction	890 Acres/Yr.	
$K_2 Q_1 Q_2 M$ Total Ecosystem Transformation into Rural and Urban	6835 Acres/Yr.	
$K_8 Q_3$ Depreciation	.02 Q_3 /Yr.	
$K_{12} Q_4$ Depreciation	.02 Q_4 /Yr.	

Footnotes for Table 1

Figures are approximately 1965-66 values.

Assume that the natural energies balance the losses to maintain a steady-state in the natural system. Thus,

$$S = K_1 Q_1 \text{ where it is assumed that } K_1 Q_1 = 0.02 Q_1 = 2\% \text{ of } Q_1/\text{year}$$

Storages:

Q_1 : Ecosystem lands - Upland forests	$\approx 18.5 \times 10^6$ acres
Mangrove	$\approx 0.691 \times 10^6$ acres
	<hr/>
	19.19×10^6 acres

Q_2 : Disordered parts - Bombed

Agriculture:	31,000 acres
Forest:	9,030 acres in craters
City:	890 acres
	<hr/>
	4.092×10^4 acres

Herbicided

Forest:	150,000 acres
Agriculture:	5.94×10^4 acres
	<hr/>
	21×10^4 acres
TOTAL: Q_2	$\approx 25 \times 10^4$ acres

Q_3 : Agricultural land $\approx 7.31 \times 10^6$ acres

Q_4 : Urban land $\approx 2.47 \times 10^4$ acres

M: Capital in city \approx \$281 million

Herbicide use - Agricultural land:	198×10^3 gallons
Upland forest:	455×10^3 gallons
Mangroves:	11×10^3 gallons
	<hr/>
	644×10^3 gallons

C: Communist energies - 140,000 men or \$555 million

Flows in System:

Rate of growth of urban land: $K_{11} Q_1 Q_2 M \approx 1235$ acres/yr.

Bare forest land returning to agriculture: $K_7 Q_1 Q_2 M \approx 5600$ acres/yr.

Footnotes for Table 1 (Continued)

Assume 50% of agricultural land replanted. Thus,

$$K_8 Q_3 CW = 0.5 [3.1 \times 10^4 + 5.94 \times 10^4] = 4.5 \times 10^4 \text{ acres/yr.}$$

Ecosystem lands destroyed:

$$K_3 Q_1 CW = 0.05 [(9.03 + 150) \times 10^3] = 7.95 \times 10^3 \text{ acres/yr.}$$

War appropriations from U.S.:

$$W = \$200 \text{ million}$$

U. S. aid:

$$A = \$250 \text{ million}$$

Purchased input amounts to:

$$K_4 M = \$50.3 \text{ million}$$

Amount of structure destroyed:

$$K_5 CW [Q_1 + Q_3 + Q_4] = 40 \times 10^3 \text{ acres/yr.}$$

Amount of money flowing in due to sales:

$$K_{14} Q_3 = \$40.5 \text{ million}$$

The amount of money flowing out to purchase goods and fuel:

$$(K_{15} + K_{16})M = \$130.5 \text{ million} \quad K_{16}M = \$80.5 \text{ million}$$

Bare land returning to agriculture:

$$K_6 Q_1 Q_2 M = 14,000 \text{ acres/yr.}$$

Amount of natural land changing into urban land:

$$K_{11} Q_1 Q_2 M = 1235 \text{ acres/yr.}$$

Amount of natural land converted into agricultural land:

$$K_7 Q_1 Q_2 M = 5600 \text{ acres/yr.}$$

Rural destruction:

$$K_8 Q_3 CW = 4.5 \times 10^4 \text{ acres/yr.}$$

Rate of return of disordered land to natural land:

$$K_0 Q_2 = 1.25 \times 10^4 \text{ acres/yr.}$$

Footnotes for Table 1 (Cont.)

Ecosystem destruction due to herbicide:

$$K_{31}Q_1H \approx 1.5 \times 10^5 \text{ acres/yr.}$$

Agricultural land destroyed by herbicide:

$$K_{30}Q_3H \approx 5.94 \times 10^4 \text{ acres/yr.}$$

Total herbicide destruction:

$$K_{21}H(Q_1 + Q_2 + Q_4) \approx 21 \times 10^4 \text{ acres/yr.}$$

Urban bomb destruction:

$$K_{13}Q_4CW \approx 890 \text{ acres/yr.}$$

Total bomb destruction:

$$K_5CW(Q_1 + Q_3 + Q_4) \approx 40 \times 10^3 \text{ acres/yr.}$$

Total ecosystem transformation into rural and urban:

$$K_2Q_1Q_2M \approx 1235 + 5600 = 6835 \text{ acres/yr.}$$

Assume approximately 2% recycle into Q_2 from Q_1 , Q_3 and Q_4 : i.e. $K_1 \approx K_9 \approx K_{12} \approx 0.02$

Table 2

 Coefficient values:

K_0	$=$	0.05
K_2	$=$	0.355×10^{-3}
K_3	$=$	0.373×10^{-8}
K_4	$=$	0.179
K_5	$=$	0.136×10^{-7}
K_6	$=$	0.104×10^{-10}
K_7	$=$	0.0403×10^{-10}
K_8	$=$	5.55×10^{-8}
K_{11}	$=$	0.0092×10^{-10}
K_{13}	$=$	32.5×10^{-8}
K_{14}	$=$	5.54×10^{-6}
K_{15}	$=$	0.179
K_{16}	$=$	0.286
K_{21}	$=$	0.79×10^{-2}
K_{30}	$=$	0.812×10^{-2}
K_1	$=$	$K_9 = K_{12} = 0.02$

Table 3. Scaled Equations

$$\frac{Q_1}{10^6} = .384 [S] + .5 [Q_2] - .134 (10) [Q_1][C][W] - 30 K_1 [Q_1] - .234 [Q_1][H] - .15 (100)[Q_1][Q_2][M]$$

$$\begin{aligned} \frac{Q_2}{.33 \times 10^6} &= .14 [M] + .5 [C][W] (.3 [Q_1] + .0098 [Q_3] + .0098 [Q_4]) + .5 (.142(100)[Q_1] + .475 [Q_3]0[H] \\ &- .938(100)[M][Q_2][Q_1] + .18(10)[Q_1] + .06(10)[Q_3] + .06[Q_4] \end{aligned}$$

$$\frac{Q_3}{.33 \times 10^6} = .365(100)[M][Q_1][Q_2] - .2(100)[Q_3][C][W] - 30 K_8 [Q_3] - .244 [Q_3][H]$$

$$\frac{Q_4}{.33 \times 10^5} = .11(1000)[Q_1][Q_2][M] - 30 K_{12} [Q_4] - .117(1000)[Q_4][C][W]$$

$$\frac{M}{.33 \times 10^3} = .166 [Q_3] + .15(10)[A] - .86(10)[M] - .86(10)[M] + .18(100)[W]$$

Maximum Values:

$$Q_{1m} = 30 \times 10^6$$

$$Q_{3m} = 10^7$$

$$C_m = 2 \times 10^3$$

$$A_m = 500$$

$$Q_{2m} = 10^7$$

$$M_m = 10^4$$

$$W_m = 6 \times 10^3$$

$$H_m = 1$$

Table 4
Scaling Factors

$$\frac{Q_1}{30 \times 10^6}$$

$$\frac{Q_2}{10^7}$$

$$\frac{Q_3}{10^7}$$

$$\frac{Q_4}{10^6}$$

$$\frac{M}{10^4}$$

$$\frac{C}{2 \times 10^3}$$

$$\frac{W}{6 \times 10^3}$$

$$\frac{R}{1}$$

$$\frac{Q_3^{CW}}{12 \times 10^{13}}$$

$$\frac{Q_1^{CW}}{360 \times 10^{12}}$$

$$\frac{Q_4^{CW}}{12 \times 10^{12}}$$

$$\frac{MQ_2 Q_1}{30 \times 10^{17}}$$

$$\frac{Q_1^H}{30 \times 10^6}$$

$$\frac{MQ_2}{10^{11}}$$

$$\frac{Q_3^H}{10^7}$$

Results of Computer Runs

In the first run (Fig 5) the system was not pulsed with a 5-year input of herbicides. As can be seen from Fig. 5 the various state variables in the model eventually achieve a steady state value, the urban sector taking the longest to achieve steady state. Notice in Figs. 6 and 7 that the effects of a 5-year herbicide pulse or a double intensity 10-year herbicide pulse produce perturbations in the system variables during the first 10-15 years, a time during which the rates of change are different than in Fig. 5. The system has enough inherent stability to damp out the perturbations and to eventually proceed to similar steady state values irregardless of whether there was a herbicide pulse. The interesting question arises as to the limits of herbicidal disordering and destruction beyond which the system would not recover and a completely new steady-state situation would result. Of course, the stability and recovery of the system are linked to the input of natural energy (solar to photosynthetic growth) and fossil-fuel and resource energy. Without these order-directing pathways the system, under intense destructive energies, would end in disorder with a much slower recovery rate.

Fig. 8 presents results under the assumption that there is no flow, $K_0 Q_2$, from Q_2 (disordered parts) to Q_1 (natural ecosystem). This situation might arise if a political decision is made to develop the devastated natural areas. The system recovers to the same steady-state values as before except for ecosystem lands which end up at a lower value (app. 16% lower). It is interesting to notice in all the graphs that urban development follows a kind of pseudo-logistic curve even though there is only a linear depreciation outflow and a constant yearly rate of energy input (U.S. aid). The question arises as to what kind of growth will arise if there is a square term depreciation outflow from Q_4 .

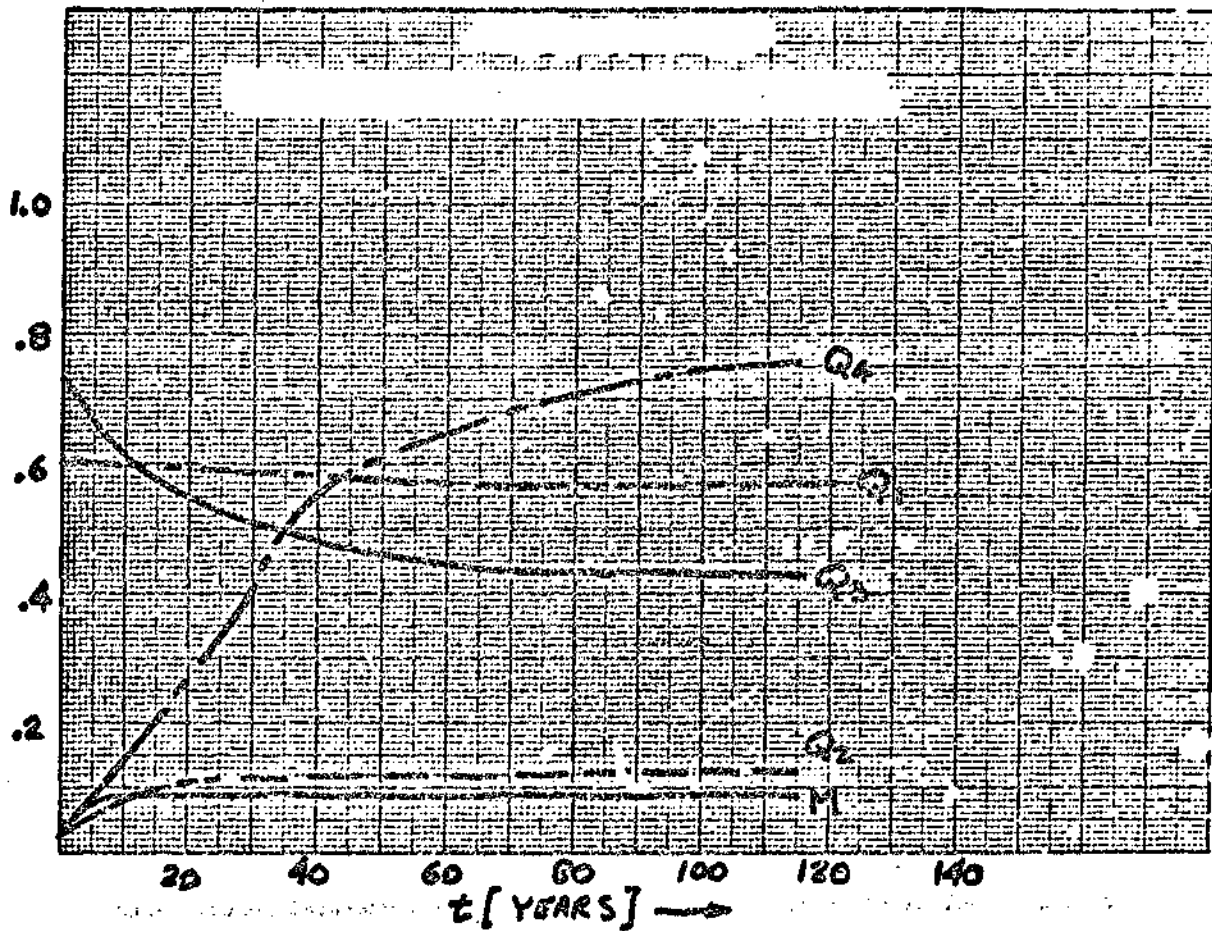

Figure 5. No herbicide; 15-year war pulse.

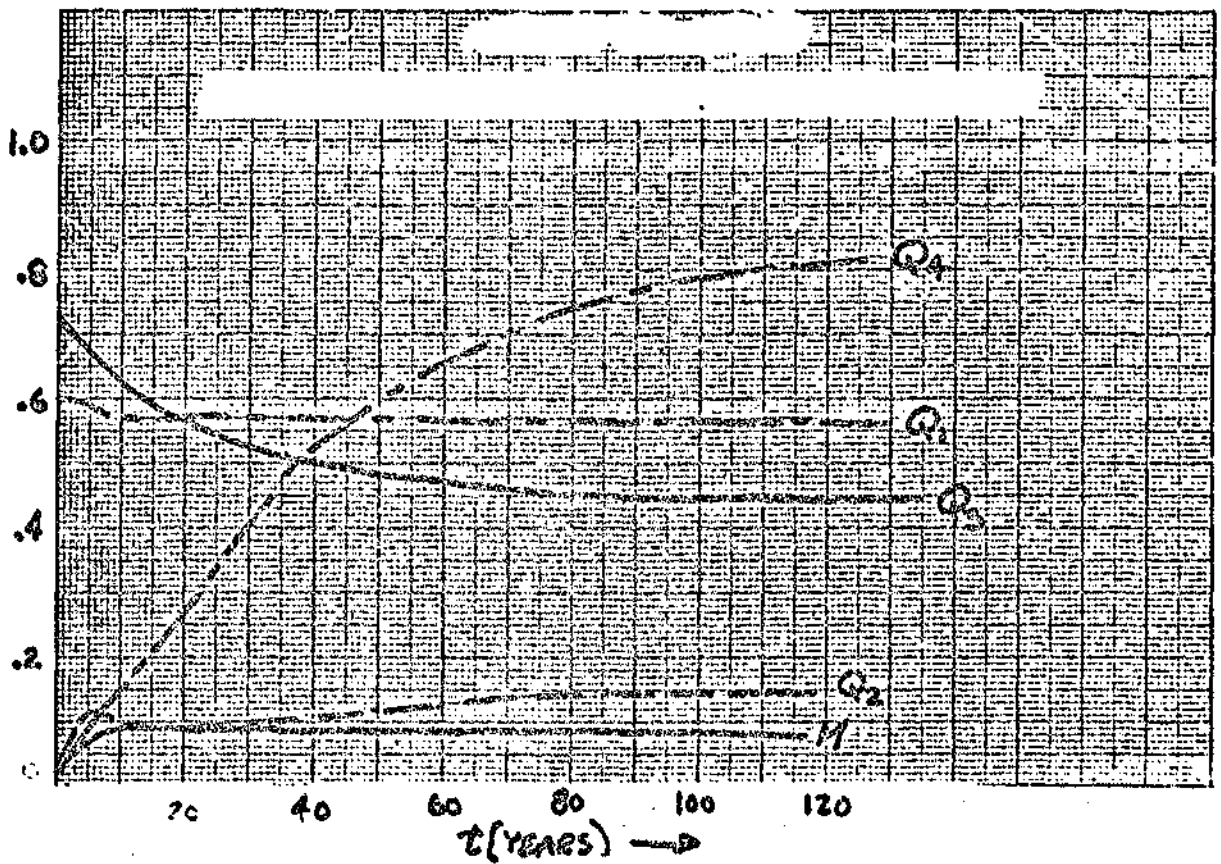

Figure 6. Five-year herbicide pulse; 15-year war pulse.

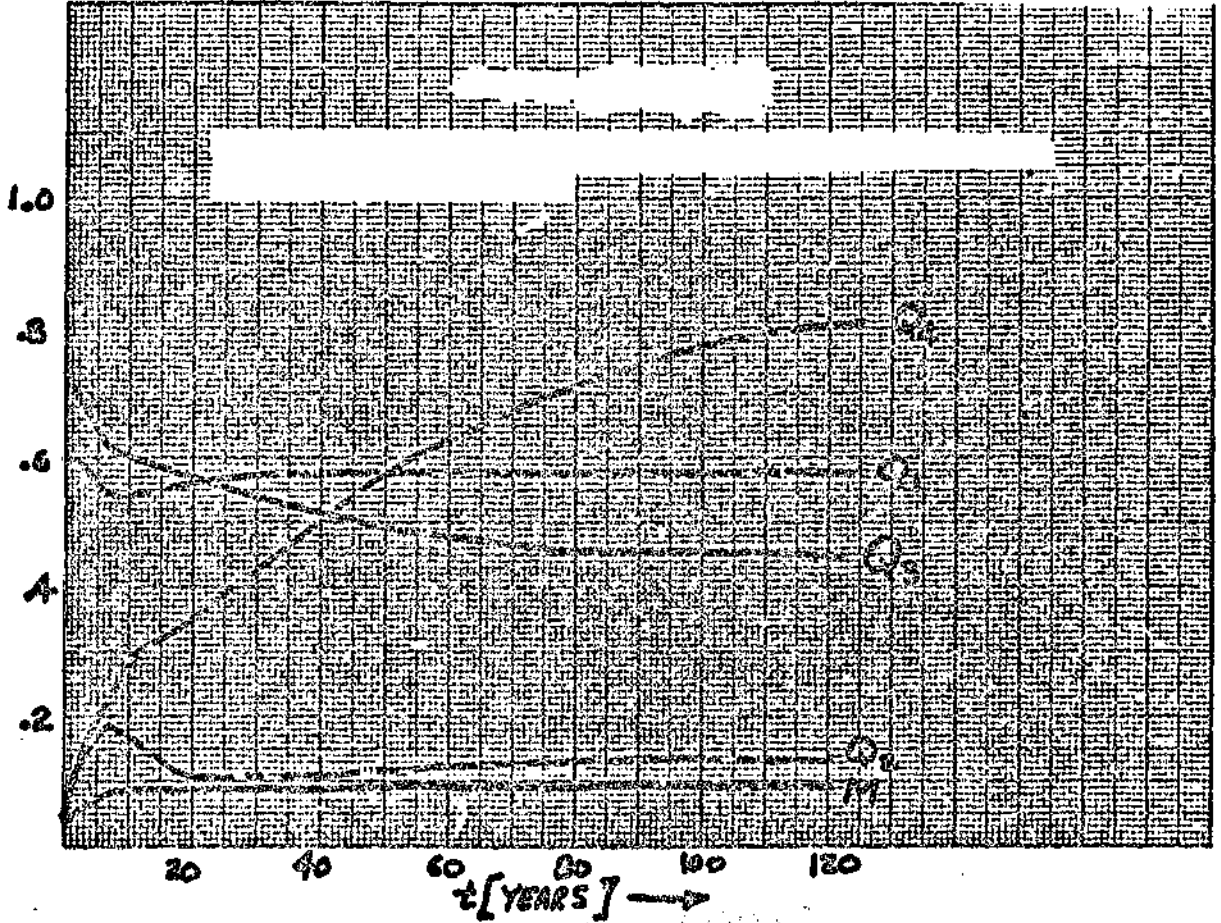

Figure 7. 10-year double intensity pulse of herbicide; 15-year war pulse.

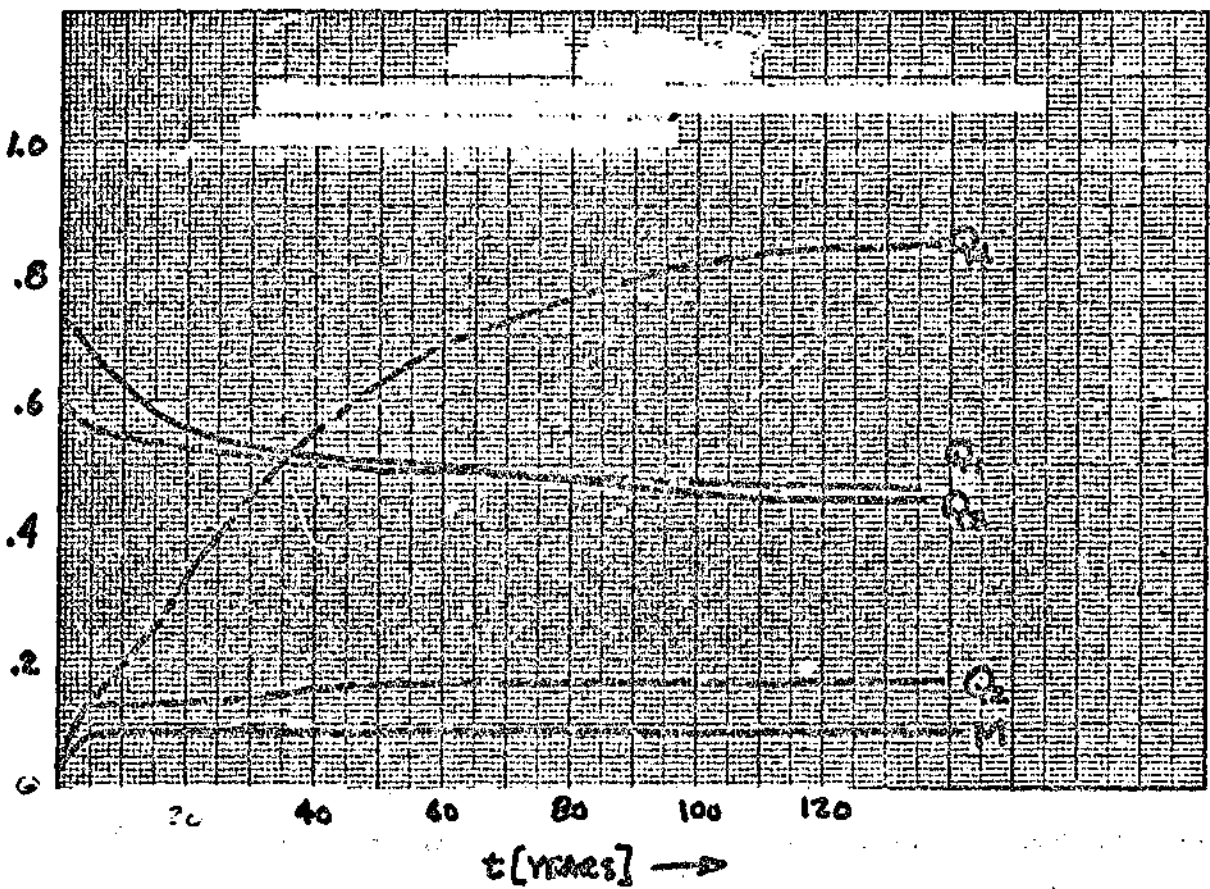

Figure 8. Five-year herbicide pulse; 15-year war pulse, no natural recovery.

i.e., that the costs of maintaining a complex system at some level increase as the square of the interactions among the parts. Fig. 11 illustrates the response with a KQ_4^2 outflow from the Q_4 storage.

Since the development and recovery of the system is so dependent on U.S. aid, i.e., on fuels and resources, it is interesting to look at the response of the system under different levels of subsidy. In Figs. 9 and 10 are the results for urban and agricultural growth for three different levels of U.S. aid. As can be seen there is not a linear correspondence between U.S. aid and growth. In fact, there seems to be a process of diminishing returns taking place in that the percentage increase in growth is decreasing with equal increments of U.S. aid. This effect was definitely seen for the agricultural growth in that there was virtually no change between 10 times and 30 times the base level of U.S. aid. Both Figs. 9 and 10 assume that there is no natural recovery from Q_2 to Q_1 .

Perspective in Comparison of Herbicide Impact with Other Disruptions

Examination of the simulation curves suggest magnitudes of impact of the herbicide spraying period on the total energy flow of the Vietnam system. As shown in Fig. 6 the percentage of energy lost, as a fraction of the area under the disordered parts curve until steady-state is reached, is approximately 5-6%. The impact of herbicides exerts a short range effect, damping out within a period of 5 years, as long as foreign aid is stimulating reordering.

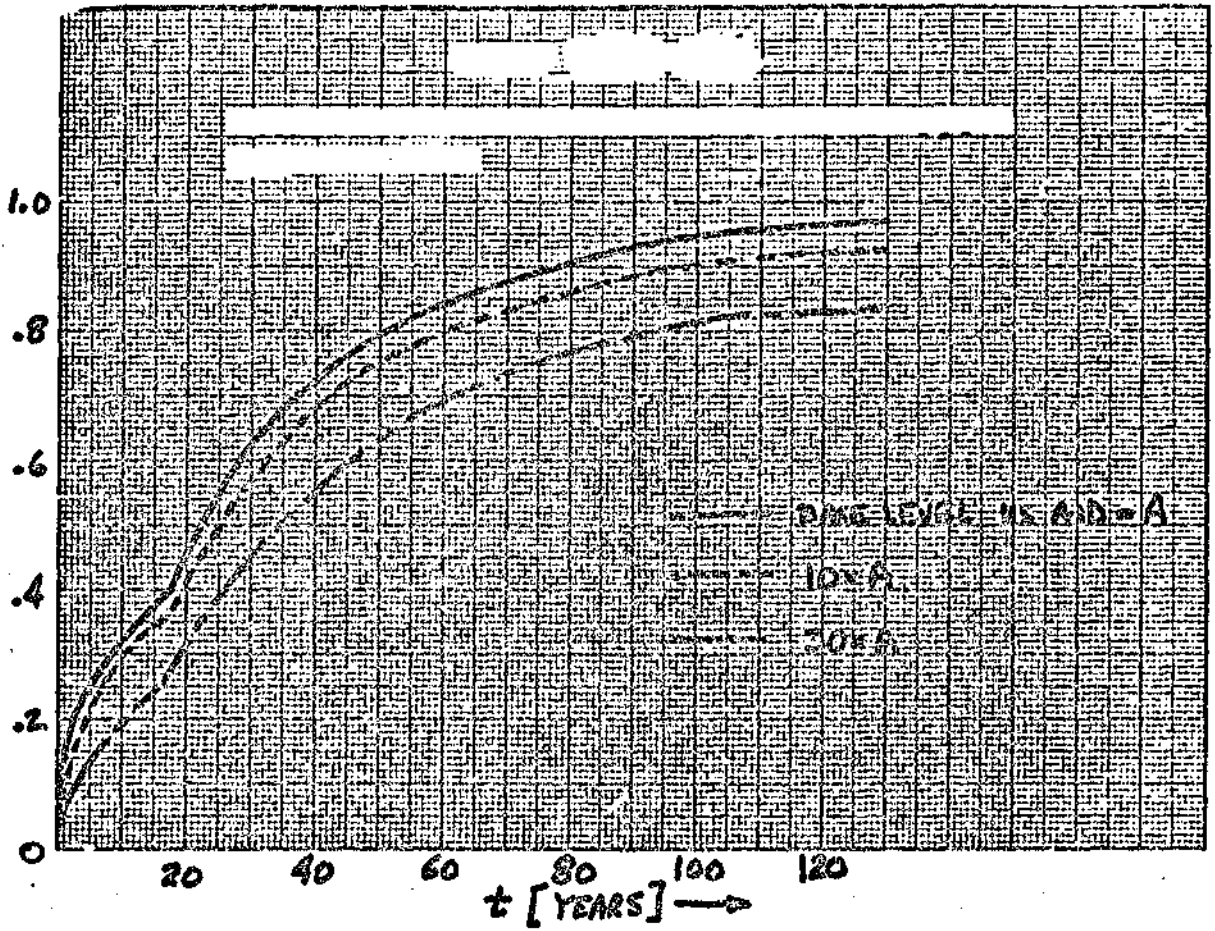

Figure 9. Urban growth for 3 different levels of U.S. aid.

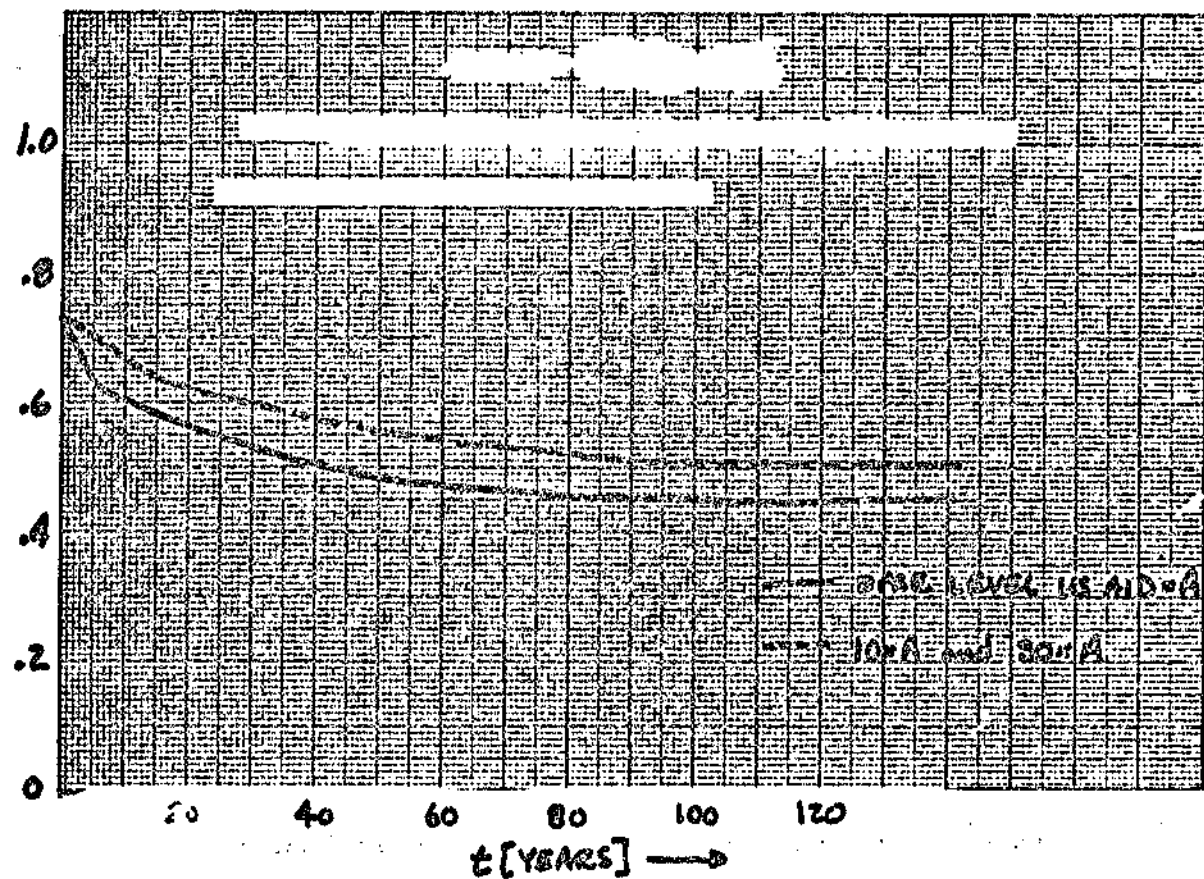

Figure 10. Agricultural growth for different levels of U.S. aid.

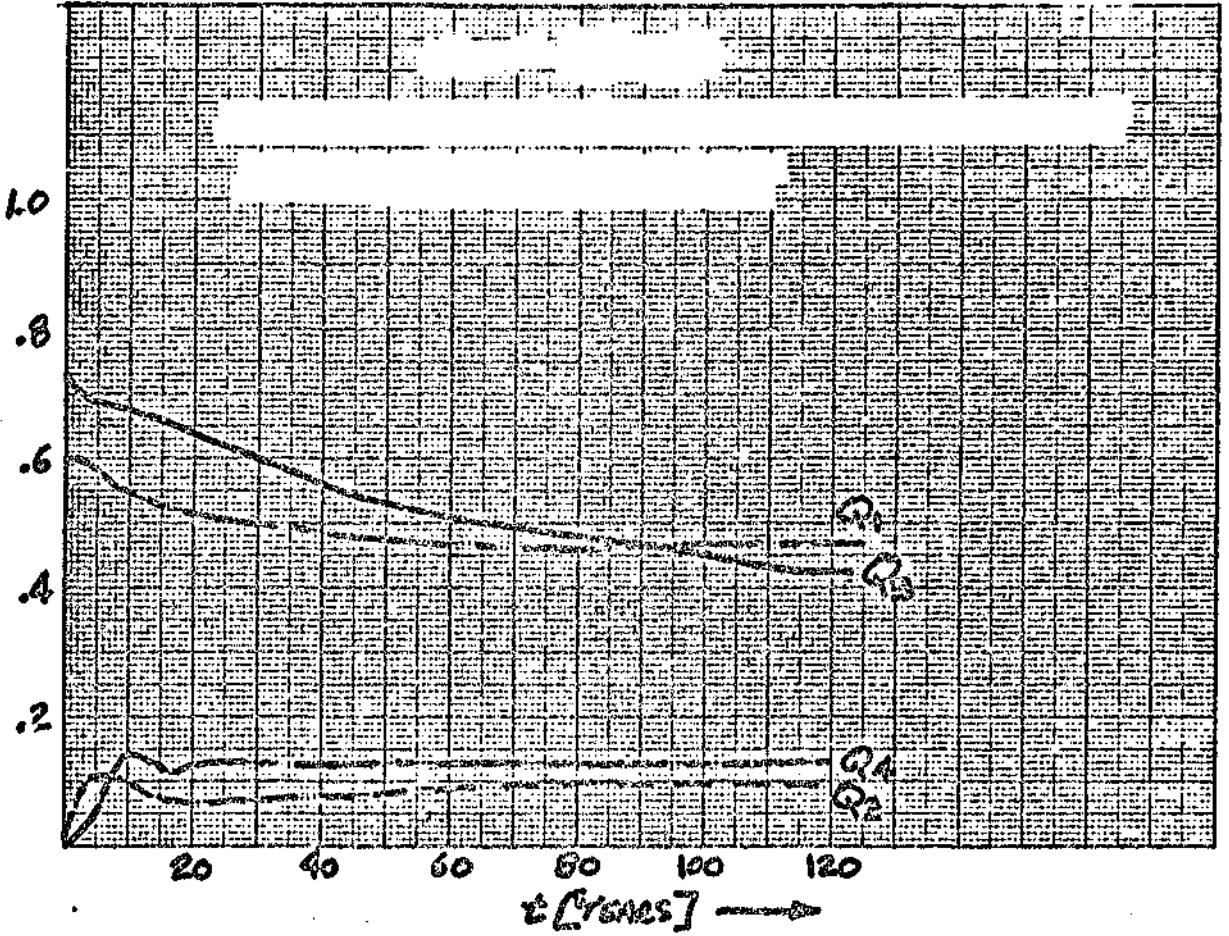

Figure 11. Five-year herbicide pulse; 15-year war pulse, Q_1^2 outflow from Q_4 .

8. A SIMPLIFIED SIMULATION OF THE IMPACT OF HERBICIDE AND
WAR ON PRODUCTIVITY IN VIETNAM

C. SWALLOWS

The destruction caused by war has a functional relationship with those materials which have not been affected nor destroyed. In energy terms, the stress of war upon structure creates disordering energies which interact with ordering energies to assist the reestablishment of order. For example, natural biodegradation processes generate nutrients from the organic matter of fallen trees which will assist in the fertilization of the soil for the benefit of future trees and other plant life.

The disordering energy in effect catalyzes the ordered energies directed to form new structure. This formation of new structure is a function of the rate of catalyzation which in turn is a function of the quantity of the disorder generated and the ordered energy available for the catalytic process.

A basic model of the Vietnam conflict is shown in Fig. 1. It depicts basic interactions among the various components of war, structure, disorder, and ordered energy.

The application of stress upon the structure will obviously decrease the quantity of the structure, but what effects does the stress have upon recovery time and the steady-state levels?

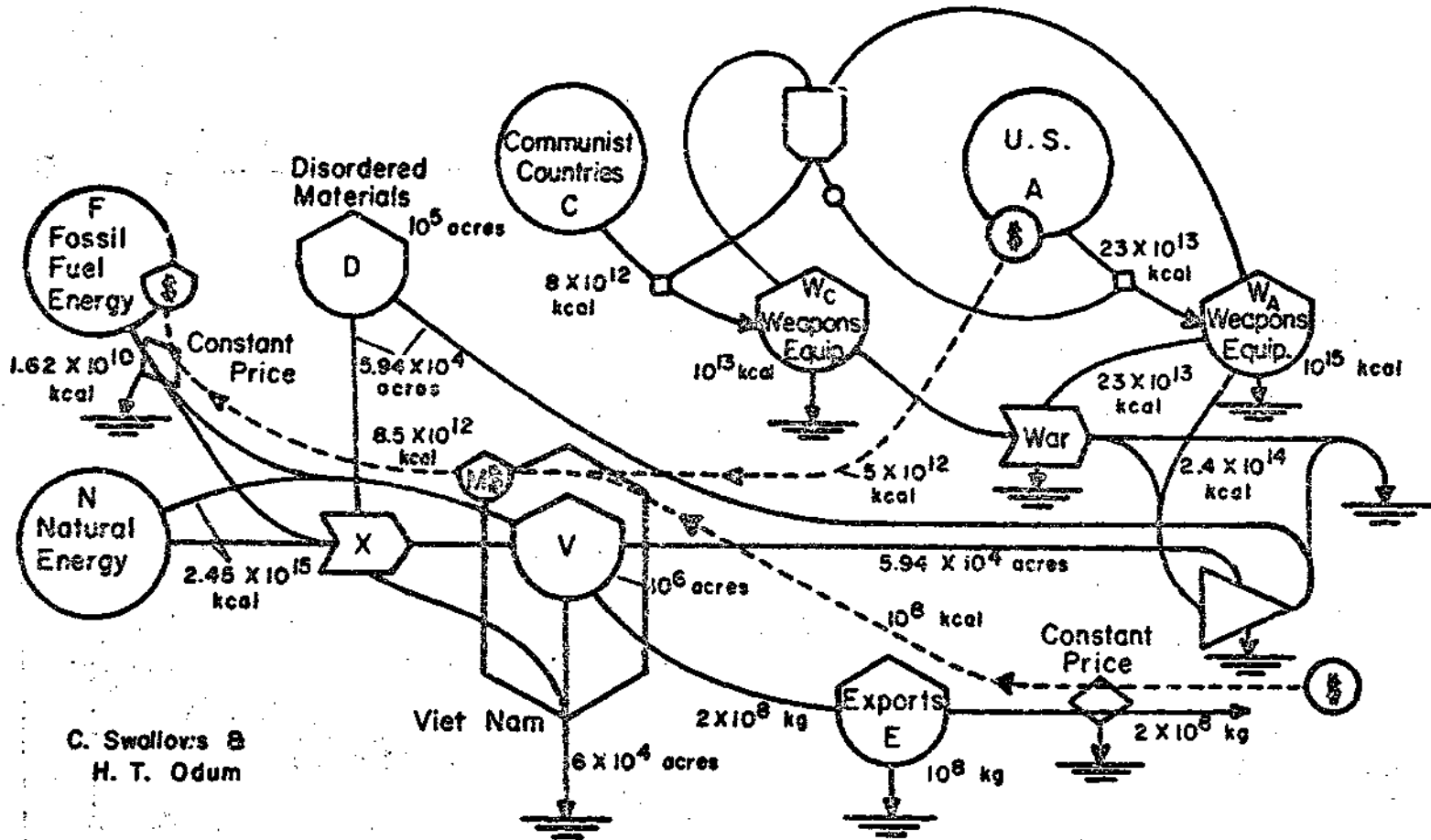

Figure 1.

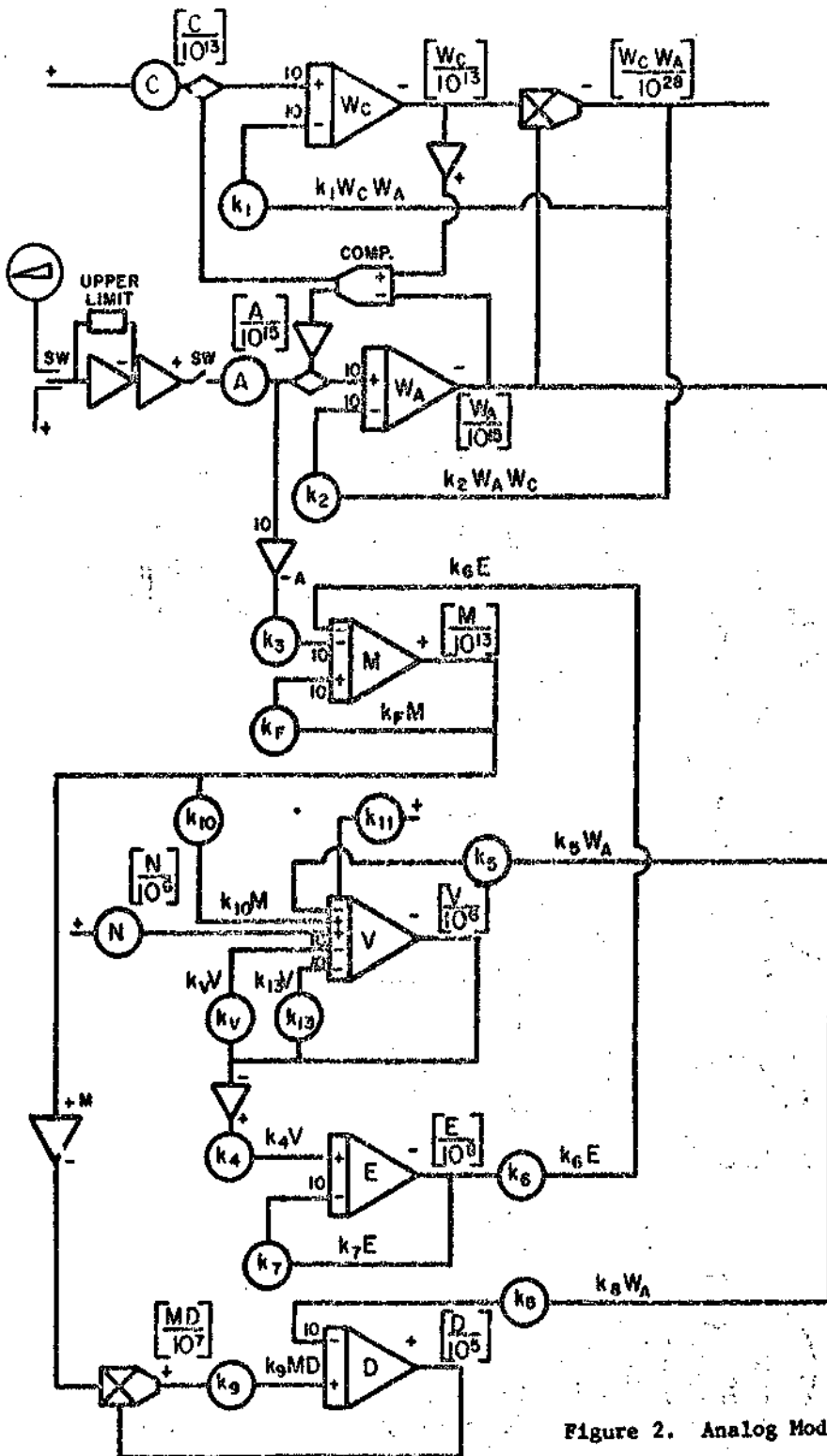

Figure 2. Analog Model

In the agrarian system of Vietnam, the productivity of forest land and agricultural land has been a primary basis for that society. What was the quantitative role of herbicide in forest and agricultural productivity? How long were lands rendered unproductive? How fast were repair mechanisms released? How rapidly were bared lands and released nutrients accelerating successions and regrowth?

In this section two models are evaluated and simulated to suggest regrowth patterns for the forests and agricultural uplands of Vietnam.

Productivity Model One

The model shown in fig. 1. is a macroscopic view of the Vietnam conflict which depicts the order-disorder symbiotic process. In order to simplify the complex interactions within productivity, the available agricultural and forest acreage was lumped into a single storage without consideration of spatial relationships. The forcing functions which contributed to the growth and stability were natural energy and included some fossil fuel subsidies to the rural economy. These forcing functions are shown interacting with the disordering energy to reestablish disordered land to productive land. Exports provide income and the model assumes constant price; earnings go for fuel. Financial subsidies from the United States are

shown further subsidizing natural energy.

The warring factions act as two large energy sources which match each other in the model as to the power they send into the war.

Differential Equations:

$$\dot{V} = N + K_{10}M - K_5W_A - K_VV - K_{13}V$$

$$\dot{E} = K_4V - K_7E$$

$$\dot{D} = K_8W_A - K_9MD$$

$$\dot{M} = K_3A + K_6E - K_{FM}$$

$$\dot{W}_O = C - K_1W_OW_A$$

$$\dot{W}_A = A - K_2W_AW_O$$

Numbers used for scaling are given on the energy flows shown in Fig. 1 as obtained from the following Table 1. These numbers indicate the quantities which have flowed from the sources to the storages or from the storages to another storage.

Note that Tables 2 and 3 are footnotes of Table

4. These tables indicate the scaling procedure followed for this model. Table 4 shows the results of the scaling process.

Table 1*

Flow	Type of Flow	Quantity	Source
1	U.S. aid to Vietnam	5×10^{12} kcal	'Annual Statistical Bulletin #14'
2	Money spent for fuel by Vietnam	8.5×10^{12} kcal	'Annual Statistical Bulletin #14'
3	Fuel to Vietnam	1.62×10^{10} kcal	Vietnam Statistical Yearbook
4	Herbicide destruction of land	21×10^4 acres	Impact of Vietnam War
5	Exports	2×10^8 Kg	Vietnam Statistical Yearbook
6 & 7	U.S. war appropriations and effort	23×10^{13} kcal	Impact of Vietnam War
8	Herbicide application	2.4×10^{13} kcal	Impact of Vietnam War
9	Communist war effort	8×10^{12} kcal	
10	Natural energy	2.45×10^{15} kcal	**

*Numbers were derived from data paper by Mark brown (Part 6)

**For flow 10: Insolation:

$$(4000 \text{ kcal/m}^2/\text{day})(4000 \text{ m}^2/\text{acre})(6 \times 10^4 \text{ acres})(365 \text{ days/year}) \\ = 3.5 \times 10^{15} \text{ kcal/year}$$

Gross productin of disturbed cover is approximately 1% of insolation. Therefore, 3.5×10^{13} kcal/year.

For one acre of vegetation order:

$$(10,000 \text{ kcal/m}^2)(4000 \text{ m}^2/\text{acre}) = 4 \times 10^7 \text{ kcal/acre}$$

$$\text{Turnover: } \frac{3.5 \times 10^{15} \text{ kcal/year}}{4 \times 10^7 \text{ kcal/acre}} = 0.9 \times 10^8 \text{ acre/year}$$

therefore, the turnover rate is approximately once per year.

Table 2

Scaling

$K_{1AWC} = 10^{13}$	$k_1 = \frac{10^{13}}{(23 \times 10^{13})(8 \times 10^{12})} = 5 \times 10^{-15}$
$K_{2AWC} = 10^{13}$	$K_2 = \frac{10^{13}}{(10^{13})(8 \times 10^{12})} = 0.12 \times 10^{-12}$
$K_3A = 5 \times 10^{12}$	$K_3 = \frac{5 \times 10^{12}}{23 \times 10^{13}} = 0.022$
$K_4V = 2 \times 10^8$	$K_4 = \frac{2 \times 10^8}{10^9} = 0.2$
$K_5WA = 10^5$	$K_5 = \frac{10^5}{23 \times 10^{13}} = 4 \times 10^{-10}$
$K_6E = 10^8$	$K_6 = \frac{10^8}{10^8} = 1$
$K_7E = 10^8$	$K_7 = \frac{10^8}{10^8} = 1$
$K_8WA = 100$	$K_8 = \frac{10^2}{23 \times 10^{13}} = 4 \times 10^{-11}$
$K_9DM = 100$	$K_9 = \frac{10^2}{(6 \times 10^4)(0.5 \times 10^{12})} = 3.3 \times 10^{-14}$
$K_{10V} = 1.2 \times 10^{-3}$	$K_{10} = \frac{1.2 \times 10^{-3}}{6 \times 10^4} = 2 \times 10^{-8}$
$K_{13V} = 6 \times 10^4$	$K_{13} = \frac{6 \times 10^4}{6 \times 10^4} = 1$
$K_YM = 10^{12}$	$K_Y = \frac{10^{12}}{0.5 \times 10^{12}} = 2$
$K_VV = 2 \times 10^8$	$K_V = \frac{2 \times 10^8}{10^9} = 0.2$

Table 3

			Pot	Setting
C	$\frac{(8 \times 10^{12})(10^{13})}{(10^{13})(10^{13})} = 0.8$		11	0.8 (10)
A	$\frac{(23 \times 10^{13})(10^{15})}{10^{15}} = 0.23$		13	0.023 (10)
N	$\frac{10^6}{10^6} \frac{10^6}{10^6} = 1$		36	0.1 (10)
K ₁	$\frac{(5 \times 10^{-15})(10^{28})}{10^{13}} = 5$		15	0.5 (10)
K ₂	$\frac{(1.2 \times 10^{-13})(10^{28})}{10^{15}} = 1.2$		16	0.12 (10)
K ₃	$\frac{(0.022) 10^{15}}{10^{13}} = 2.2$		21	0.22 (10)
K ₄	$\frac{(0.2)(10^6)}{10^8} = 0.002$		33	0.002
K ₅	$\frac{(4 \times 10^{-10})(10^{15})}{10^6} = 0.4$		31	0.4
K ₆	$\frac{(1)(10^8)}{10^{10}} = 0.01$		35	0.01
K ₇	$\frac{1(10^8)}{10^8} = 1$		34	0.1 (10)
K ₈	$\frac{(4 \times 10^{-11})(10^{15})}{10^5} = 0.4$		24	0.04 (10)

Table 3 (Cont.)

			Pot	Setting
K_9	$\frac{(0.33 \times 10^{-13})(10^{18})}{10^5} = 0.3$		26	0.3
K_{10}	$\frac{(2 \times 10^{-8})(10^{13})}{10^6} = 0.2$		23	0.2
K_{13}	$\frac{(1)(10^6)}{10^6} = 1$		25	0.1 (10)
K_F	$\frac{2(10^{13})}{10^{13}} = 2$		22	0.2 (10)
K_V	$\frac{(0.2)(10^6)}{10^{13}} = 0.002$		32	0.002
K_{11}	Initial Condition		12	0.386

Table 4

Pot	Setting	Address
11	0.08 (10)	C
12	0.386	K ₁₁
13	0.023 (10)	A
14	-	Upper Limit
15	0.5 (10)	K ₁
16	0.12 (10)	K ₂
21	0.22 (10)	K ₃
22	0.2 (10)	K ₇
23	0.2	K ₁₀
24	0.04 (10)	K ₈
25	0.1 (10)	K ₁₃
26	0.3	K ₉
31	0.4	K ₅
32	0.002	K ₆
33	0.002	K ₄
34	0.01 (10)	K ₇
35	0.01	K ₆
36	0.01 (10)	N

The graphs resulting from simulations are shown in Figures 3, 4, and 5.

Since the starting condition was calculated with a steady-state diagram, Fig. 3 shows a constant, steady-state quantity of acreage available for production without herbicide and war. The steady-state quantity is approximately 0.4×10^5 acres and the financial status of the country remains low.

Fig. 4 depicts the effects of herbicide defoliation upon the components when the American war effort steadily increases. The steady-state value for productivity is approximately 0.2×10^5 acres which is one-half the steady-state value observed in Fig. 3. However, the capital in the country has increased due to the financial aid given by the United States. There is more money per capita relative to less production. Therefore, a higher standard of living accrues as result of the war if such available monies are distributed among the citizens.

Fig. 5 shows the transition to a new steady-state with a constant level of war effort. Herbicide applications reach steady state levels rapidly due to the constant American war effort. Note that the response time for herbicide is about 1.2 years whereas the transition period for productivity is about three years. This lag denotes the length of time in which the herbicide damage reaches steady-state with regrowth.

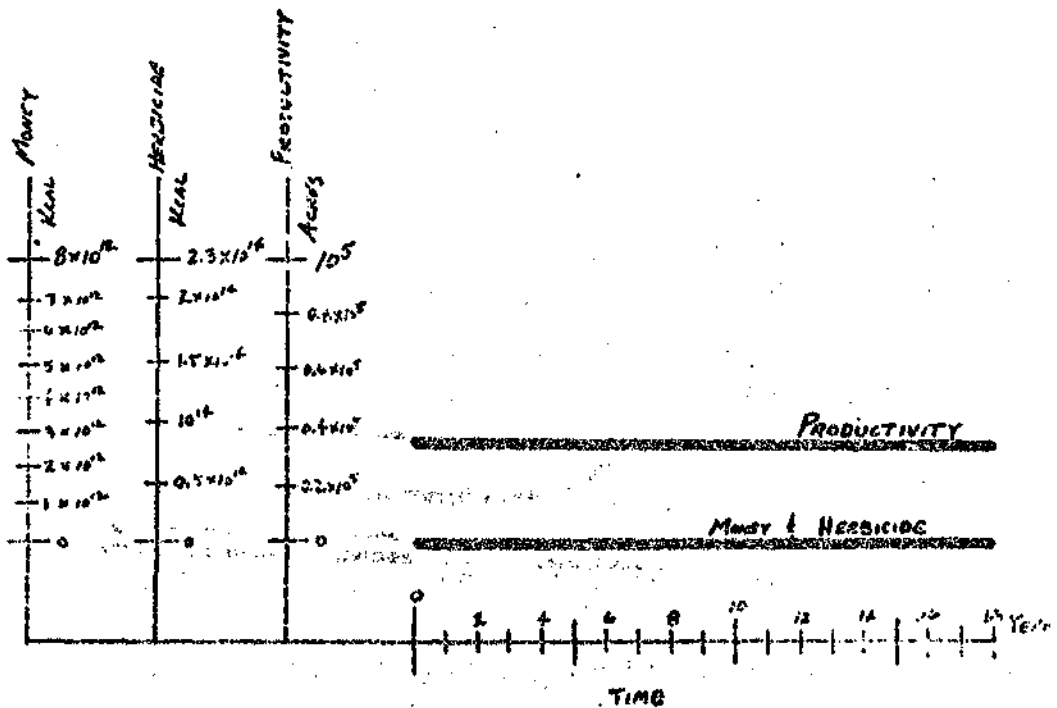

Figure 3. No War.

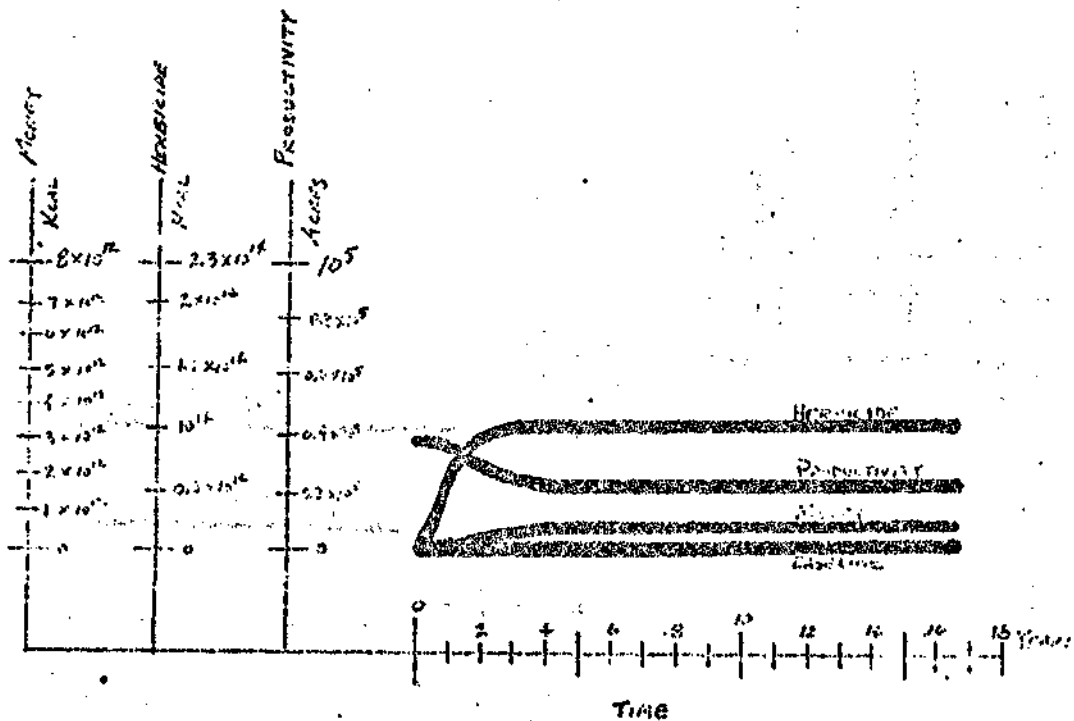

Figure 4. Gradually accelerating American War effort with an upper limit of 1.54×10^{13} kcal.

Reproduced from
best available copy.

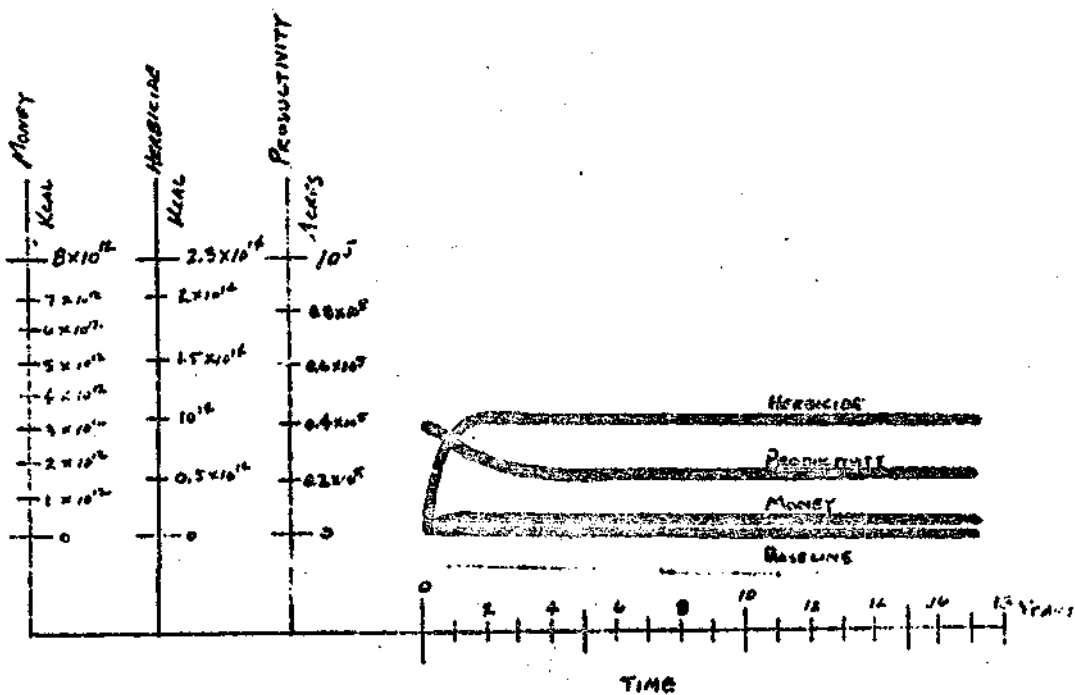

Figure 5. Constant American War Effort of 1.54×10^{13} kcal.

Productivity Model Two

As shown in the source graphs in section B., the application of herbicide in Vietnam followed a five year pulse. Such a pulse was simulated on a slightly modified model shown in Fig. 6. The graphs, shown in Figures 8 through 11, predict the steady-state levels of the various interacting components in productivity model two.

Fig. 8 shows the natural steady-state levels of productivity when there is no herbicide application. The values are the same as those in Fig. 3.

Figures 9., 10 and 10A. show the effect of the five year herbicide pulse upon Vietnam's financial status and productivity over different time periods. Figures 10. and 10A. also show the resulting quantities of disordered land within the system. Eventually, disorder will gradually return to zero but the surge of disorder and the resulting new order-disorder balance may return the productivity to its former steady-state level as the herbicide pulse fades. Note that the effects of herbicide application upon the basic productivity disappear within two years in this model. Compare this two year lag with the 1.8 year lag observed in productivity model one. The recovery time is relatively fast considering the amount of land momentarily rendered unproductive.

A Minimodel of Disorder-Order Symbiosis Upon Structure As Stressed By A Viet Nam-Type War

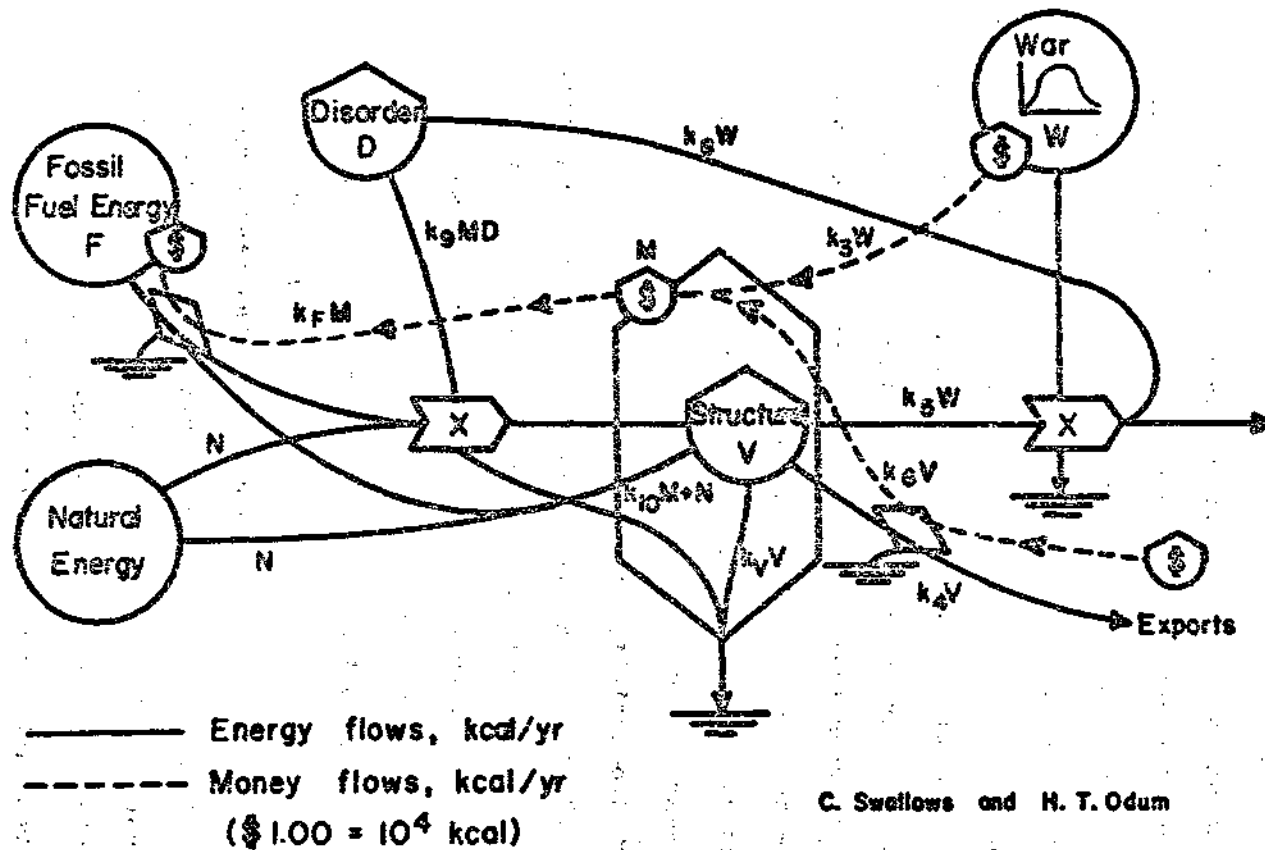

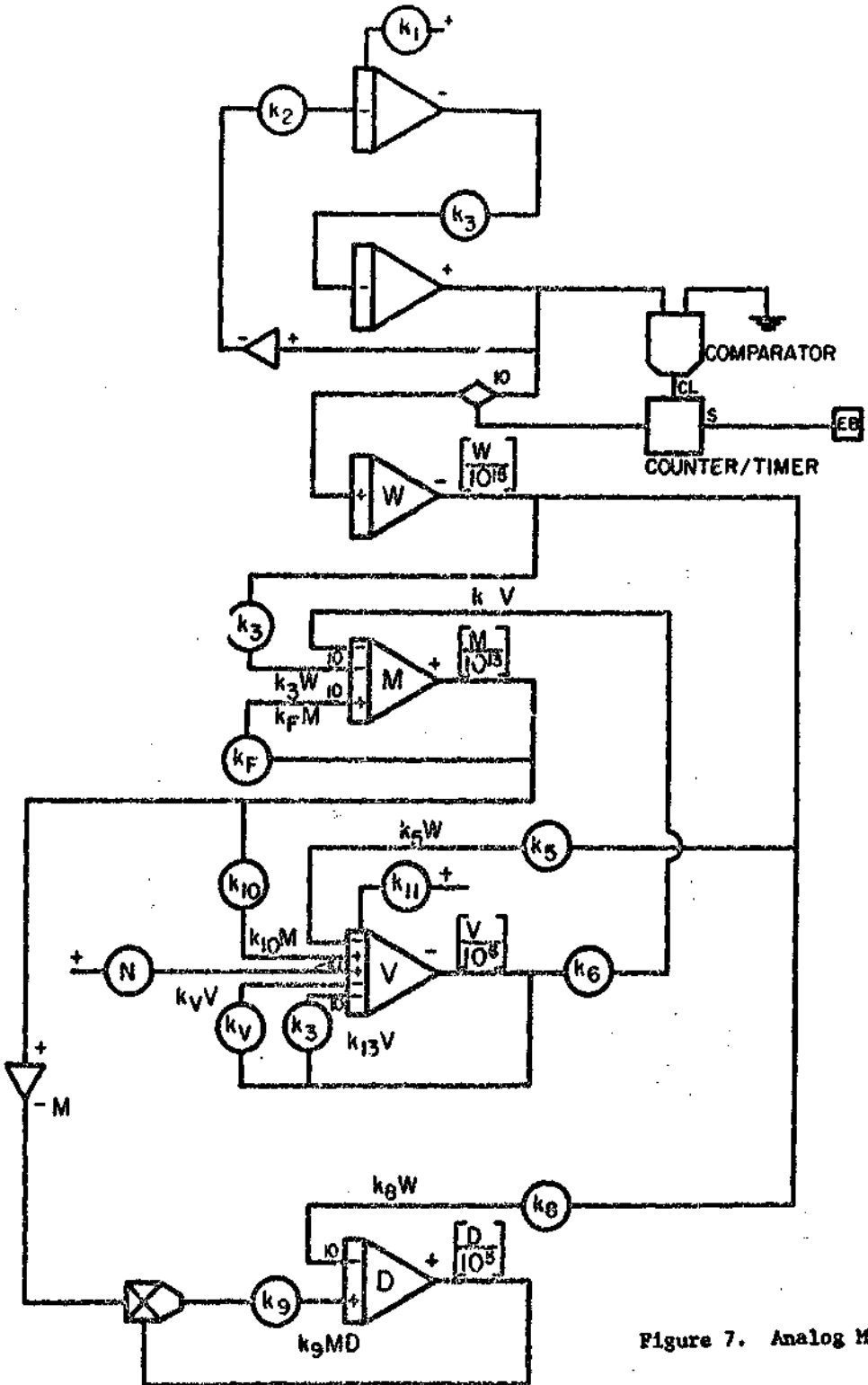

Figure 7. Analog Model.

Reproduced from
best available copy.

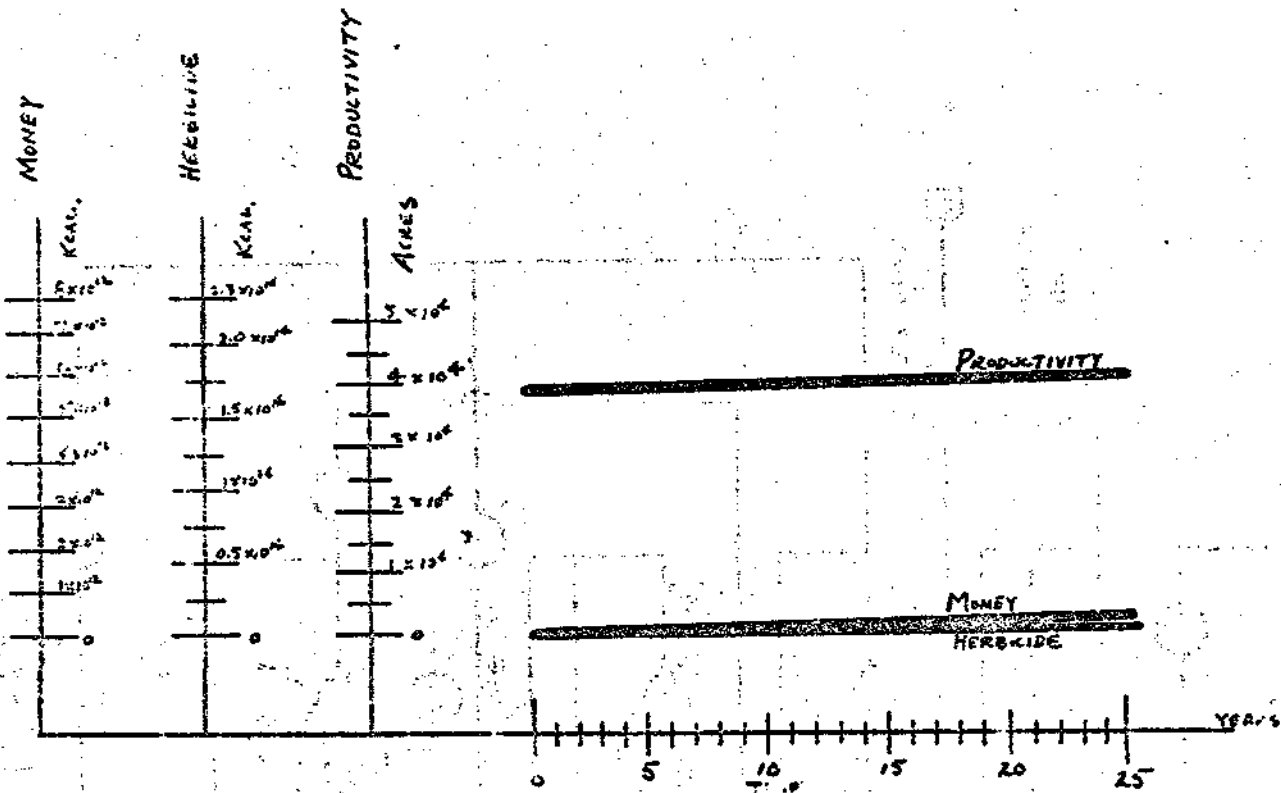

Figure 8. No War.

Reproduced from
best available copy.

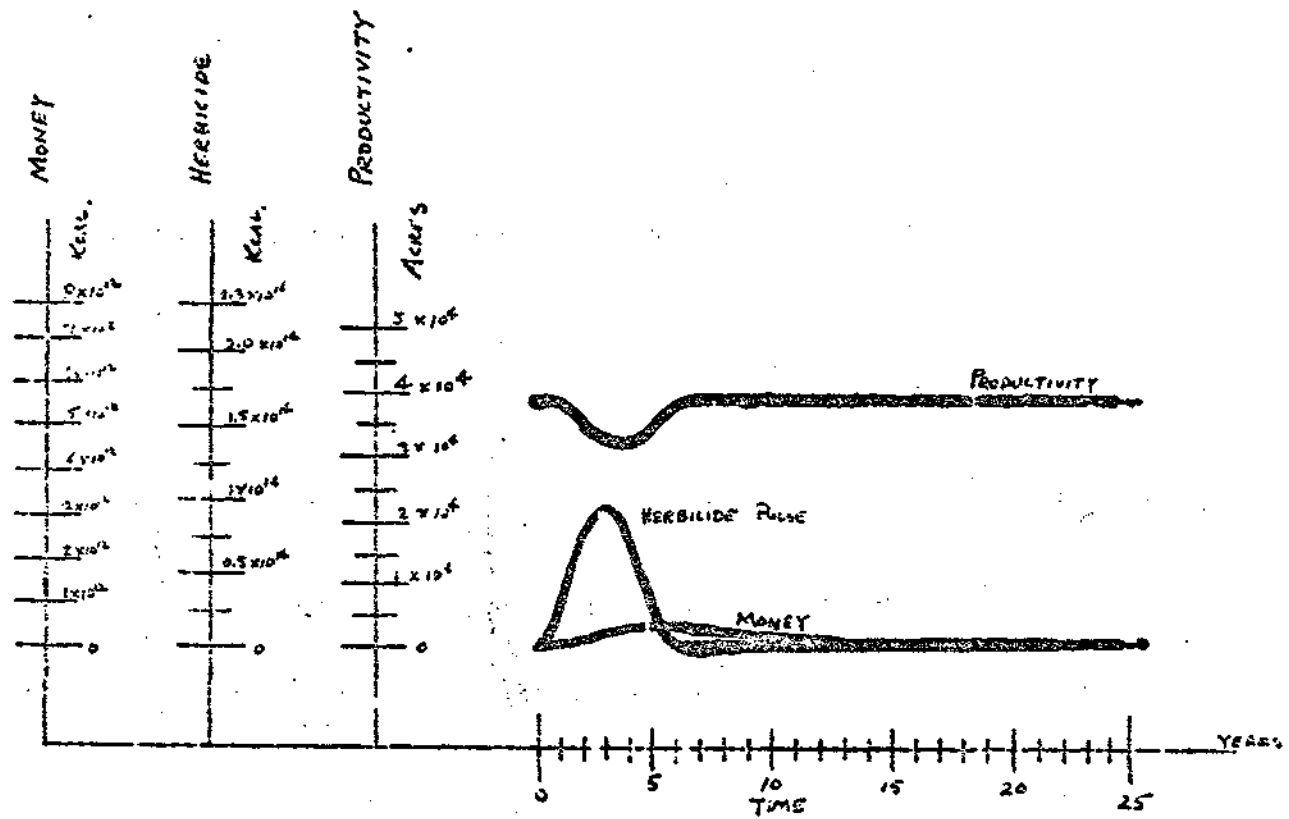

Figure 9. Five-year herbicide pulse.

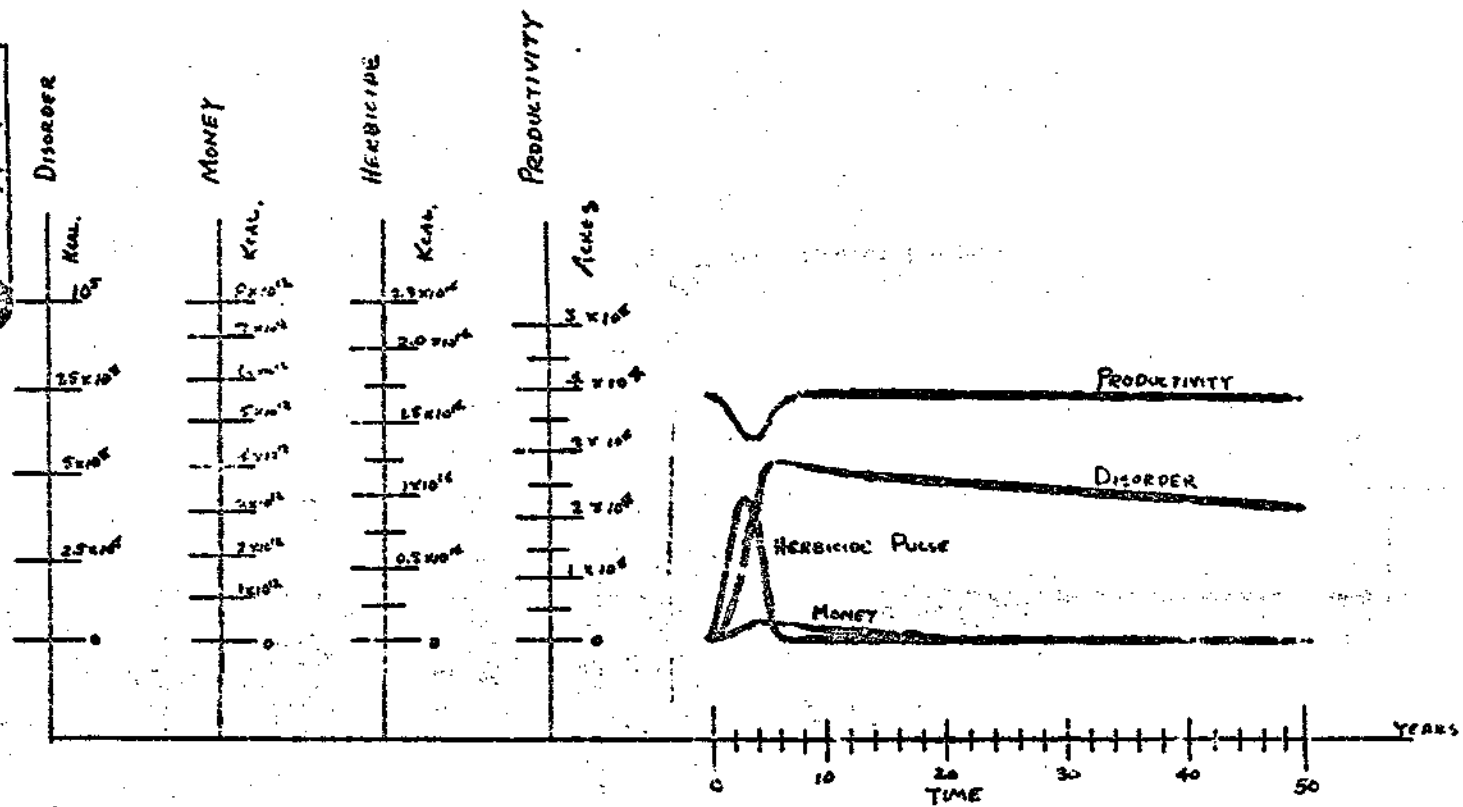

Figure 10. Five-year herbicide pulse and the resulting disorder.

In Fig. 11. the herbicide pulse width had been increased from five to ten years to determine the effects upon productivity, financial status, and disorder. The effect upon disorder is the only noticeable dissimilarity between Figures 10 and 11. Intuitively, disorder behaves as expected since it is created by stress and thus the longer the stress the greater the disorder. The recovery time time for productivity remains the same although the period in which it is stressed had been doubled.

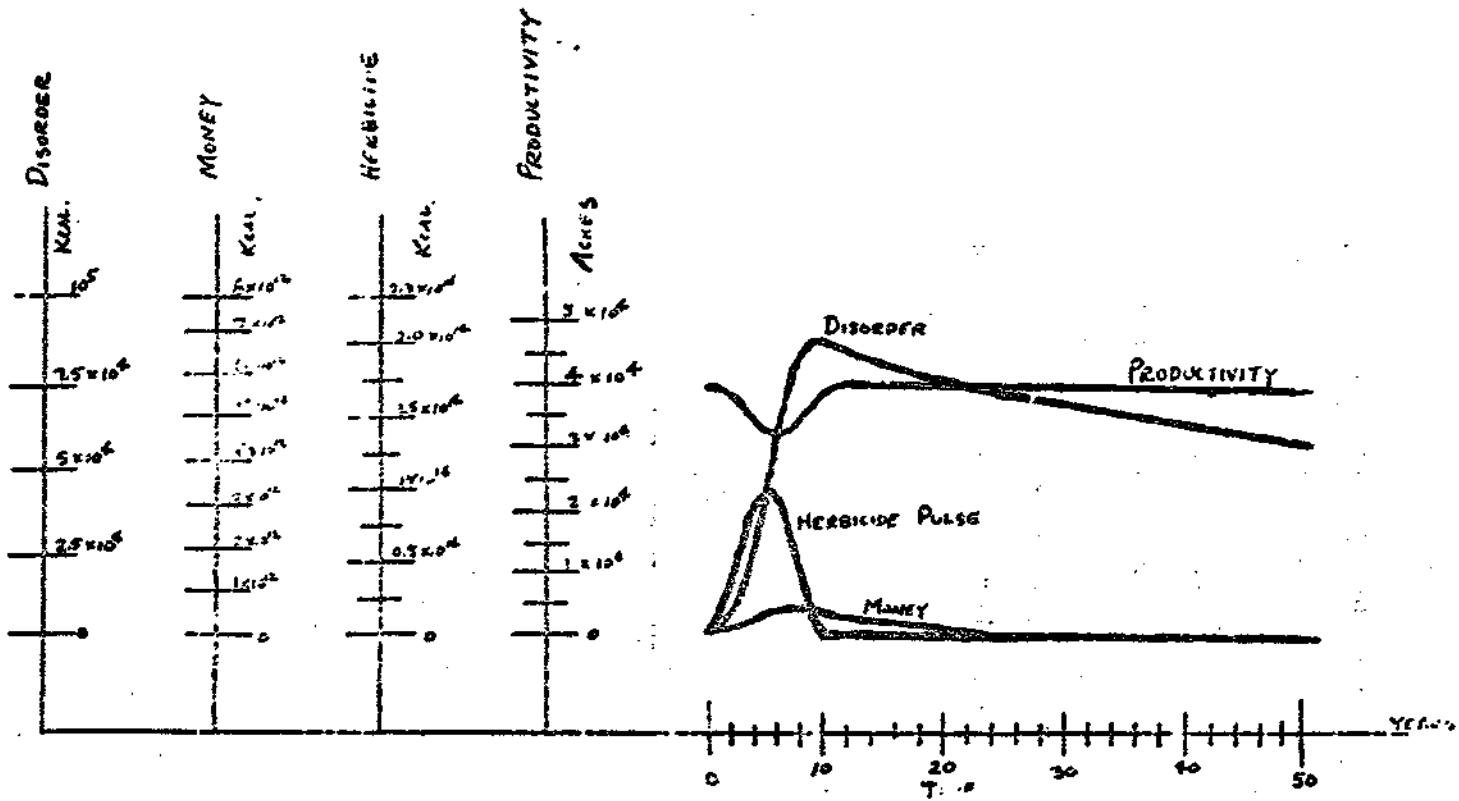

Figure 11. Ten-year herbicide pulse.

Differential Equations

$$\dot{W} = \text{Pulse Input}$$

$$\dot{M} = K_3W - K_7M + K_6V$$

$$\dot{V} = K_{10}M + N - K_4V - K_5W - K_{13}V$$

$$\dot{D} = K_8W - K_9MD$$

Scaling

The scaling in model two is essentially the same scaling which was done in model one except for the coefficients K_3 and K_8 . K_5 remained the same.

$$K_3W = 5 \times 10^{12} \text{ Koal}$$

$$K_3 = \frac{5 \times 10^{12}}{10^{15}} = 0.005$$

for the pot setting:

$$K_3 = \frac{(0.005)(10^{15})}{10^{13}} = 0.5 = 0.050(10)$$

$$K_8W = 10^4 \text{ Koal}$$

$$K_8 = \frac{2.7 \times 10^4}{10^{13}} = 2.7 \times 10^{-11}$$

for the pot setting:

$$K_8 = \frac{(2.7 \times 10^{-11})(10^{15})}{10^5} = 0.27 = 0.027(10)$$

Conclusions:

These simplified simulation models suggest that herbicide application greatly decreases the productivity in Vietnam but for a relatively short period of time. The resulting disordered lands interact with the natural energies and the subsidizing energies to form a relatively fast recovery time of two years. The recovery time is related to the natural turnover rate of once per year. The amount of agricultural and forest land rendered unproductive in the model during the period of herbicide application and the following recovery time reduced the productivity by 8.25% during the five years of herbicide application and the two years of recovery.

However, the financial assistance given by the United States generally increased in the same years as was the herbicide applied to agricultural and forest lands. The financial aid subsidized the export income. This would imply more capital per capita although the productivity of the country is low. Financially, the conflict in Vietnam stimulated the economy during these years and the energies purchased may have added to energy subsidies available to rural productivity as this model provides.

Observations in Vietnam indicate some validity of the models. The recovery time of two years observed in productivity model two is substantiated forests which were

bombed several years ago that have grown so dense that the bomb craters cannot be seen from the air. Also, agricultural lands which have been sprayed with herbicide or bombed several years ago are now producing crops. The increased influx of imports during this period of herbicide application substantiates the stimulation of the economy of the country. For example, a very popular import product was motorcycles.

9. Effect of Aerial Application of Herbicides On a Mangrove Community in Southwest Florida

Maurice G. Sell, Jr.

Introduction

As a sequel to the large scale spraying of herbicide in the Republic of Vietnam, Dr. Howard Teas of the University of Miami initiated a project to study the effects of aerial application of herbicide on a mangrove community in southwest Florida. He was assisted in the actual spraying by Jerry Kelly, one of his graduate students. Three sites were sprayed with Agent White on December 15, 1973, and three additional sites were sprayed on January 19, 1973. A study team from the University of Florida consisting of T. Ahlstrom, J. Browder, and M. Sell also participated in this program by obtaining measurements of parameters such as tree diameter, identification of tree species and whether they are alive or dead, fallen green and yellow leaves, number of live and dead seedlings, and number of snails.

By virtue of this spraying experiment a chronological account might then be made of the events that occur following spraying. How long does it take for the leaves to actually fall? What levels of herbicide are needed before defoliation is 100%? What species show the ability to rebound after spraying? What changes occur in those mangroves not completely killed but obviously stressed? By what means do the mangroves recolonize a sprayed area? Once the leaves have fallen due to spraying, how long does it take a tree to die if indeed it ever does? Hopefully, these and other questions will be answered by this experiment.

Methods

Some parameters studied at the Marco Island, Florida site included number of fallen green leaves, number of fallen yellow leaves, number of

crabholes, number of coffee shell snails, Melampus coffeus, number of red mangrove and black mangrove seedlings that were alive and also number that were dead. The above parameters were counted in five plots that each measured 20 meters by 40 meters or 800 m² in area. The five plots included a plot in which all the trees were harvested, a control plot and three plots that had been sprayed with Tordon 101^R. Fig. 1 is a map of the sprayed sites in southwest Florida. This is a herbicide quite similar to one of those used in South Vietnam. Herbicide dosages for the spray plots were 1 1/2 gallons per acre (estimated), 3 gallons per acre (estimated), and 2.2 gallons per acre (measured). In each plot counts of the parameters were made in each of 10 areas. These areas were 0.4 m² at the 5-week interval and 0.77 m² at the 20-week and 33-week intervals. Spraying of these plots was done on December 15, 1972 with a helicopter. Sampling dates were in January, May, and August, 1973, representing periods of 5, 20, and 33 weeks after the initial spraying. Sample areas in each plot were chosen at random to obtain representative counts for each parameter in a plot. Sample areas were different at each sample period so the data did have some scatter.

Growing tips of young red mangrove trees were also studied in each of the sprayed plots. Trees were anywhere from two to six feet in height, and the smaller ones were also required to have branches. These trees were then observed closely to determine if the growing tips were alive or seemed to have been killed by the herbicide. Counts were then made of trees with at least one growing tip and also of trees that did not appear to have any live growing tips. In many instances the growing tip may have been killed initially and new growth was emerging beneath the old tip or a side shoot. This was considered a live growing tip.

The three sprayed plots mentioned earlier were studied in this manner at intervals of 20 and 33 weeks after spraying. Three other plots were sprayed five weeks after the initial spraying at dosages of 4.25 gallons per acre (measured), 6 gallons per acre (estimated) and 2.4 gallons per acre (measured). For these plots the growing tips were counted at intervals of 15 and 28 weeks after spraying.

In each of the sites sprayed December 15, 1972, (10 meters x 20 meters) an area equal to 25% of the area of each site was mapped and the diameter of each tree was measured. Live and dead trees were also discerned. This mapping and measuring was also done for one of the control sites but for a larger area (20 meters x 20 meters). Mapping was done with an allodade and a stadia

Legend to Figure 1

C-1	Control area
C-2	Control area
SP-1	Spray plot 1 (1½ gallons per acre estimated)
SP-2	Spray plot 2 (3 gallons per acre estimated)
SP-3	Spray plot 3 (2.2 gallons per acre measured)
SP-4	Spray plot 4 (4.25 gallons per acre measured)
SP-5	Spray plot 5 (6 gallons per acre estimated)
SP-6	Spray plot 6 (2.4 gallons per acre measured)

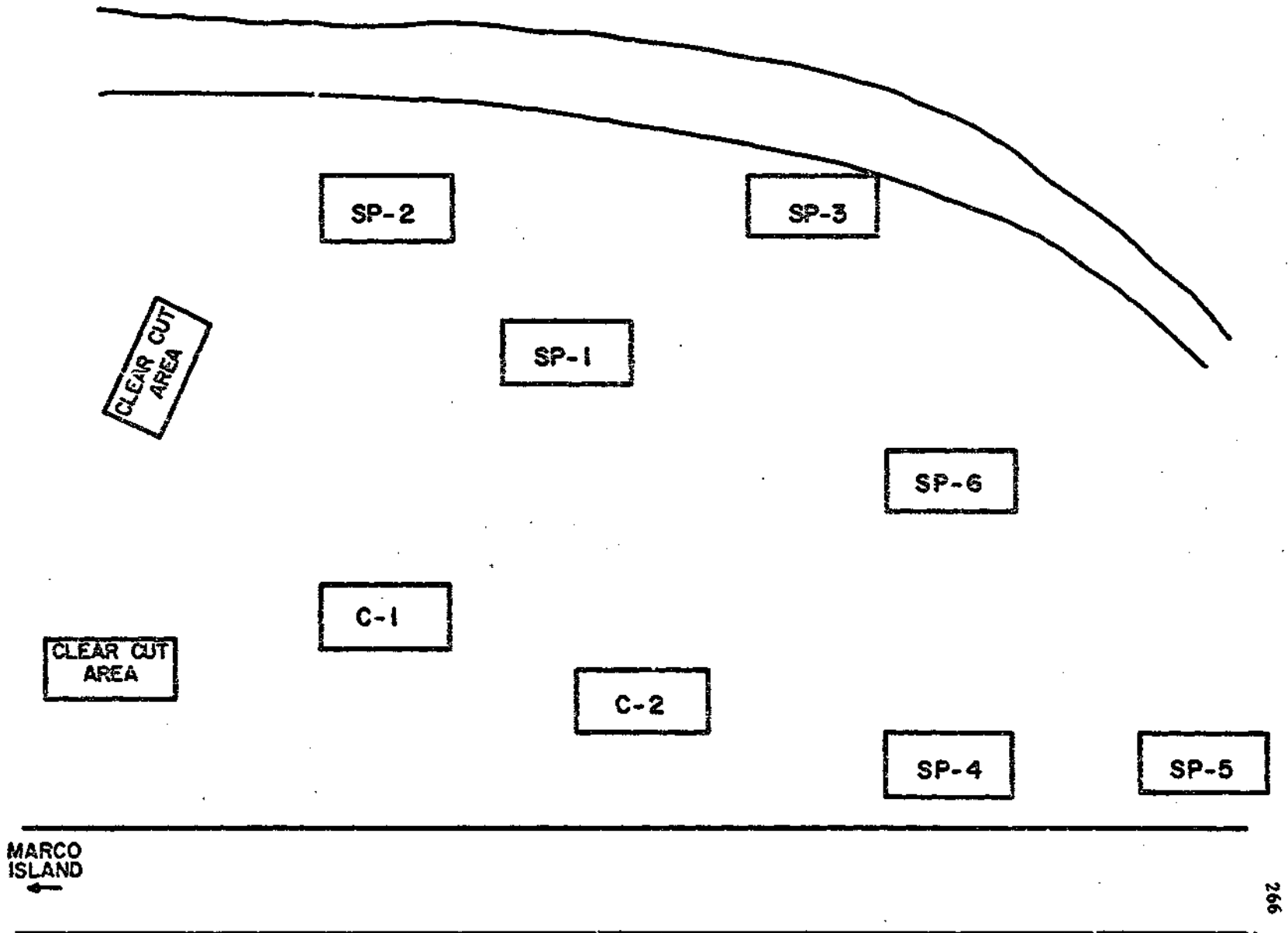

Figure 1. Map of Sprayed Areas and Control Areas.

rod (used to get distance and direction).

Results

Density of Green Leaves

The number of green leaves was not determined in the clear cut plot at five weeks after cutting and no green leaves were observed at 20 and 33 weeks. The control plot had 0.5, 0.6, and 0 green leaves per m^2 at 5, 20 and 33 weeks. The plot sprayed with an estimated dosage of 1 1/2 gallons per acre had 31.4, 0.1 and 0.1 green leaves per m^2 at 5, 20 and 33 weeks. The plot sprayed with an estimated dosage of 3 gallons per acre had 29.0, 0.8 and 0.1 green leaves per m^2 at 5, 20 and 33 weeks. The plot sprayed with an actual dosage of 2.2 gallons per acre had 75.8 green leaves per m^2 at 5 weeks and no green leaves were observed at 20 and 33 weeks.

Density of Yellow Leaves

The number of yellow leaves per m^2 was not determined in the clearcut plot at 5 weeks after cutting. The clearcut plot had 0.4 and 0 yellow leaves per m^2 after 20 and 33 weeks. The control plot had 20.2, 1.2 and 2.7 yellow leaves per m^2 at 5, 20 and 33 weeks. The plot sprayed with an estimated dosage of 1 1/2 gallons per acre had 104, 0.3 and 1.8 yellow leaves per m^2 at 5, 20 and 33 weeks. The plot sprayed with an estimated dosage of 3 gallons per acre had 141, 0.5, and 0.1 yellow leaves per m^2 at 5, 20 and 33 weeks. The plot sprayed with an actual dosage of 2.2 gallons per acre had 304, 0.4 and 1.0 yellow leaves per m^2 at 5, 20 and 33 weeks. The results for both green leaves and yellow leaves are given in Table 1.

Density of Crabholes

The number of crabholes per m^2 was not obtained at the sampling period 5 weeks after spraying for any of the plots. The clear cut plot had 14.9 crabholes per m^2 at 20 and 33 weeks. The control plot had 14.2 and 15.5 crabholes per m^2 at 20 and 33 weeks, respectively. The plot sprayed with an estimated dosage of 1 1/2 gallons per acre had 6.8 and 13.1 crabholes per m^2 at 20 and 33 weeks. The plot sprayed with an estimated dosage of 3 gallons per acre had 13.2 and 10.7 crabholes per m^2 at 20 and 33 weeks. The plot sprayed with an actual dosage of 2.2 gallons per acre had 12.5 and 14.0

TABLE 1

Density* of green leaves and yellow leaves per m^2 following aerial application of Tordon 101^d

Weeks after spraying	Number of green leaves per m^2			Number of yellow leaves per m^2		
	5	20	33	5	20	33
Clearcut plot	---	0	0	---	0.4	0
Control plot	0.5	0.6	0	20.2	1.2	2.7
Spray plots						
1½ gallons per acre (estimate)	31.4	0.1	0.1	104	0.3	1.8
3 gallons per acre (estimate)	29.0	0.8	0.1	141	0.5	0.1
2.2 gallons per acre (measured)	75.8	0	0	304	0.4	1.0

* Densities in each plot are based on an average of 10 sampling areas of $0.4 m^2$ each at 5 weeks and of areas of $0.77 m^2$ each at 20 and 33 weeks.

crabholes per m^2 at 20 and 33 weeks. These results are given in Table 2.

Density of snails

The number of live snails were not counted at the 5-week interval in the clear cut plot but at 20 and 33 weeks the clear cut had 5.1 and 13.8 live snails per m^2 , respectively. The control plot had 38.1, 66.0, and 38.4 snails per m^2 at 5, 20, and 33 weeks, respectively. The plot sprayed with an estimated dosage of 1 1/2 gallons per acre had 74.7, 68.2, and 54.8 snails per m^2 at 5, 20 and 33 weeks, respectively. The plot sprayed with an estimated dosage of 3 gallons per acre had 45.5, 56.6 and 3.2 snails per m^2 at 5, 20, and 33 weeks. The plot sprayed with an actual dosage of 2.2 gallons per acre had 77.7, 15.7 and 15.5 snails per m^2 at 5, 20, and 33 weeks.

Density of Live Seedlings

The clear cut plot had 0.6 and 0.8 red mangrove seedlings per m^2 at 20 and 33 weeks. The number of black mangrove seedlings was 3.3 and 2.3 m^2 at 20 and 33 weeks, respectively. The control plot had no red mangrove seedlings at 5 and 20 weeks but had 0.2 per m^2 at 33 weeks. The number of black mangrove seedlings in the clearcut plot was 0.8, 0.6 and 0.3 at 5, 20 and 33 weeks. The plot sprayed with an estimated dosage of 1 1/2 gallons per acre had 2.0, 0.2 and 0.5 red mangrove seedlings and 3.7, 2.1 and 2.2 black mangrove seedlings at 5, 20 and 33 weeks, respectively. The plot sprayed with an estimated dosage of 3 gallons per acre had 2.0, 0.4, and 1.7 red mangrove seedlings per m^2 and 7.3, 4.9 and 2.9 black mangrove seedlings per m^2 at 5, 20 and 33 weeks, respectively. The plot sprayed with an actual dosage of 2.2 gallons per acre had 2.8, 2.5 and 0.5 red mangrove seedlings per m^2 and 4.4, 1.8 and 3.2 black mangrove seedlings per m^2 at 5, 20 and 33 weeks.

Density of Dead Seedlings

No dead seedlings were observed at any time in the clear cut plot and also the control plot. The plot sprayed with an estimated 1 1/2 gallons per acre had 0.6, 0, and 0.4 red mangrove seedlings per m^2 and 2.0, 0.5, and 0.5 black mangrove seedlings per m^2 at 5, 20 and 33 weeks. The plot sprayed with an estimated 3 gallons per acre had 0.3, 1.1, and 0.5 red mangrove seedlings per m^2 at 5, 20 and 33 weeks. The plot sprayed with an actual dosage of 2.2 gallons per acre had 0, 1.8, and 0.3 red mangrove seedlings

TABLE 2

Density* OF crabholes and of the coffee shell snail Malampus coffeus following aerial application of Torion 131⁴

Weeks after spraying	Number of crabholes per m ²			Number of snails per m ²		
	5	20	33	5	20	33
Clearcut plot	---	14.9	14.9	---	5.1	13.8
Control plot	---	14.2	15.5	38.1	66.0	38.4
Spray plots						
1½ gallons per acre (estimate)	---	6.8	13.1	74.7	68.2	54.8
3 gallons per acre (estimate)	---	13.2	10.7	45.5	56.6	3.2
2.2 gallons per acre (measured)	---	12.5	14.0	77.7	15.7	15.5

* Densities in each plot are based on an average of 10 sampling areas of 0.4 m² each at 5 weeks and of areas of 0.77 m² each at 20 and 33 weeks.

TABLE 3

Live and dead seedling densities* following
aerial application of Tordon 101^H

Weeks after spraying	Live seedling density						Live seedling density					
	<u>Rhizophora mangle</u>			<u>Avicennia nitida</u>			<u>Rhizophora mangle</u>			<u>Avicennia nitida</u>		
<u>spraying</u>	<u>5</u>	<u>20</u>	<u>33</u>	<u>5</u>	<u>20</u>	<u>33</u>	<u>5</u>	<u>20</u>	<u>33</u>	<u>5</u>	<u>20</u>	<u>33</u>
Clearcut plot	---	0.6	0.8	---	3.3	2.3	---	0	0	---	0	0
Control plot	0	0	0.2	0.8	0.6	0.3	0	0	0	0	0	0
Spray plots												
1 1/2 gallons per acre(estimated)	2.0	0.2	0.5	3.7	2.1	2.2	0.6	0	0.4	2.0	0.5	0.5
3 gallons per acre(estimated)	2.0	0.4	1.7	7.3	4.9	2.9	0.3	1.1	0.5	2.8	1.7	0.4
2.2 gallons per acre(measured)	2.8	2.5	0.5	4.4	1.8	3.2	0	1.8	0.3	4.7	0	0

* Densities in each plot are based on an average of 10 sampling areas of 0.4 m² each at 5 weeks and of areas of 0.77 m² each at 20 and 33 weeks.

Numbers are based on a square meter

per m^2 and 4.7, 0, and 0 black mangrove seedlings per m^2 at 5, 20 and 33 weeks.

Study of Red Mangrove Growing Tips

The plot sprayed with an estimated dosage of 1 1/2 gallons per acre had 50 young red mangrove trees with at least one live growing tip out of 84 trees that were counted. The rest of the 84 trees had no live growing tips. The count was made at 33 weeks. The plot sprayed with an estimated 3 gallons per acre had 45 trees with at least one live growing tip out of 109 trees that were counted at 20 weeks and 56 out of 74 counted had live growing tips at 33 weeks. The plot sprayed with an actual dosage of 2.2 gallons per acre had 43 trees with at least one live growing tip out of 107 counted at 20 weeks and 92 out of 158 counted had live growing tips at 33 weeks. The plot sprayed with an actual dosage of 4.25 gallons per acre had 144 trees with at least one live growing tip out of 236 trees that were counted at 15 weeks and 134 out of 177 had live growing tips at 28 weeks. The plot sprayed with an estimated dosage of 6 gallons per acre had 59 trees with at least one growing tip alive out of 195 counted at 15 weeks. The plot sprayed with an actual dosage of 2.4 gallons per acre had 53 trees with at least one live growing tip out of 224 trees counted at 15 weeks. No counts were made for these last two plots at 28 weeks.

Figs. 2 to 5 are maps of each of the first spray sites and a control site showing the mapped areas and the identification of the tree species along with the diameter of each tree. The data on the maps are summarized in Table 5.

Discussion

Table 1 shows that the effect of the herbicide application is to cause early abscission of leaves while they are still green. The highest number of green and yellow leaves lying on a square meter of forest floor occurred in the plot sprayed with an actual dosage that averaged 2.2 gallons per acre over the canopy. One reason for this may be that the actual dosages received by the other two plots may have been much less than the levels desired. Another possibility is that the other two plots have a greater number of black mangroves than red mangroves. The plot with an estimated dosage of 1 1/2 gallons per acre was 76% black mangrove (Fig. 3) and the plot with an estimated dosage of 3 gallons per acre was 60% black mangrove (Fig. 4). The plot with 2.2

TABLE 4

Effect of aerial application of Torion 101ⁿ
on the growing tips of dhizophora seedlings

Weeks after spraying	Number of seedlings with at least one <u>live growing tip</u>				Number of seedlings with no live growing <u>tips</u>				ratio of live to <u>dead</u>			
	15	20	28	33	15	20	28	33	15	20	28	33
Spray plots												
1½ gallons per acre(estimated)		---		50		---		34		---		1.47
3 gallons per acre(estimated)		45		56		64		18		0.70		3.11
2.2 gallons per acre(measured)		43		92		64		66		0.67		1.39
4.25 gallons per acre(measured)	144		134		92		43		1.56		3.12	
6 gallons per acre(estimated)	59		---		136		---		0.43		---	
2.4 gallons per acre(measured)	53		---		171		---		0.31		---	

Legend to Figures 2,3,4,5

- Live Rhizophora mangle
- Dead " "
- ◻ Live Avicennia nitida
- ◼ Dead " "
- ▲ Live Laguncularia racemosa
- ▲ Dead " "

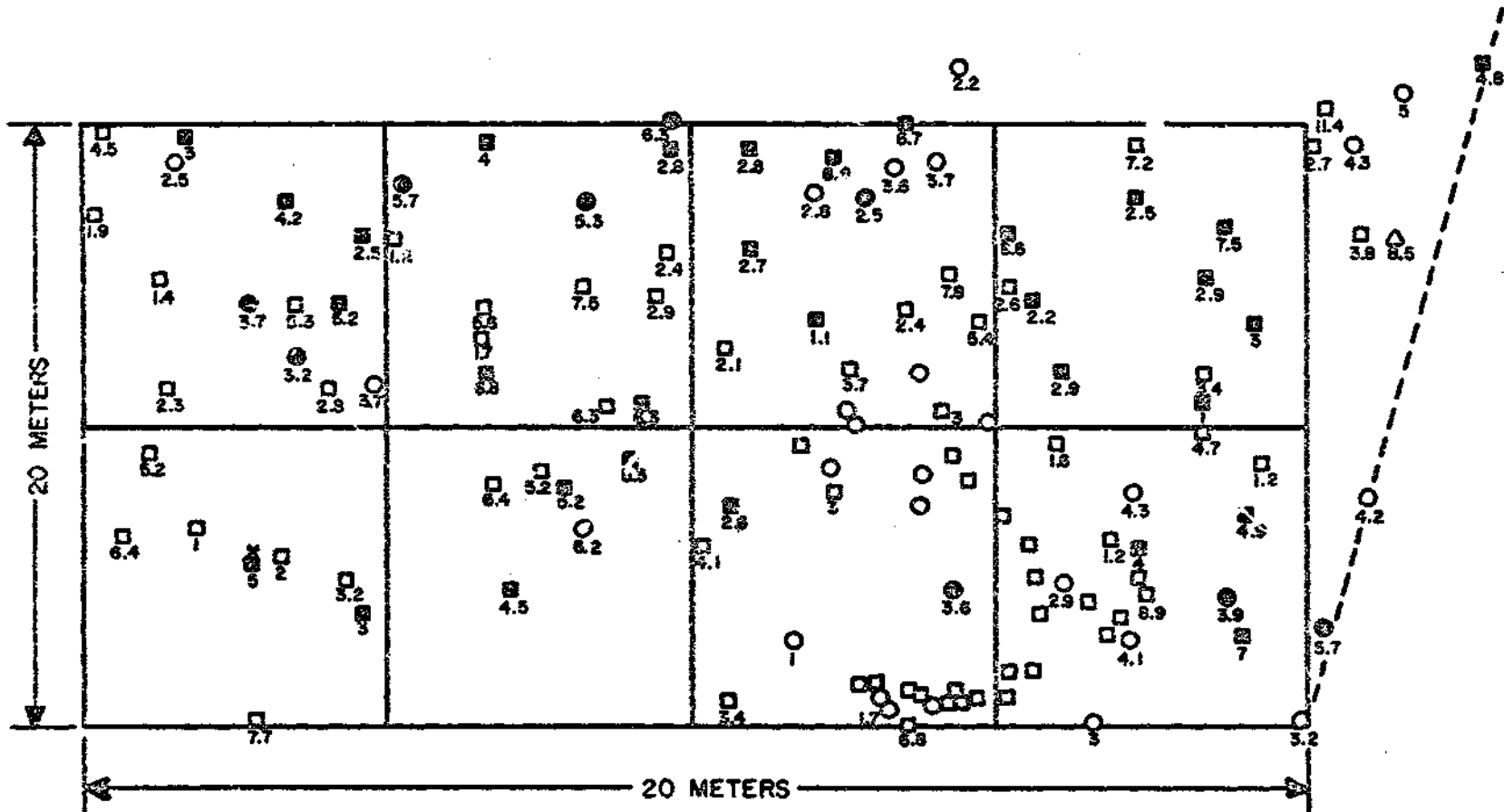

Figure 2. Map of spray plot No. 1, showing tree locations and diameters.

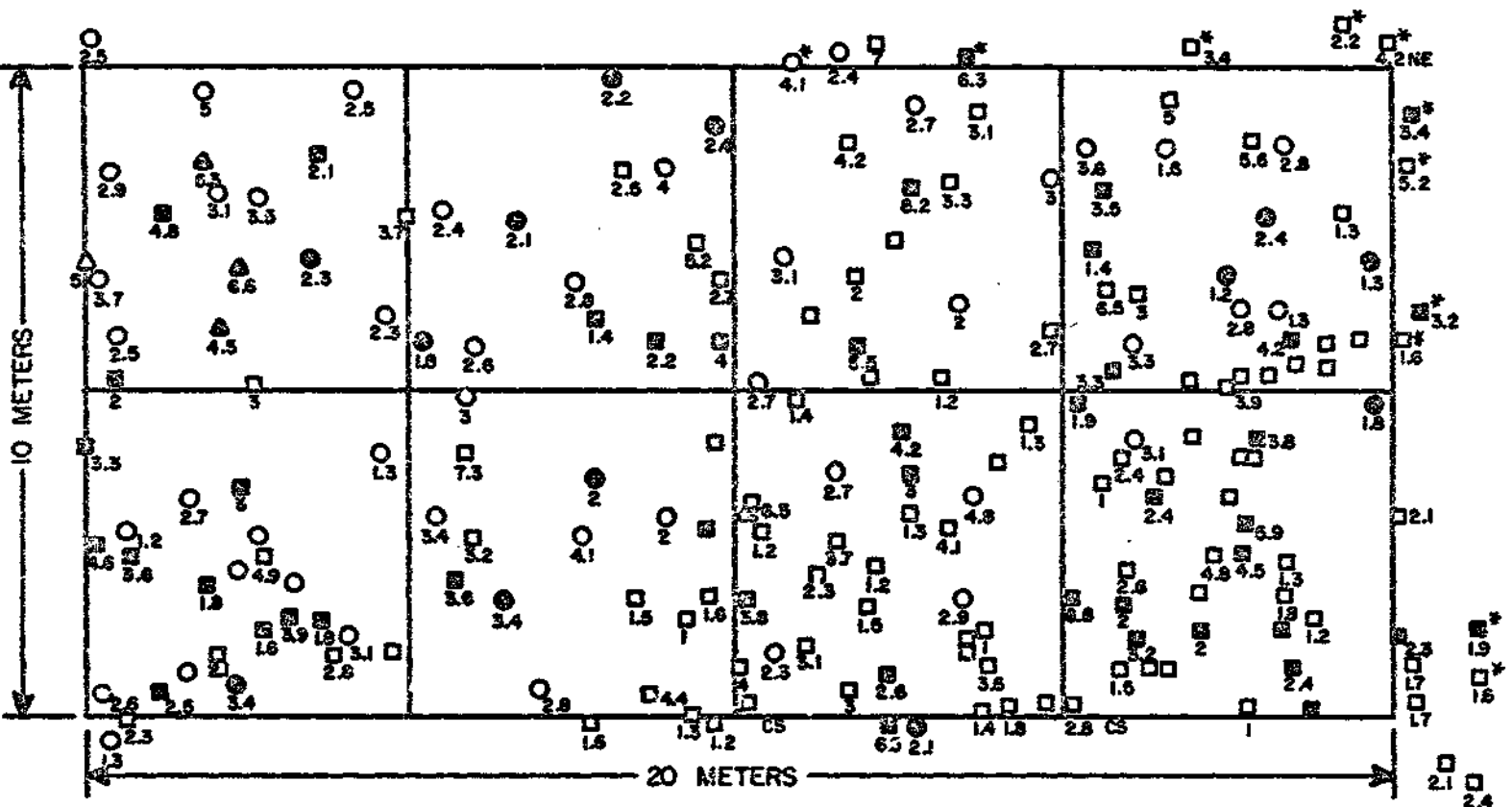

Figure 3. Map of spray plot No. 2 showing tree locations and diameters.

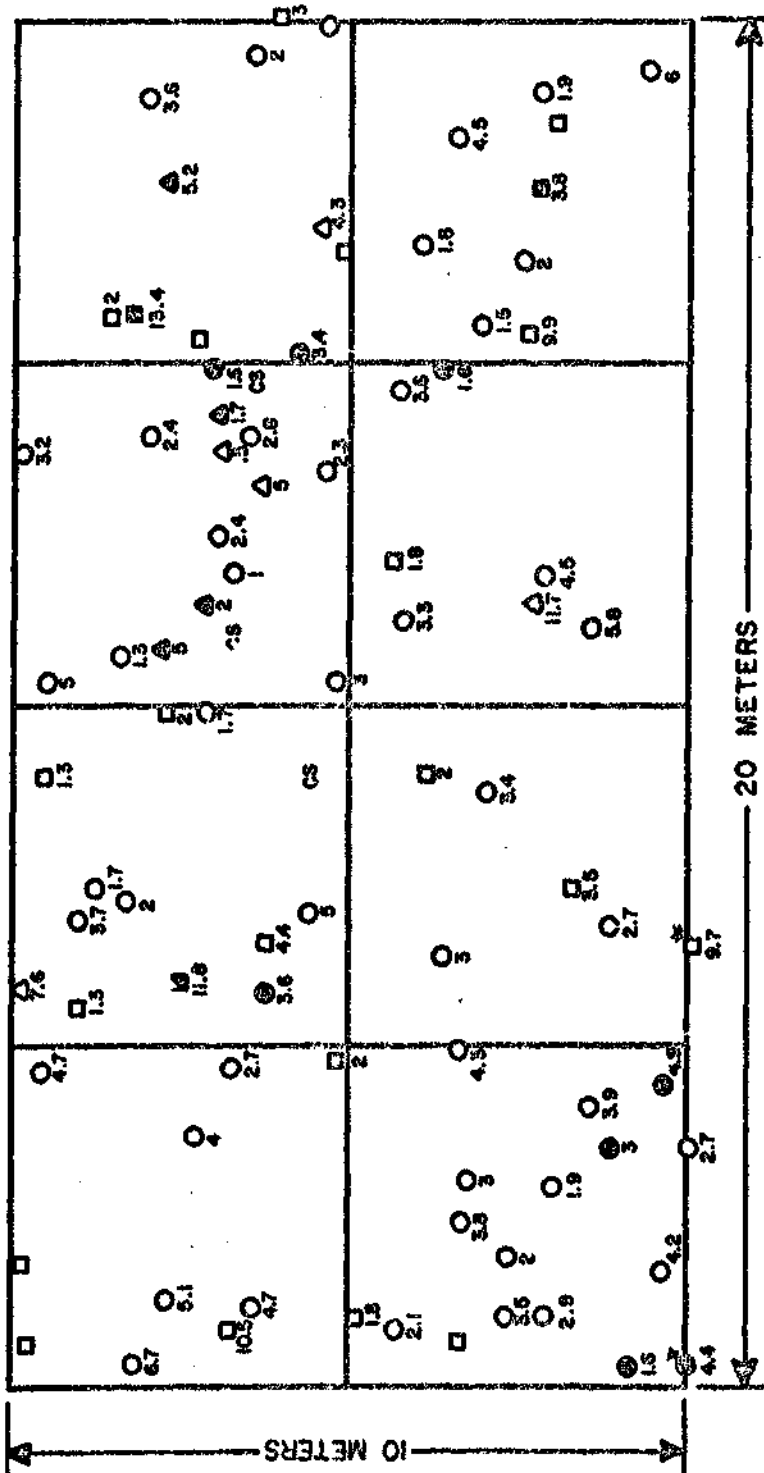

Figure 4. Map of spray plot No. 3 showing tree locations and diameters.

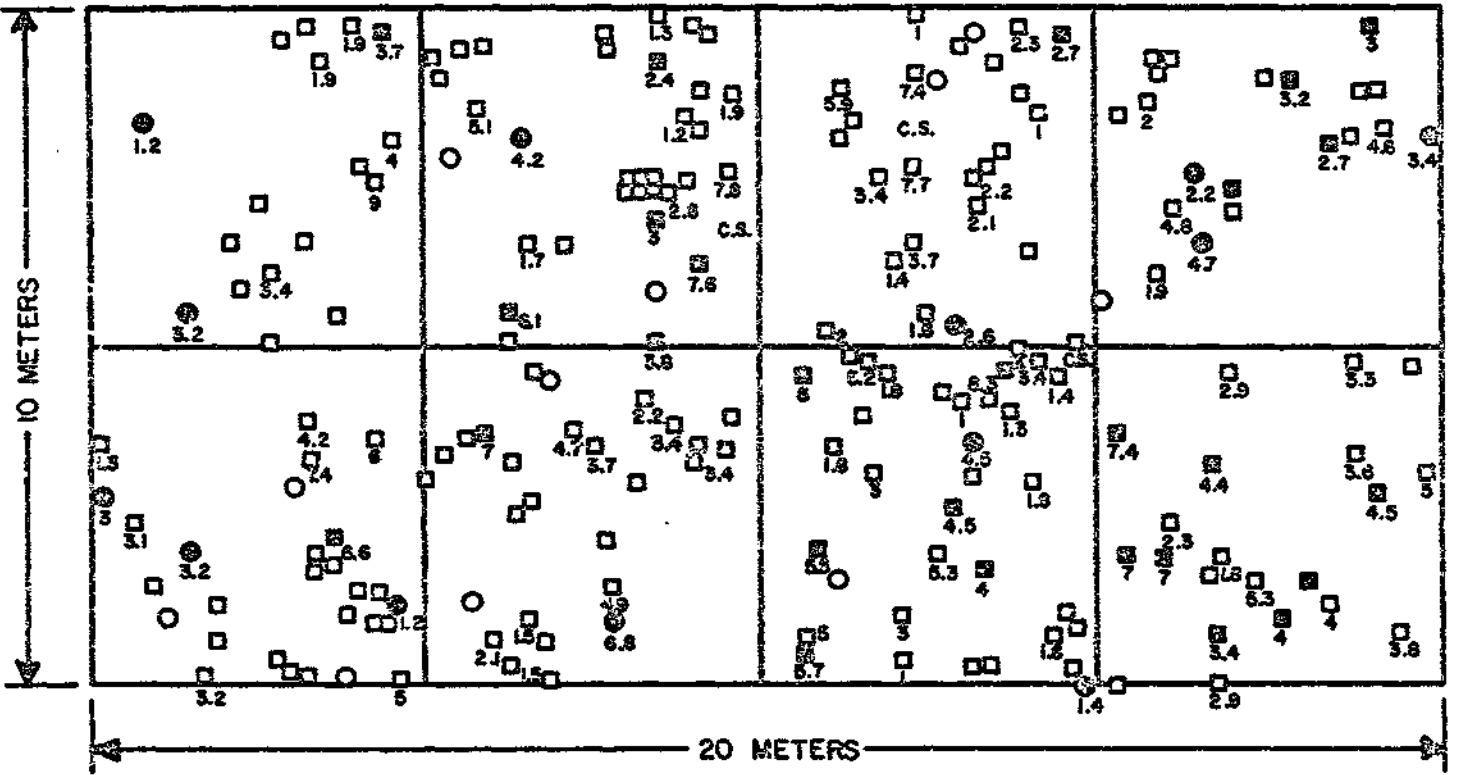

Figure 5. Map of control plot showing tree locations and diameters.

Table 5

Composition of Mangrove Forest at Herbicide Experiment Site
on Marco Island Prior to Spraying

Measurement	Control Plot	Spray Plots		
	1	1	2	3
Number <u>Rhizophora mangle</u>				
Live (diameter \leq 1")	0	13	41	45
Dead	19	9	13	9
Number <u>Avicennia nitida</u>				
Live (diameter \leq 1")	150	41	63	14
Dead	50	31	43	3
Number <u>Laguncularia racemosa</u>				
Live (diameter \leq 1")	0	0	1	5
Dead	0	0	3	4
Percent dead to total standing trees	31.7	42.5	64	20

gallons per acre was only 22% black mangrove (Fig. 5). In this study the first trees to be completely defoliated were the white mangroves (Laguncularia racemosa). Red mangroves were also very susceptible to herbicide but loss of leaves took longer. The least susceptible were the black mangroves which helps to explain the lower leaf counts of the plots with the estimated dosages.

By the time 20 weeks had elapsed the number of fallen green and yellow leaves on the ground had decreased to levels equal to or slightly lower than the control plot levels. The 2.2 gallons per acre plot was defoliated to such an extent that no green leaves were observed on the ground at 20 or 33 weeks after spraying. The low values for all of the plots at 20 weeks indicate that defoliation had progressed as far as it was going to by that time.

One of the fauna occurring in significant numbers in every plot was the coffee-shell snail, Melampus coffeus. This animal occurs on the forest floor, on the prop roots, the pneumatophores and the mangrove trees and is a grazer of detritus and algae in the mangrove community. Although a count was not made before clear cutting, the counts made after the fact were very low compared to the control plot. This indicates that the snail has left the clear cut area for some reason. The same phenomenon was observed in the plots sprayed with an actual dosage of 2.2 gallons per acre and an estimated dosage of 3 gallons per acre. The plot sprayed with an estimated 1 1/2 gallons per acre has also shown a decline in the number of snails with time after spraying but not as noticeable as the other two plots. The reason for this decline in snail numbers may be due to the presence of increasing amounts of solar radiation reaching the forest floor. This would have the effect of heating the water and the soil to temperatures that are too high for the snail to tolerate. The question that arises here is whether the snails leave or do they die.

Another animal that is commonly found in mangroves is the fiddler crab which is represented by many species in the genus Uca. Fiddler crabs dig burrows and so to obtain a rough estimate of the numbers of fiddler crabs the number of crabholes per m² was counted in each plot. Table 2 shows that there is very little difference in the number of crabholes as the time after spraying increases. The validity of using this technique as an indicator of crabs present is questionable. Obviously, the presence of a hole is not a positive indicator that the crab is still there. However, based on the available data it does not appear that elimination of the canopy significantly effects the fiddler crab population in the sprayed and clear cut plots.

Table 3 shows that the overall effect of spraying was to decrease the number of live seedlings as the time after spraying increased. Another cause of seedling death was probably from the many investigators walking in the plots. Although the number of live red and black mangrove seedlings decreased, the number of dead red and black mangrove seedlings did not correspondingly increase very much. The discrepancy here may be due to the sampling technique. Different areas were sampled at each sampling period after spraying and there may be some unintentional bias entering in here. Dead red mangrove seedlings do appear to increase in two of the three sprayed plots and remain reasonably constant in the other plot.

Because no definite conclusion can be made as to why live seedlings are decreasing and dead black mangrove seedlings are not correspondingly increasing but are instead decreasing, another means of measurement was devised to find out if the herbicide was influencing seedlings. The number of seedlings with at least one live growing tip were compared to those with no live growing tips. Table 4 shows a column indicating the ratio of seedlings with at least one growing tip to those with no growing tips. In every spray plot where two time periods have been observed this ratio has increased. The significance of this is that those seedlings with no growing tips are beginning to recover from the spraying. The dosage in the understory where these seedlings are found was found to be about 0.5 gallons per acre when measured. The effect of the herbicide in many instances was to kill the growing tips but not to defoliate the older leaves. Apparently this has enabled the young mangrove trees to recover. An effect of the herbicide is noticeable by the occurrence of the new growth coming out a side shoot rather than its normal position which was killed by the herbicide.

10. Section in Part A Based on Fla-NAS Contract

The following is the section prepared for Part A of the report to Congress and Committee approved July, 12, 1973. It summarizes some findings of the contract.

VIII. EFFECTS OF HERBICIDES ON ECOSYSTEMS

The NAS Committee was asked to: "Investigate the ecological and physiological effects of the defoliation and crop destruction programs in SVN." Results and conclusions of greater or lesser degree of confidence, dependent on a variety of factors, flow from such a study. One caution in interpreting such a study is to avoid the common tendency to assume that all changes are effects only of the impact of the agents (herbicides) being studied. Such an interpretation would be inappropriate in this case since it is known that many changes were taking place independent of herbicide sprays in the period since 1962.

Another common error is failing to consider secondary interactions, feedback actions and time delays. To recognize and evaluate such complexities while visualizing the relationships of man and nature in overview, systems diagrams are helpful. For example, a simplified overview of Vietnam's energy basis is drawn in Figure 1. This diagram shows the action of war and herbicide accelerating recyclic reuse of disordered lands, building materials from damaged towns, displaced populations, and nutrient chemical elements. These are all parts out of which new order is generated when they are fed back to stimulate regrowth, interacting with energy sources available for reconstruction. Quantitative evaluation of the rates gives perspectives on what is important, and computer calculations are used to show cumulative effects.

The defoliation and crop destruction programs in SVN had undeniable ecological, physiological, social and economic impacts. Similar effects from different causes are present in many areas of the world including Vietnam. In Vietnam, as a result of the war, there were massive social and economic changes associated with the transformation of the economy and movement of

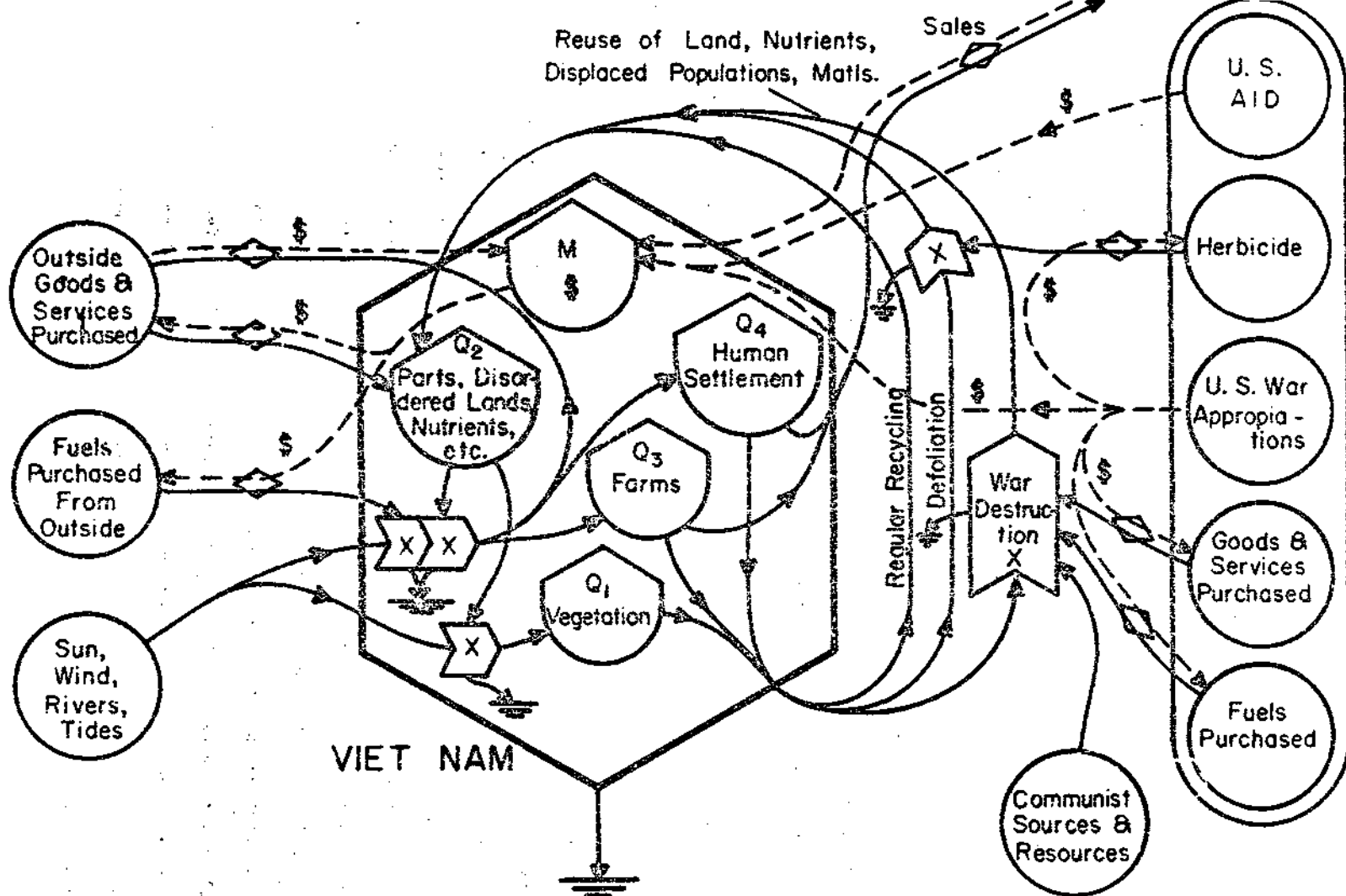

Figure 1. Overall view of pathways of energy and money in Viet Nam. Circles are energy sources with causal action from outside. Tank symbols are storages within Viet Nam. Pointed blocks marked X are multiplier control actions of one energy source on another. Money flows are dashed and flow in opposite direction to the energies, goods and services they purchase. A set of mathematical equations goes with this diagram.

peoples; there were vast areas exposed to destructive forces of bombing and shelling. The impacts of defoliation and crop destruction must be considered and interpreted within this context. The relative magnitudes of component sources of impacts must be considered in order to maintain an overall perspective.

Large scale systems of man and nature such as inland forest, mangrove forest, agricultural countryside, and urban areas undergo continuous processes of construction, self maintenance, and reconstruction that tend to increase or replace the amount of organized structure in the form of, for example, human settlement, trees, soil, or wildlife. At the same time there are natural tendencies for structures to deteriorate with time. There are also special disruptive processes such as earthquakes, hurricanes, and war, including, for example, the defoliation and crop destruction programs.

Viewing Vietnam's processes as a whole assists in gaining insight into the relative magnitude of any one disruptive process. One way of doing this is to combine understanding of relationships in simplified systems diagrams like that in Fig. 1. Simplified summarizations are sometimes called models. Diagramming and quantitative evaluating of the pathways of causative action are also a means of recognizing and presenting mathematical relationships, which can then be combined in computer calculations to make predictions as to the effect of assumptions used in simplifying the diagrams and the data used in writing the mathematical equations. Along with human intuition and judgment the "systems modelling methods" have been demonstrated as a useful tool for objective forecasting of the relations of parts of the environment to show consequences in time of their interactions. In our study several models and computer simulations were made including the conditions of temperature affecting mangroves in bare mud microhabitat (See Part B), the flows of nitrogen and phosphorus affecting the reforestation in the Rung Sat estuary (Fig. 2), the effect of seedling

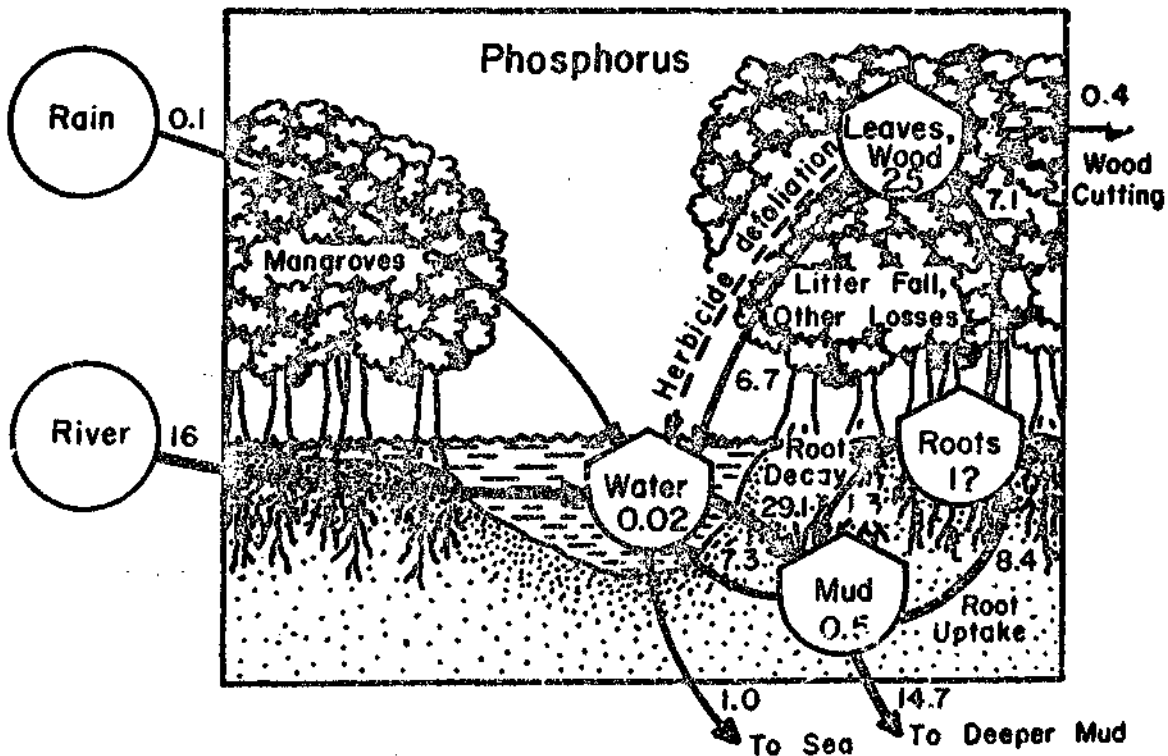
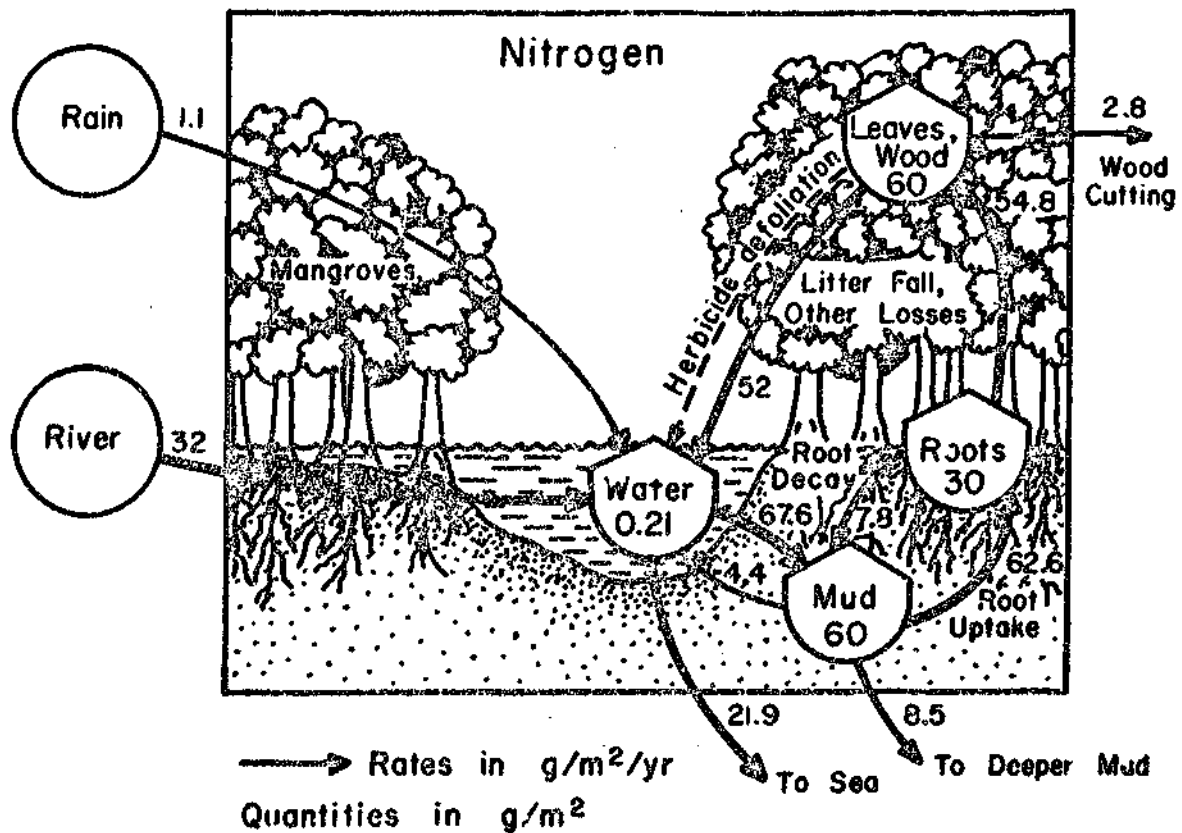

Figure 2. Summary of nutrient cycles in mangroves forests of the Rung Sat.

supply and wood cutting on mangrove reforestation (Fig. 3), and the impact of herbicide on the overall energy budget of Vietnam as a whole.

Herbicide and Other Effects on the Mangrove Ecosystem

Particular attention was given to the mangrove forest because the magnitude of disruption by the defoliation program was obviously greater than for other vegetative types, and because the most affected mangrove area (the Rung Sat) was available for field study to obtain basic information used in the systems model.

Before herbicide spraying (1958) about 51 percent of the Rung Sat was mangrove forest. The rest was water (22%), bare soil, brush, and agriculture. The fish and shrimp food chains in the waters were receiving organic matter from three sources: (1) three inflowing rivers, (2) the mangroves, and (3) photosynthesis of phytoplankton. The vigorous eight foot tide was exchanging the estuarine waters with the South China Sea every few days. Oxygen levels in the water were apparently between 5 and 6 ppm, which is slightly below saturation as expected where there is much consumption of organic matter inflowing from rivers and swamp. Acidity was in the range of pH 6-7 in low salinity zones, grading to the usual 8.2 in the open sea. There was a fishery using non-mechanized means by people in the mangrove areas. Waters were slightly turbid as characteristic of a river delta region.

Data available before spraying were used to make some inferences on the estuary and some inferences were made by a comparison of the waters in defoliated and non-defoliated sections of the Rung Sat.

After spraying, and as examined in 1972, defoliation and other changes due to war such as increased river traffic, dredging, and more use of motorized fishing vessels had affected the aquatic ecosystem in several ways. Increased turbidity of water due to organic detritus from decomposing mangrove and greater

siltation contributed to decreased phytoplankton and zooplankton, thereby lowering oxygen levels to between 3 and 4 ppm. There was no significant change in pH during this period. The total fish catch per unit effort of fishing vessel declined confirming information from interviews that stocks were down. Since motorized fishing has been introduced we do not know what part of the decline in fish catch per unit effort was due to overfishing, to loss of mangrove habitat, increased water turbidity, or other factors.

Because some of the foods for aquatic life in the estuary are being sustained by decomposition of the residual sprayed mangroves a continuing decline in this fraction of the estuary's nutritional status is anticipated. If there is a delay in recolonization of the mangrove area, there may be a delay in restoring the mangrove component to the fishery food chains. However, the fraction of detritus that comes from the river is not expected to change much, and phytoplankton contributions may increase again as turbidity decreases.

One major impediment to recovery of sprayed mangrove forests is the availability of young trees. Some mangroves, e.g. Rhizophora reproduce by means of large seedlings which do not drop from the parent tree until they are 8 inches long or more, others by nut-like fruits, e.g. Avicennia. In all types of mangrove the seedlings or nuts float and are dispersed by tidal water. In Rhizophora because the seedlings are large, relatively few can be produced by a tree in a year. In managed Rhizophora mangrove forest recommended practice for artificial regeneration is to start two seedlings per square meter. See Table 1. In the Rung Sat, few trees remain that are capable of supplying the quantity of seedlings or fruits required for early regrowth. Cutting for firewood is now concentrated in the small area of remaining mangrove so trees are kept scrubby with few large seed-yielding trees left. Only trees on the edges of water courses release a significant number of fruits or seedlings into water for distribution to bare areas. There is also a large mortality of fruits and seedlings between the time of release and establishment of a sapling tree.

Table 1

Seedlings Numbers for Reforestation of Rhizophora

Data on Seedlings	Seedlings per Acre
Recommended planting for reforestation ^a	8,000
Now sprouting in central Rung Sat by 1972 ^b	65
Number produced on an acre of larger, well-nourished trees ^c	28,000
Number surviving within a scrubby, cut-over forest in Vietnam ^d	14,400
Number reaching open water from seed source areas ^e	450
Number colonizing bare areas by calculation ^f	12
Computer Simulations (See Fig. 3)^g	
Number of seedlings starts from outside that must survive each year to achieve full canopy in 50 years	15
Number of seedlings starts from outside that must survive each year to achieve full canopy in 15 years	75

Footnotes to Table 1

- a Moquillon (1944), Noakes (1955).
- b Counts of seedling in 50 ground photographs taken in 1972.
- c Counts from Puerto Rico, Florida and Vietnam.
- d Counts at Vung Tau, March 1972.
- e Seedlings produced on the edge of tidal canals where ratio of canal margin to swamp area is about 2 m/100/m² and 83 seedlings overhanging per meter of canal per year; seedling area 100 Km² (Rookery Bay, Florida).
- f One-quarter reaching bare areas and 10 percent of these surviving.
- g Assumes seedlings are introduced from outside each year, and that the stated number of seedlings survives at least to the end of the first year, therefore to be subject to normal mortality. Regeneration will be to an extent determined by land uses.

In the central Rung Sat, the number of seedlings becoming established is only a tiny fraction of that required for rapid reforestation. Table 1 has some pertinent numbers on seedling sources and needs. A model of relationships of some main factors is given in Fig. 3a. Computer calculation of the seed production and distribution, seedling mortality, tree harvest and other factors shows that if seedlings are not supplied and if wood cutting of seed bearing trees continues the recovery time may be as long as 120 years. See Fig. 3b.

100 years could be saved by aerial broadcast of 1000 seedlings per acre, for 150,000 acres, or 150,000,000 seedlings. This would require the annual seed yield of 5,000 acres of mangroves broadcast over the bare areas of the Rung Sat. These calculations are based on aerial planting studies that suggest 10 percent survival of seedlings. If survival is less, more seedlings are required. If planted by ground labor, fewer seedlings would be required.

There was greater seedling survival in shaded spots than in areas exposed to full sunlight and drying, where mud temperatures reach 104° F. and briny conditions and compaction have developed as a result of defoliation on higher grounds.

One question that arises in any reforestation problem is the availability of plant nutrients, especially phosphorus and nitrogen. Defoliation was often followed by woodcutters who completely removed the woody parts of the mangrove trees, so that nutrients in the wood were removed from the system. Soil studies indicate this is a small fraction of available nitrogen, but for phosphorus it can be a larger fraction. However, the amount of phosphorus stored in mud and coming into the Rung Sat from the riverflow each year appears to be more than ample to supply the quantity required for reforestation. Note quantities of

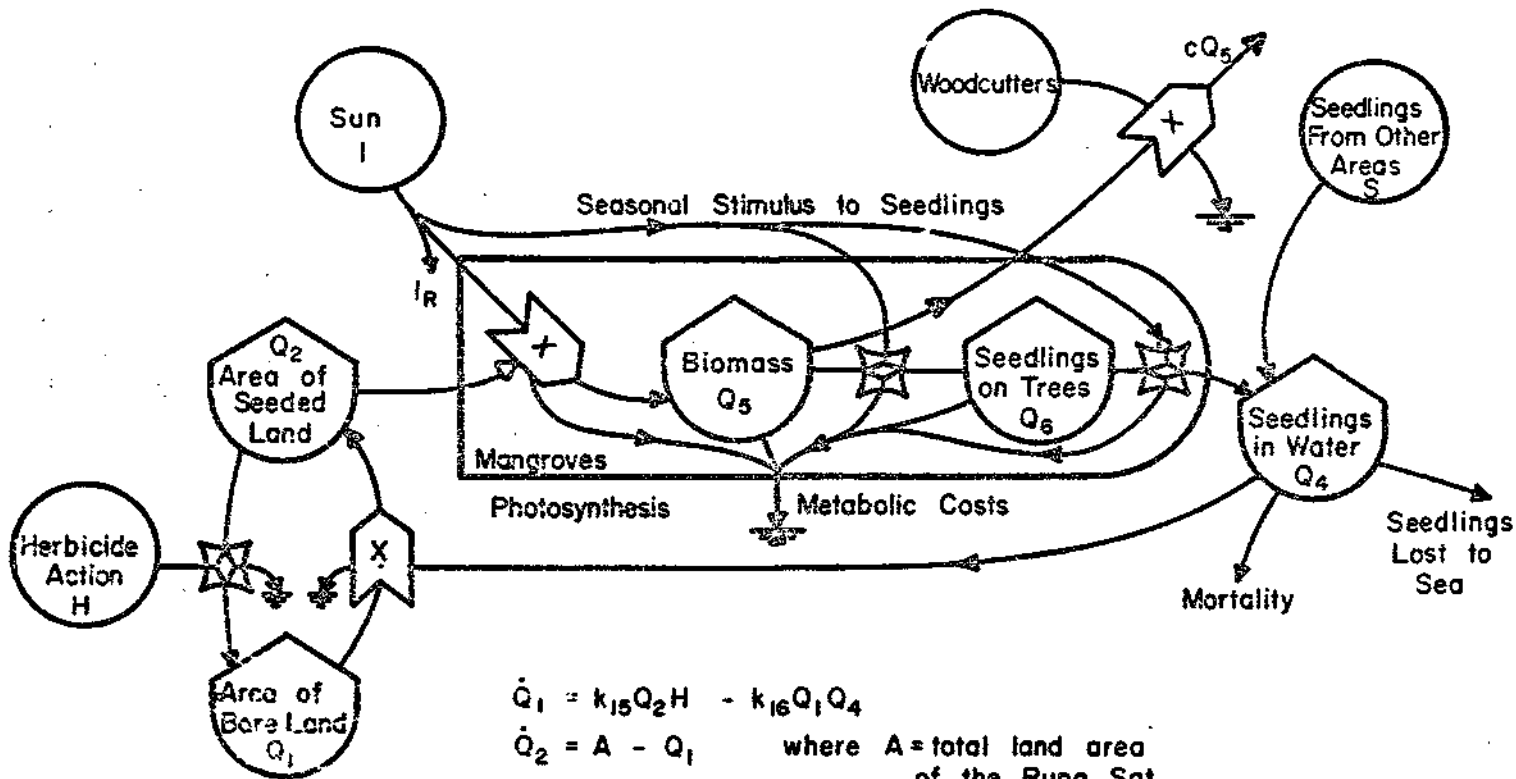

$$\dot{Q}_1 = k_{15}Q_2H - k_{16}Q_1Q_4$$

$$\dot{Q}_2 = A - Q_1 \quad \text{where } A = \text{total land area of the Rung Sat}$$

$$I_R = 1 - k_2Q_2I_R$$

$$\dot{Q}_4 = k_{11}Q_6 - k_{12}Q_4 - k_{13}Q_1Q_4 + S$$

$$\dot{Q}_5 = k_3Q_2I_R - k_6Q_5 - k_7Q_5 - cQ_5$$

$$\dot{Q}_6 = k_8Q_5 - k_{10}Q_6 - k_9Q_6$$

Figure 3a

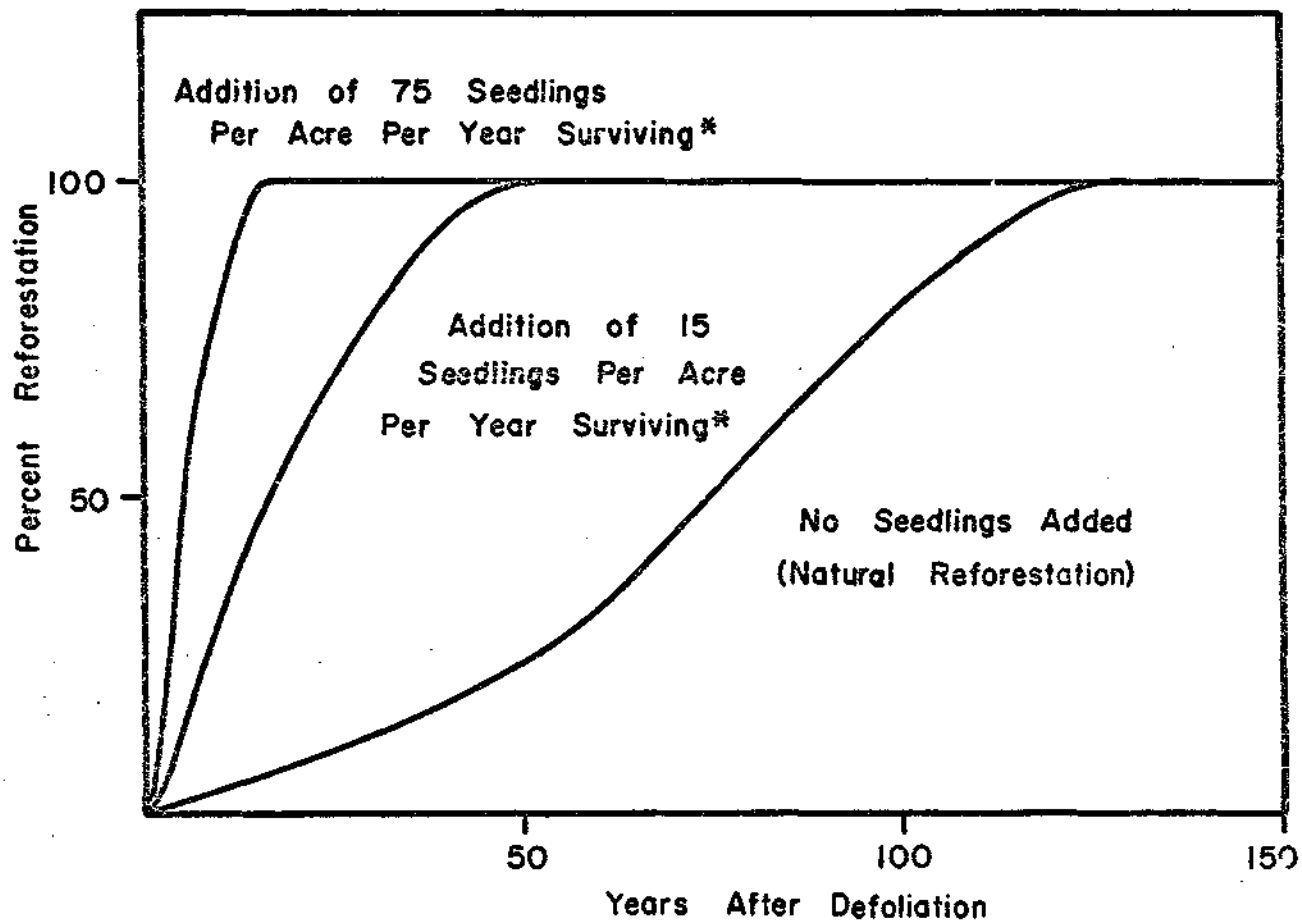

* 1 seedling out of 10 planted will survive

Fig. 3b. Computer prediction of reforestation of Rung Sat mangroves with and without planting by man. (Simulation diagram is in the section of Part B on modeling of Rung Sat mangroves.) Woodcutters harvest 3% of forest each year. Productivity of the forest is 16 tons per acre per year (1360 gms per m² per year).

phosphorus and nitrogen in leaves and wood in Fig. 2 as compared with that in mud and flowing in from the river each year. The measurement made in our sampling in sprayed areas showed adequate phosphorus held in soils. Thus, nutrients do not appear to be nearly so limiting as is seedling availability.

An Overall Energy Evaluation of Herbicide Impact

Viewing Vietnam's processes as a whole assists one in gaining insight into the relative magnitude of the main disruptive processes which are included as pathways of material and energy flow in Fig. 1. One way of doing this is to tabulate all of the main energy flows, constructive and destructive, those of nature such as the sun, and those of the cities such as fossil fuels. Energy of low quality such as sunlight is expressed in equivalents of chemical potential energy after the sunlight is transformed by photosynthesis. Expression of high quality energy such as work of human labor and urban technological economy is expressed in equivalents of fossil fuel required to generate this work.

The energy cost accounting method was used to estimate overall impact of military use of herbicides in South Vietnam. Energy effects produced by herbicides directly and indirectly were compared with the total energy budget of all SVN. The best data available to us for calculation of an energy budget are given in Tables 2 and 3. These data were used to construct a diagram of energy flow (Fig. 1) which shows the direct and indirect effects as they were used in calculations.

Figure 1 shows that the main inflows to the country are purchased fuels, military import of fuels, energy in rivers and tides, gross photosynthetic production in agriculture as stimulated by human activities using purchased inputs, and the very large photosynthetic production in natural vegetation, including upland forests, mangroves, and the coastal waters.

Table 2

Annual Energy Budget of Vietnam in 1965 and the Impact of Herbicide

Item	10 ¹² Kilocalories Per Year	Million Dollars Per Year Equivalent ^g	Effect of Herbicide	
			Interrupted Energy Per Year ⁺ 10 ¹² kcal/yr	Percent Change
Human Settlement (fuels) ^a	101	7,230	2	-2
Agriculture ^b	128	9,140	2.5	-2
Inland Forest ^c	1460	104,200		
Area Sprayed Once (1.2%) ^d			5.8	-0.4
Area Sprayed 2 Times or More (0.7%) ^e			5.8	-0.2
Mangroves ^f	61	4,360	4.9	-8
Estuarine Ecosystem Production ^g	29	2,072	1.8	-6.6
Energy in Rivers ^h	644	46,000	0	0
Tidal Energy ⁱ	152	10,860	0	0
Chemical Energy in Runoff ^j	119	8,510	0	0
Thermal Heating ^k	1680	120,800	0	0
Wind Absorption ^l	52	3,720	0	0
Total	4426	316,000	22.8	-0.5

Footnotes for Table 2

- * 14,000 kilocalories of chemical potential energy was estimated to be processed as work per dollar circulated.
- + Total spray acreages for five years of spraying were divided by 5 to obtain annual values of herbicide disruption.
- a Sum of purchased and military fuel imports. Purchased fuel imports were estimated as 10^3 metric tons and converted to calories of work by multiplying by 10^6 grams per ton and 10 kcal per gram. Military fuel imports were estimated as 10^8 barrels per year and multiplied by 10^6 kcal per barrel. Fuel use was estimated as disrupted 1.9% in proportion to 1.9% of the land area sprayed affecting human activities for the year.
- b Chemical potential energy entering the system each year as agricultural production was estimated by multiplying agricultural land (8×10^6 acres) by 4×10^3 to convert to square meters and by $40 \text{ kcal/m}^2/\text{day}$ of estimated gross photosynthesis and by 100 days estimated as the time crops were in leaf each year. Two percent was estimated of this area disrupted per year during spray years.
- c Chemical potential energy entering the system each year as gross photosynthesis of inland forest lands was estimated by multiplying area of vegetated lands (2.5×10^7) areas by $4 \times 10^3 \text{ m}^2/\text{acre}$ to convert to square meters and estimated averages, and then by hot synthetic rate including dry season ($40 \text{ kcal/m}^2/\text{day}$) and then by 365 days of green cover to obtain 1460×10^{12} kilocalories per year.
- d Herbicide disruption per year on single sprayed areas was estimated as defoliation of half of the leaves for half of the year on the 1.4% of forested land sprayed once per year.

- e Disruption on area sprayed twice or more was estimated as fifty percent of .7% of the forested area sprayed more than once per year.
- f Chemical potential energy contributed each year by mangrove photosynthesis was estimated as the number of acres (0.7×10^6) multiplied to convert to square meters ($4 \times 10^3 \text{ m}^2/\text{acre}$), multiplied by photosynthetic rate ($60 \text{ kcal/m}^2/\text{day}$) and multiplied by 365 days per year to obtain 61×10^{12} kcal/year.

Herbicide interruption was estimated to be half of the area of mangroves.

- g Chemical potential energy from estuarine photosynthesis was estimated as the product of the area (10^6 acres), converted to square meters ($4 \times 10^3 \text{ m}^2/\text{acre}$), the estimated photosynthetic rate ($20 \text{ kcal/m}^2/\text{day}$ using values from Galveston Bay which has similar turbidity) and the number of days per year (365).

Interruption due to herbicide was estimated as that part of the estuary within the herbicided area (about 33%).

- h Energy in rivers was estimated as the potential energy against gravity in the annual rainfall ($2\text{m} \times 1.72 \times 10^{11}$ square m in RVN) which is the volume times average height of RVN (800 m) times density of freshwater (10^3 kg/m^3) times the acceleration of gravity (9.8 m/sec^2) and multiplied by 2.39×10^{-4} to convert from joules to kilocalories.
- i Tidal energy was estimated as the potential energy of coastal water elevated and then absorbed in frictional work. Energy was estimated as product of water volume [estimated area of $1.45 \times 10^{10} \text{ m}^2$ times the height of the tidal range each day (6m including two tides per day)], the number of days per year (365), the average height of lifting water against gravity (2m), the density of water ($1.02 \times 10^3 \text{ kg/m}^3$), the acceleration of gravity (9.8 m/sec^2) and conversion from joules to kilocalories (2.39×10^{-4}).
- j The chemical potential energy in 1/3 of rain reaching sea in rivers reacting

with salts was estimated using expression for energy in one mole of water

$$\Delta F = \Delta F_0 + RT \ln(C_2/C_1)$$

multiplied by the moles of water flowing per year (water weight divided by the molecular weight, 18). Water was estimated as 2m times area ($1.72 \times 10^{11} \text{ m}^2$) times 1/3. Change in water concentration in joining the sea is that of a chemical from fresh to sea water $C_2 = .965$ and $C_1 = 1$, R is gas constant(1.98), and temperature is 300°K and $\Delta F_0 = 0$.

k Wind energy generated by temperature gradients generated by sun's heating and that due to downward diffusion of wind into the air space that may be counted is part of the country. If the heat gradient (ΔT) generated between land and air is maintained at 2°C the potential energy available to atmospheric heat energies is the product of the Carnot ratio and the Kelvin temperature (300°) and the total heat flux generated in absorbing the sun's energy ($4,000 \text{ kcal/m}^2/\text{day}$ times area $1.72 \times 10^{11} \text{ m}^2$) times 365 days.

l The energy from wind eddies that are externally generated was estimated as the kinetic energy at 300m times the eddy diffusion coefficient ($10^4 \text{ cm}^2/\text{sec}$) transferring momentum downward where it is absorbed in stirring the lower layers. The kinetic energy of a cubic centimeter is the product of half of the mass (air density 10^{-3} g/cm^3) times the square of the velocity (444 cm/sec) and the gradient is obtained by dividing by height of the layer (30,000 cm). For the whole country, multiply by area ($1.72 \times 10^{15} \text{ cm}^2$). To convert ergs to kilocalories multiply by 2.39×10^{-11} and for a year $3.15 \times 10^7 \text{ sec/yr}$.

Table 3
Cumulative Disruption Estimated 1965 Through 1985^a

Item	Disruption Per Year (See Table 2) 10 ¹² kcal/yr	Assumed Length of Time of Disruption Years	Cumulative Energy Disruption 10 ¹² kcal	Effect of Cumulative Disruption on Total Energy Economy ⁺ , Percent
Human Settlement ^b	10	1	10	0.03
Agriculture ^b	12.5	1	12.5	0.03
Inland Forest				
Sprayed Once ^c	29	0.5	7	0.02
Sprayed Twice or More ^d	29	10	218	0.61
Mangroves ^e	24.5	20 ^f	245	0.69
Estuarine Production ^g	9.66	5	<u>22.5</u>	0.06
Total ^h			515	1.44

Footnotes to Table 3

- a Estimated as the energy disrupted times the number of years disrupted.
- b Disruption was estimated as that in Table 2 (1.9% of the area for one year) times 5 such years.
- c Disruption was estimated as half of the production in Table 2 of area sprayed once (1.2%) times half of a year.
- d Disruption estimated as 3/4 of the production in Table 2 of area sprayed twice (0.7%) times 10 years.
- e Disruption was estimated as half of the production rate in Table 2 of the area sprayed (50%) for 20 years.

- f Assumes a seeding program to supply seedlings to bare areas.
- g Disruption based on half of the production in Table 2 for the area sprayed (1/3) for five years during period of decay and dispersion of turbidity.
- h Total energy budget in Table 2 (1780×10^{12} kcal/yr) times 20 years equals $35,600 \times 10^{12}$ kcal.

For that part of the system that has money exchange for value received one may list both money and energy budgets per year. These are pathways in Figure 5 that have a solid line (energy) and a dashed line (\$) running in opposite direction as payment for the work done. (Work is useful energy application.) For these parts of the economy, it is possible to calculate a ratio of money to energy flow which in SVN was about 14,000 kilocalories per U. S. dollar. Thus, if data for some part of the economy are in dollars one may estimate roughly the kilocalories of work done all through the economy in support of that work.

One may use the energy to dollar ratio in a reverse way to show money equivalent to the energy provided by nature in tides, ecosystems, photosynthesis, and other work for which there is no exchange of money. In Table 2 the second column has some dollar equivalents calculated with the energy/money ratio to give an appreciation of the amount of work provided by nature, which we often regard as "free." Agriculture gets part of its energy from the work of nature free of money charges so that its total dollar equivalent is larger than the money that exchanges in agricultural sales.

In the third column of Table 2, the impact of herbicide on the energy economy is given for one year as best we can estimate it from available data. Column 4 has the percent change due to herbicide. The total change estimated for herbicidal effect is 0.5 percent of the total energy budget for each of the years 1965-1971.

These calculations do not indicate whether a change is good or bad. For example some who advocate that mangrove lands be used for rice believe that mangrove clearing is good, whereas others regard the mangrove interruption as a loss. It depends on what land use is intended in the future. There is also the energy value of ships to and from Saigon not sunk because of clearing the mangroves.

The herbicide disruption was estimated in Table 2 for one year. The total effect depends on the time required for recovery. If energies are

available for reconstruction restoration may be rapid. The creation of disrupted lands stimulates the recovery of these lands since they are susceptible to reorganization by new energy flow. In the mangroves special factors of seed shortage delay recovery. In Table 3 the time for restoration of the canopy is used to estimate the cumulative effect from time of spraying until recovery of photosynthetic activity. For inland forest and agriculture defoliated after one spraying this has been assumed to be one season or less since only part of the canopy was defoliated and most trees have enough reserves to refoliate once. For mangroves restoration of canopy takes much longer.

The duration of mangrove interruption depends on delays in a decision of whether to add seedlings or put the land to another use. The interruption that is attributable to herbicides is calculated to the present. Future delays in making a decision may result in a delay in attaining full productivity of the Rung Sat, but productivity losses due to delays in making a decision cannot be necessarily attributed to the herbicide.

The model in Figure 1 was simulated on computer to obtain curves of overall value in energy units during the period of recovery, a time when other energies were also varying due to the war. Figure 4 shows one of the computer graphs suggesting the overall shape of interactions with and without herbicide. For the assumptions made about the factors controlling growth and for the data used the graph shows future patterns in Vietnam with and without the herbicide effort.

In the last column of Table 2 the time of energy interruptions was combined with amount of energy interruption per year to obtain an estimate of the overall cumulative effect to 1980 on the energy budget of SVN. This was shown to be 0.6 percent. An analysis of the entire system shows that the largest energy input of the defoliation program has been the destruction of mangroves. If during the same period the energy increase due to U.S. aid were estimated at 500 million dollars per year the effect in increasing energy value would be

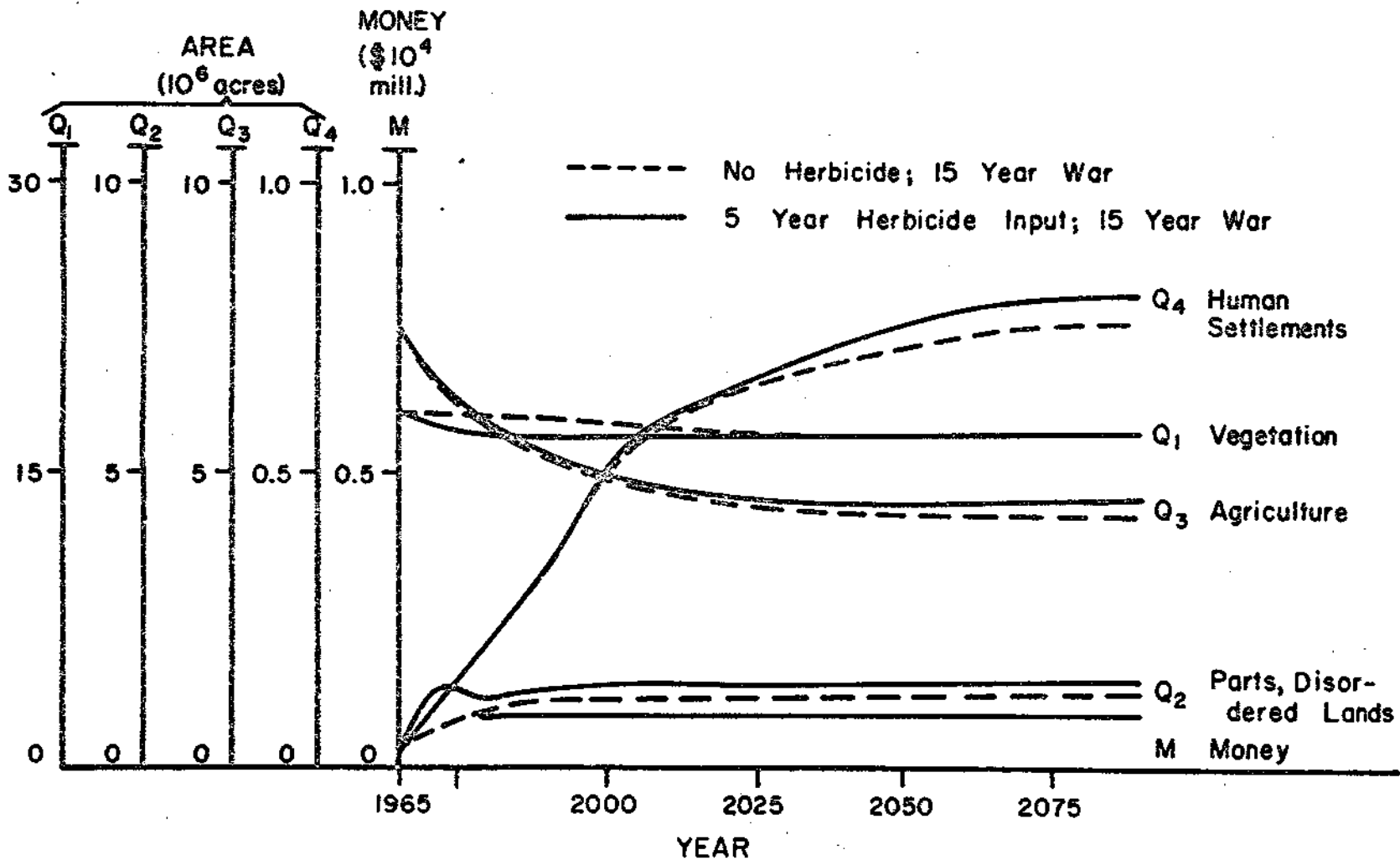

Fig. 4. Simulation results of model depicted in Fig. 1 for the cases of no herbicide and 5-year herbicide pulse.